



**SE 2.5i-F**



**Shop manual**

# CONTENTS

Forward .....	2
Motor tools SE25i-F .....	3
Technical specification - Motor .....	4
Technical specification - Frame .....	5
Standard adjustment – Fork .....	6
Standard adjustment – Shock absorber .....	7
Operations requiring demounting or not engine .....	8
Removing the motor .....	9
Motor top end .....	11
Disassembling the right side .....	12
Disassembling the left side .....	12
Crankcase / Transmission / Central crankcases .....	12
Tightening torques .....	12
SHERCO diagnostic tools .....	12
Software installation .....	12
Software presentation (the various interfaces) : .....	12
Connecting the diagnostic kit wiring .....	12
Performing diagnostic .....	12
Synchronizing the ECU / with the butterfly opening sensor (TPS) .....	12
Electrical installation checking .....	12
Regulator .....	12
Cable diagram (Injection / light) .....	12
Injection beam .....	12
Light beam .....	12

## **Forward**

This manual is designed primarily for skilled mechanics working in a properly equipped workshop. The execution of the operations in this manual requires a strong mechanical knowledge and specific SHERCO tools designed for the 2.5iF SE engine.

This workshop manual is a supplement to the SHERCO SE 2.5iF owner's manual.

# Motor tools SE25i-F

Tool ref	Designation
1819	Dead point
1814	Clutch holder tool
1815	Ignition tool
2067	Swingarm tool
2068	Freewheel tool
2069	Oil seal tool (Gear box exit)
2070	Oil level gauge tool
2071	Bearing tool 6905 (Gear selector drum)
2072	Bearing tool 6222 (Clutch shaft)
2079	Bearing tool 6203 left ( Balancer)
2080	Oil seal tool 8x18x5
1822	Bearing tool (Water pump shaft)
2078	Oil seal 36x57x7,5 Right (Crankshaft)
2077	Bearing tool 4905 Right (Balancer)
2074	Bearing tool 6003 (Gear shaft)
1968	Oil seal tool (Water pump)
2075	Piston tool
2076	Bearing tool (Crankshaft)
1816	Ring tool
1821	Engine support tool 250
1817	Pinion tool
1818	Piston support
2073	Resort tool
R462	Flywheel puller
R464	Ring extractor
R450	Gear selector oil seal tool

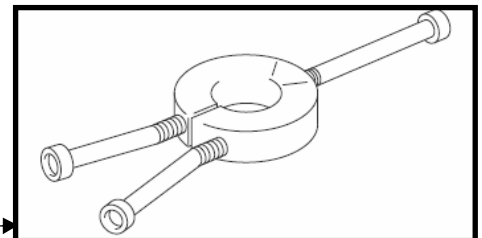
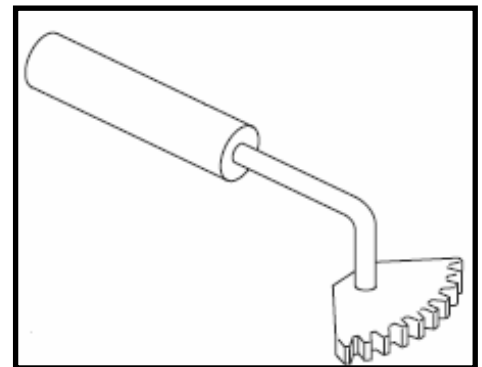
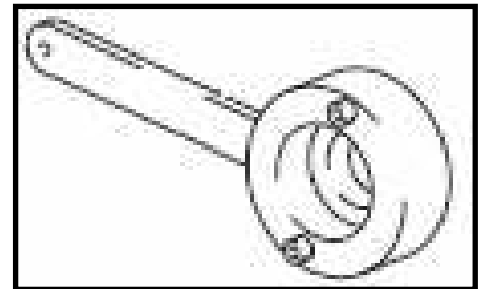
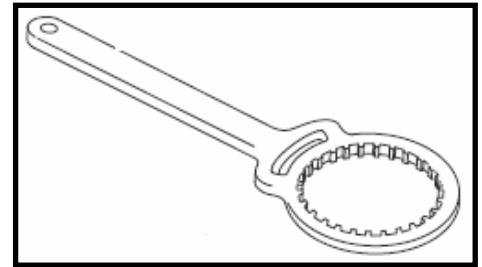
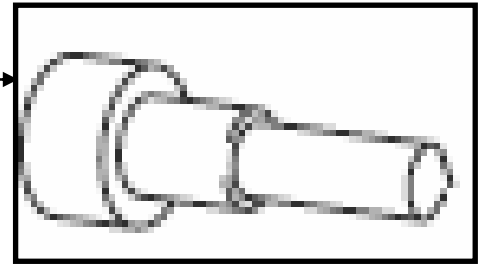

## Technical specification - Motor

Type	Liquid cooled single cylinder 4 strokes engine
Displacement	249.4 CC
Bore/Stroke	78/52mm
Compression ratio	12.6 :1
Fuel	Without lead 95 or 98
Valve timing	4 valves, DOHC driven by tooth type chain
Admission valve diameter	29mm
Exhaust admission valve	25mm
Thickness admission valve	0.15-0.2mm
Thickness exhaust valve	0.2-0.25mm
Crankshat bearing	2 roller bearing
Piston	Aluminium forge
Lubrification	Lubrication under pressure with 2 trochoidal pumps
Motor oil	1 L SAE 10W60
Primary reduction ratio	21 :70
Gear box :	6 speed
1ère	13 : 34
2ème	16 : 31
3ème	19 : 28
4ème	21 : 26
5 ème	23 : 24
6 ème	25 : 22
Clutch	Multi-disk in oil bath. Hydraulic command
Ignition system / Batterie	Electric start/12V 6.5Ah
Electronic injection	Magneti Marelli

## Technical specification - Frame

Frame	Central tube Chrome-moly-steel frame
Fork	Paiöli USD Ø 46mm
Rear suspension	Sachs with separated tank, aluminium swingarm
Travel Front/rear	300/300mm
Front brake	disc Ø 270mm
Rear brake	disc Ø 240mm
Brake disc	2.5mm Front and 3.5 rear (tichkness mini)
Front tire	90/90-21''
Rear tire	140/80-18''
Pressure TT	1 bar
Fuel tank capacity	7.5l
Secondary reduction ratio	13 : 48
Angle of the steering column	27.6°
Wheel base	1485mm
Weight (with fuel)	114.7 kg

## Standard adjustment – Fork

Compression	Turn clockwise to the stop, then back of 14 clicks
Rebound	Turn clockwise to the stop, then back off 12 clicks
Spring	4.2N/mm
Fork oil	SAE 5
Oil capacity	580cm <sup>3</sup>
Oil level	110mm

## Standard adjustment – Shock absorber

Compression	12 clicks (Slow compression) 12 clicks (Fast compression) Turn clockwise to the stop, and then back off...
Rebound	7 clicks
Spring	52N/mm
Oil capacity	SAE 5



## Operations requiring demounting or not engine

	Removing engine	Not demounting engine
Crankshaft	•	
Gear box	•	
Crankshaft bearing	•	
Gear Box bearing	•	
Piston		•
Cylinder		•
Cylinder head		•
Valve timing		•
Ignition		•
Pinion of ignition system		•
Freewheel		•
Clutch		•
Water pump		•
Oil pump		•
Gear selection		•

# Removing the motor

## Removing the motor:



To remove the engine, you must remove the swing arm axle, the swing arm and the rear wheel. To keep the bike from falling, remember to support the chassis with an appropriate jack.

- Drain (refer to the owners manual)
  - the engine oil
  - the engine coolant
- Remove the seat.
- Disconnect the battery.
- Remove the fuel tank and its covers.
- Disconnect all the electrical wiring connectors from the engine. (Starter, TPS sensor, water temperature sensor, coil, fuel injector).
- Remove the exhaust.
- Remove the ignition coil.
- Remove the fuel injector body.
- Remove the chain.
- Remove the chain guard.
- Remove the clutch actuating cylinder.



When the clutch actuating cylinder is removed the piston is loose. Hold the piston in place using a plastic strap.

- Remove all of the water hoses connected to the motor.
- Remove the left radiator.
- Loosen all of the engine bolts [A].
- Loosen the swing arm bolt.
- Remove the brackets that attach the cylinder head to the chassis.
- Remove the motor mounting bolts.
- Remove the swing arm bolt.
- Remove the motor.

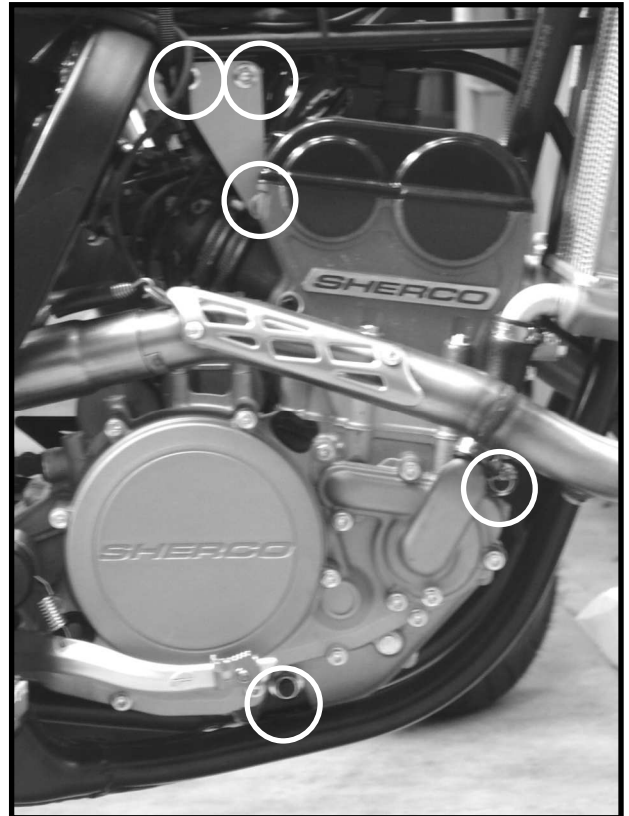

Reinstalling the motor:

- The motor should be reinstalled in the frame in the reverse order of how it was removed. The following torque values should be utilized.

**Tightening torques :**

**Motor mounting bolts : 40Nm**

**Swing arm axle nut : 100 Nm**

**Clutch receiver screws : 10 Nm**

**Cylinder head bracket bolts : 23Nm**

**Exhaust mounting bolts : 10Nm**

# Motor top end

For additional details refer to the parts catalog chapter.

## Removing the cylinder head:

- Remove the spark plug.
- Remove the valve cover.
- Remove the three valve cover screws.



These three screws are equipped with o-rings ref: 0900.

- Remove the cap from the ignition cover.

[A].

- Remove the timing control plug [A]
- Turn the engine counterclockwise in order to align the timing marks on the crankshaft with the marks on the timing gear. Install the special tool that locks the engine at Top Dead Center [A] (ref 1819)

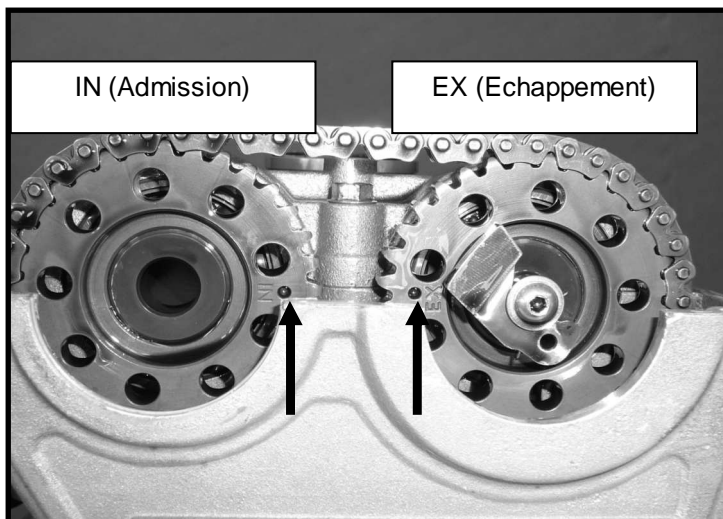
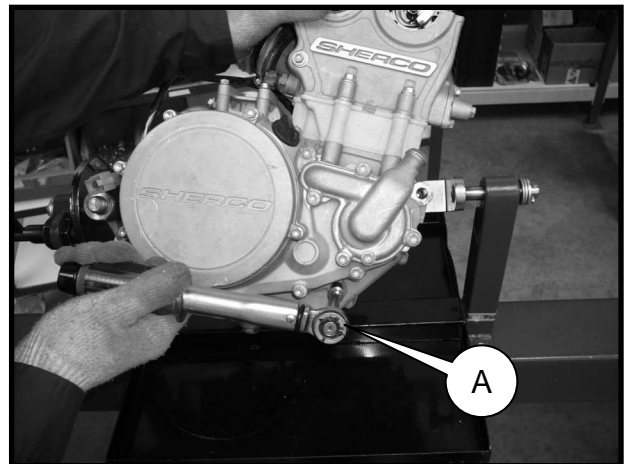
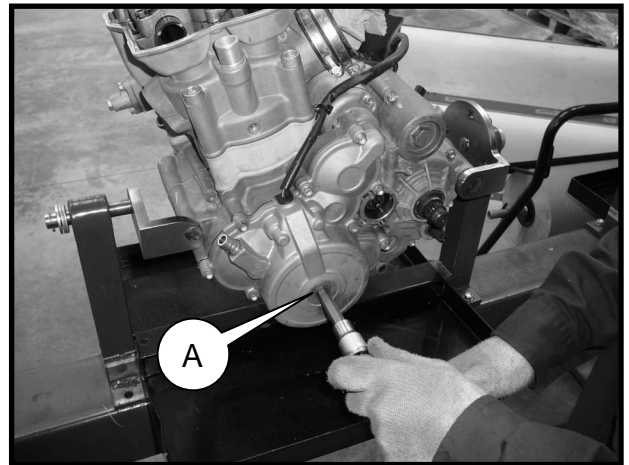

The timing marks should align with the joint.

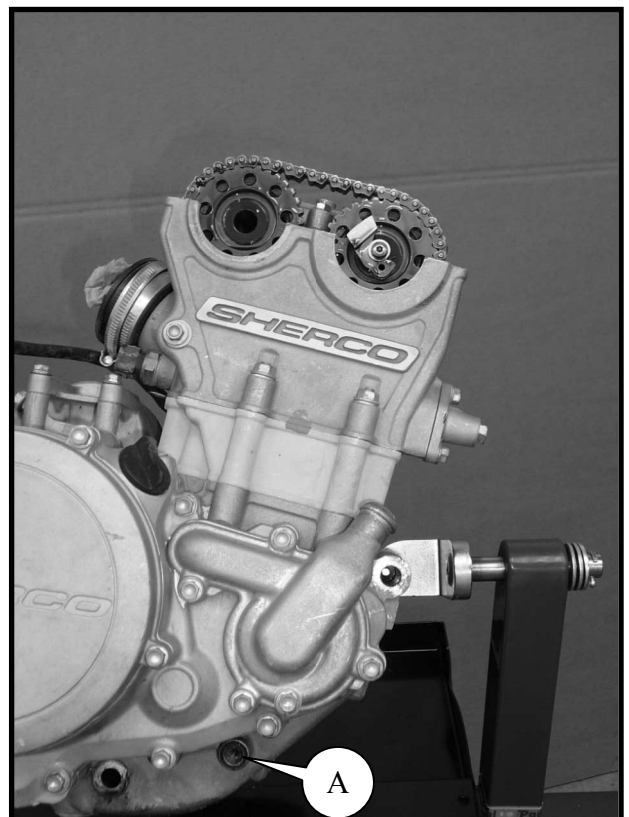

- Remove the screws from the cam chain tensioner as shown in the photo.
- Remove the cam chain tensioner.
- Remove the spark plug well.

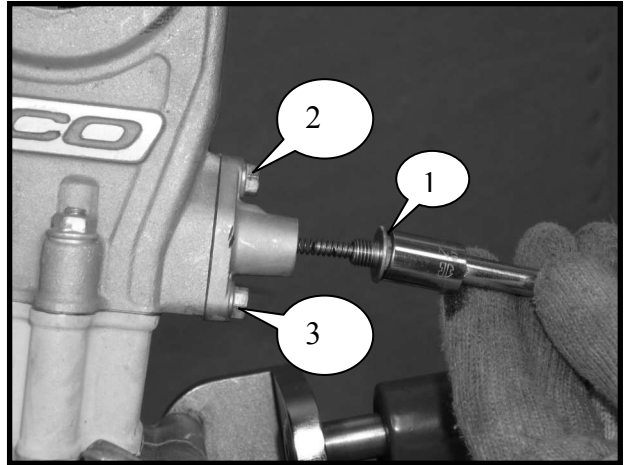

- Remove the camshaft bearing journal. Starting on the inside, remove the screws in a criss cross manner (see the numbers on the photo).

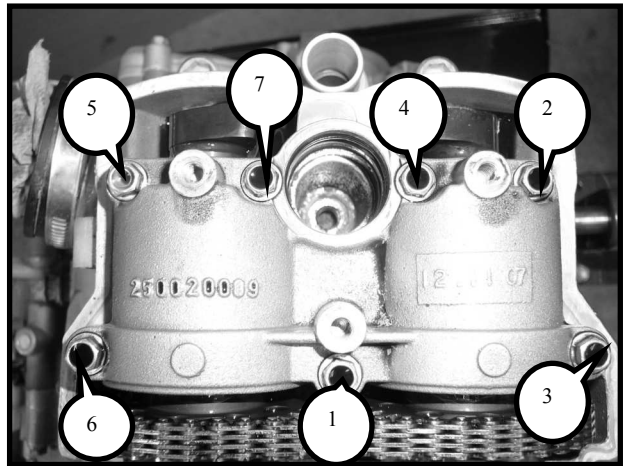

- Remove the exhaust camshaft retaining clip.
- Remove the exhaust camshaft.
- Remove the intake camshaft retaining clip.
- Remove the intake camshaft.

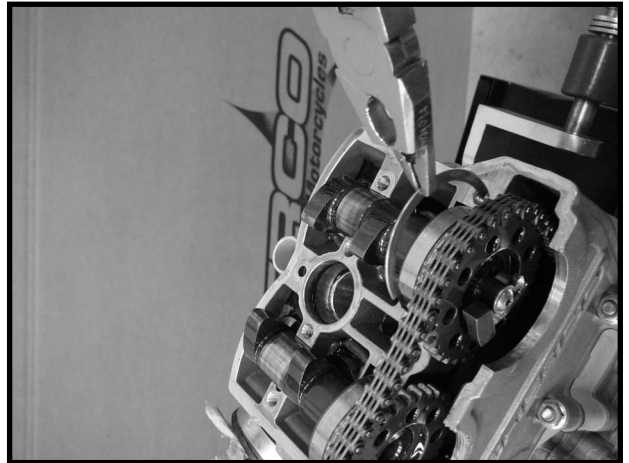

- Remove the two nuts M6.

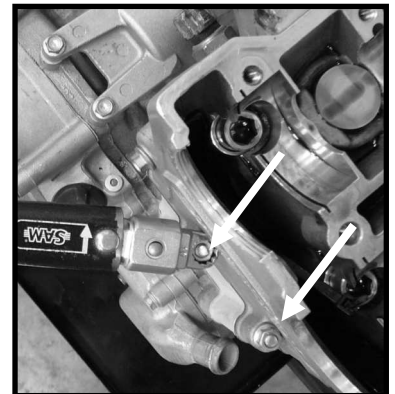

- Remove the cylinder head bolts (Be sure to loosen them in the correct direction).



3 bolts are identical and one is longer (No. 1 in the photo).

There are washers on N°1 and N°3.

- Remove the cylinder head.
- Remove the head gasket and the cylinder.

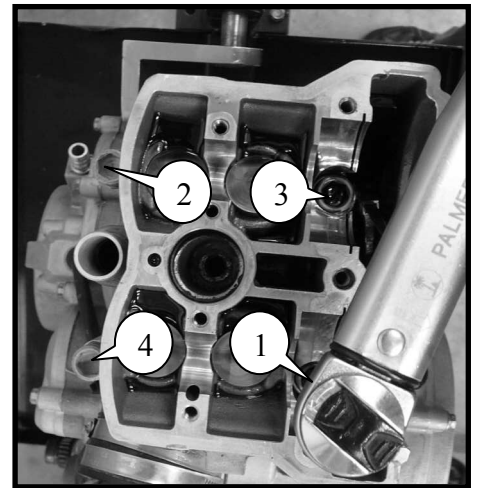

### Motor top end:

#### Inspection of the cylinder for wear:

Measure the inside diameter of the cylinder when it is cold.

- Inspect the inside of the cylinder for any scratches or other evidence of abnormal wear. If the cylinder is badly damaged or worn it should be replaced.
- Since the cylinder does not wear in a uniform manner measure in from side to side and up and down as shown. If the inside measurement of the cylinder exceeds the tolerance limit it must be replaced.

(A)=10 mm

(B)=25 mm

#### **Standard:**

**Cylinder diameter (A) = 77.982±0.01 mm**

**Cylinder diameter (B) = 77.982~77.995 mm**

**Taper limit 0.05 mm**

**Out of round limit 0.05 mm**

#### Piston / cylinder clearance

To determine the piston / cylinder clearance as accurately as possible it is sufficient to measure the piston and the cylinder, and then calculate the difference between the two values. Measure the diameters as shown.

#### **Piston / cylinder clearances**

**Standard 0.03 – 0.05 mm**

**Limit 0.10 mm**

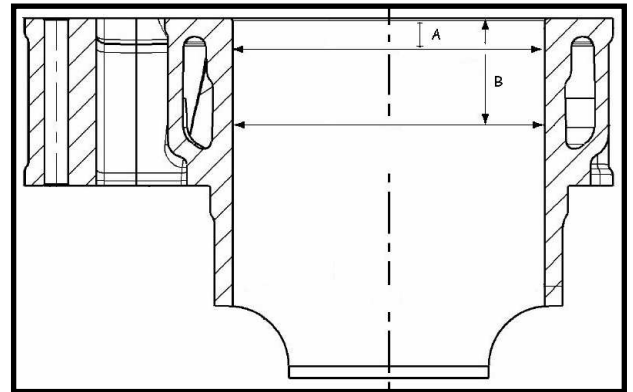

Piston wear:

- Using a micrometer measure the outside diameter of the piston [A] 10mm [B] above the bottom of the piston and at right angles to the axis of the piston.

If the outer diameter of the piston is below the tolerance it must be replaced.

**Piston =  $77.940 \pm 0.005$  mm**

Ring groove / piston ring:

- Using a feeler gauge measure the clearance between the piston ring and the ring groove.

- Check in several places to determine the actual clearance if the clearance is greater than the maximum, replace the piston ring and if necessary the piston.

**Ring groove / piston ring****Standard**

**Compression ring: 0.030-0.065 mm**

**Limit 0.13 mm**

**Oil control ring: 0.020-0.055 mm**

**Limit 0.13 mm**

Ring end gap

**Compression ring: 0.3-0.4 Limit 0.7 mm**

**Oil control ring: 0.3-0.5 mm**

Inspect the connecting rod, the piston pin and the piston for wear:

- Visually inspect the circlips in place. If they appear worn or distorted replace them. If the hole for the circlips appears worn replace the piston.

- Measure the piston pin with a micrometer.

If at any place on the pin the diameter is below the limit replace the piston pin.

- Measure the diameter of the piston pin holes in the piston and the hole in the connecting rod. If the one or more holes in the piston are incorrect replace the piston.

If the diameter of the hole in the connecting rod is incorrect, replace the connecting rod.

**Piston pin diameter**

**15.997-16.000 mm**

**Piston pin hole diameter in the piston**

**16.004-16.009 mm**

**Connecting rod hole diameter**

**16.000-16.011 mm**

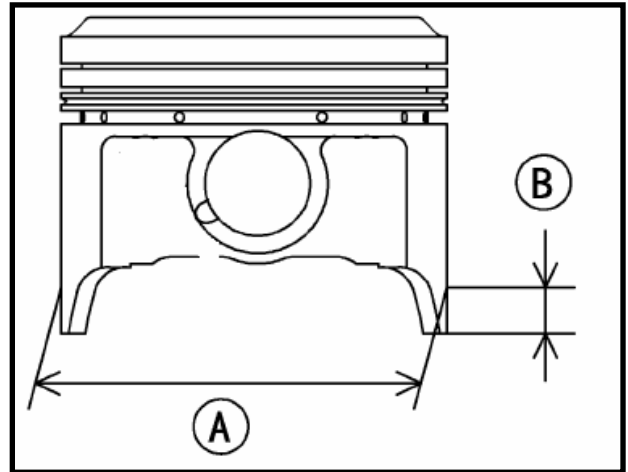

Check the camshafts for wear:

- Remove the camshafts.
- Measure the heights [A] of the camshaft lobes with a micrometer.

If the cams are worn beyond the limits, replace the cams.

**Camshaft height limit**

**Exhaust: 31.40 mm**

**Intake: 32.28 mm**

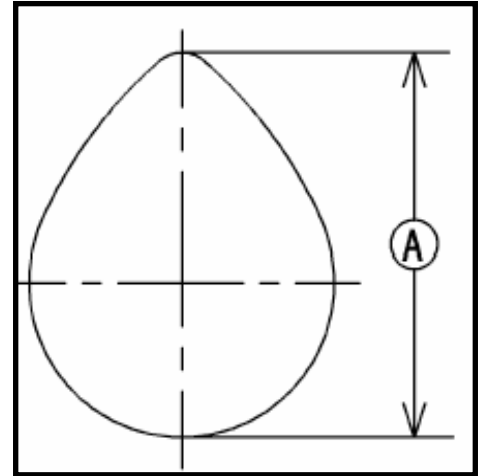
Checking the camshafts and camshaft journals for wear:

- Measure the clearance between the camshaft and the camshaft journals using plastigage [A].

Lubricate the fixing bolts with engine oil and tighten to the proper torque.

**Tightening torque**

**Camshaft journal mounting bolts: 10 Nm**

If any of the measurements are over the limit, then measure the diameter of each journal.

**Camshaft / journal clearance**

**Standard: 0.020 – 0.062 mm**

**Limit: 0.15 mm**

If the diameter of the journal is below the limit replace the camshaft and measure again.

**Camshaft journal diameter**

**Standard: 22.967 – 22.98 mm**

**Limit 22.938 mm**

If the clearance is outside of the tolerance limits, replace the entire cylinder head.

Eccentricity of the camshaft:

Measure the camshaft runout.

If it is out of tolerance, replace the camshaft.

**Runout: Less than 0.03 mm**

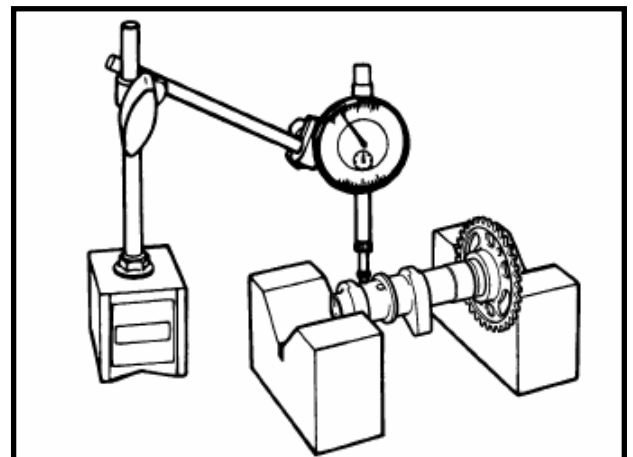
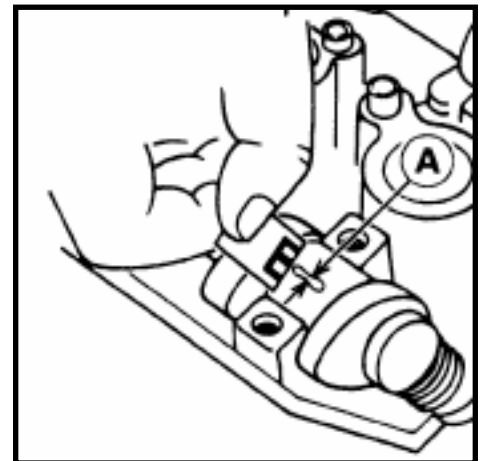



Inspect the cylinder head for flatness:

- Place the cylinder head on the workbench
- Using a precision straight edge [A] and a feeler gauge check the head for warpage; check in several places as shown in the photo. If the warpage is above the limit, repair if possible, if the damage is severe replace the head.

**Cylinder head warpage:**

**Limit = 0.05 mm**

Visually inspect the timing chain for damage:

Inspect the timing chain by flexing it to determine if there are any tight spots. If tight spots are found it should be replaced.

Check the automatic chain adjuster and make sure that it is not in the last ratchet notch.

Visually inspect the cam tensioner guides:

Visually inspect all of the cam chain tensioner channel guides and pads including the ones on the cylinder head cover.

Change as necessary.

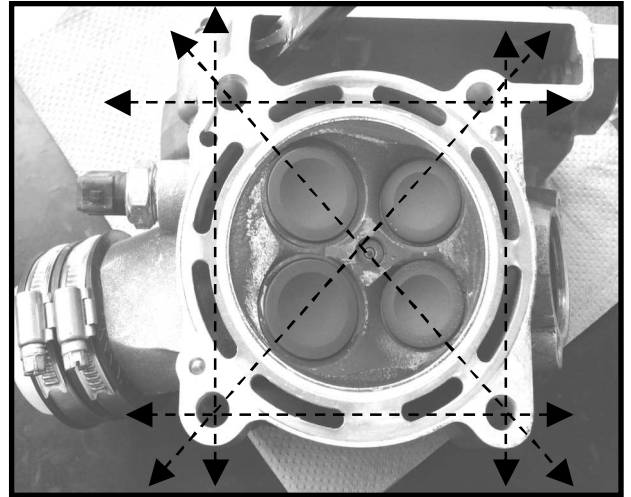

### Reassembling the top end of the motor:

#### Reassemble the piston

- Install the piston rings on the piston with the end gaps as shown in the photo, the compression ring goes in the top groove and the oil control ring goes in the bottom groove.

A Lower expander end gap  
 B Lower piston ring end gap  
 C Upper expander end gap  
 D Upper piston ring gap



**ATTENTION** The expander rings do not have a top or bottom; however the oil control ring and the compression ring must be installed with the « N » mark facing up.

- Apply engine oil to the wrist pin internal bore in the piston.
  - Carefully note the piston orientation (the small cut outs are on the exhaust side)
  - Install the locating pins [B].
  - Install the base gasket [C].
  - Use special tool number 1821 to maintain the piston in the correct location [A].
- 
- Place one of the cir clips in the special tool number 2075 as shown in the photo; install the clip close to one end of the tool.

- Use the tool to set up the clip for installation on the wrist pin.
- Install the cir clip on the wrist pin.

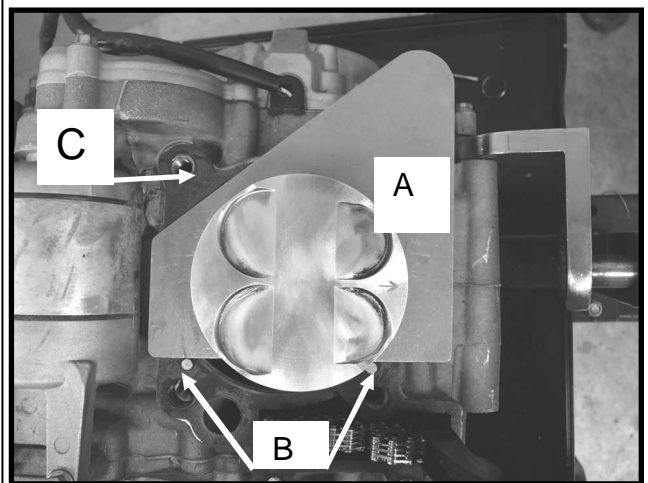
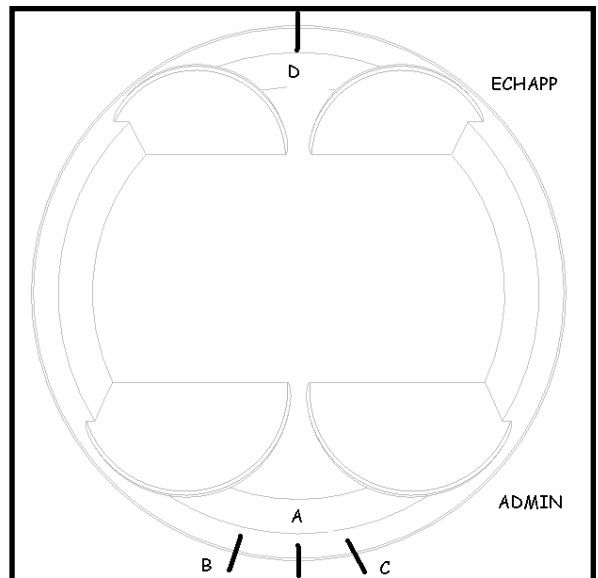

- Install the wrist pin into the piston and connecting rod using the tool and lightly tapping with a hammer.
- Install the opposite circlip, using the special tool.
- Install the cylinder over the piston using an appropriate ring compressor.

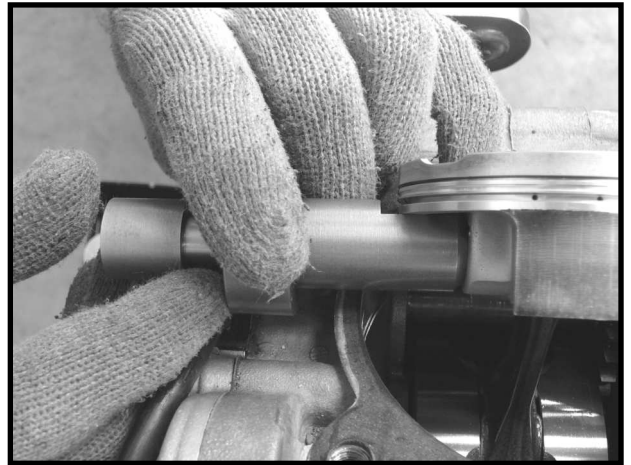

- Install the two cylinder head locating pins [A].
- Install the head gasket [B].
- Install the cylinder head.

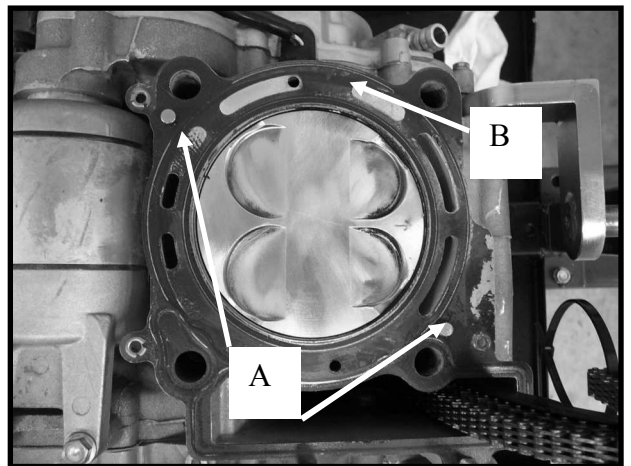

- Install the head bolts noting the different lengths; tighten them using two passes in the order shown in the photo.
- Install and tighten the two M6 nuts.

**Cylinder head torque:**

**Studs**      1<sup>st</sup> pass: 30 Nm  
                   2<sup>nd</sup> pass: 50 Nm

**Nuts M6: 10 Nm**



**ATTENTION** The two internal bolts are of different length and are equipped with washers.

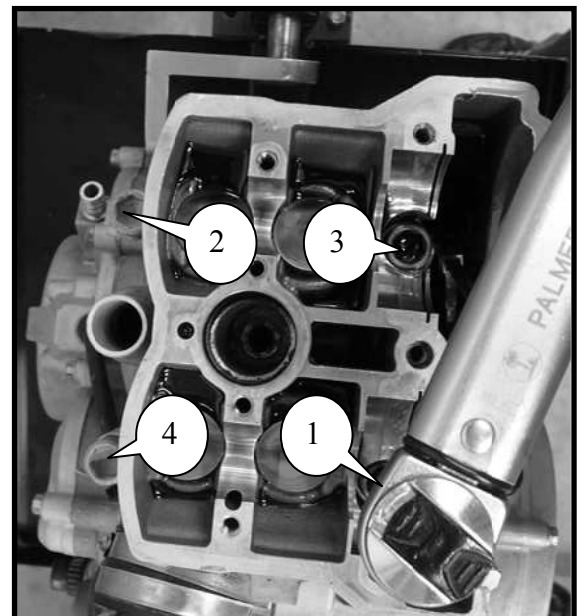

Valve timing:

- Verify that tool number 1819 is still properly installed.
  - Install the intake cam.
  - Install the exhaust cam.
- (see the photo for how to set the timing marks)

- Install the camshaft retaining clips.
- Apply moly disulfide grease to the camshafts.
- Install the camshaft retaining cover. (pay careful attention to the tightening order).

**Camshaft retaining cover torque**  
**10Nm**

- Install the camshaft chain tensioner using a new gasket.

**Torque the two fixing bolts to:**  
**10Nm**

- Install the cam tensioner adjusting bolt (pay attention to the o-ring).

**Torque the tensioner adjusting screw to:**  
**10Nm**

- Remove the special tool number 1819.
- Rotate the engine a few times to make sure that the valve timing is correct.
- Finally check the valve timing using the timing marks.
- Replace the cap that was removed to install tool number 1819.

**Torque the cap to:**  
**8Nm**

- Replace the spark plug well.



**ATTENTION** Make sure that the o-rings are installed on the spark plug well.

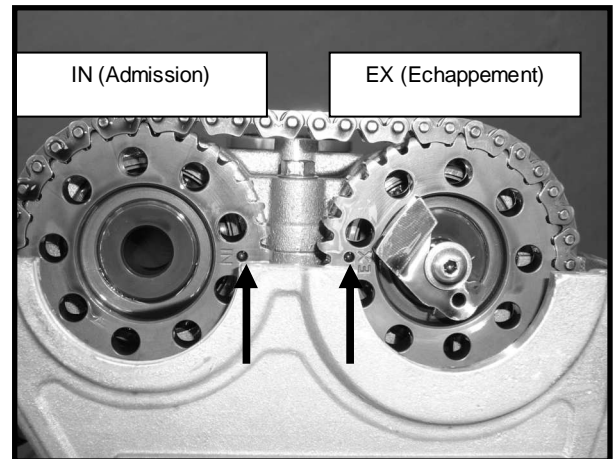

The timing marks should align with the joint

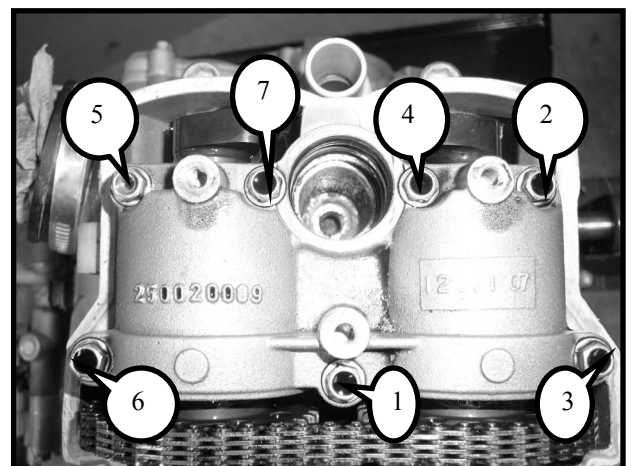
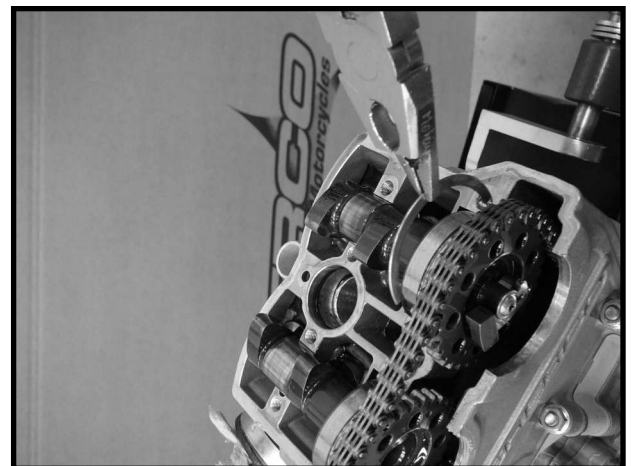

- Apply a thin coat of silicone to the camshaft end cap bores.
- Replace the valve cover.
- Install the valve cover installation bolts.

**Torque the bolts to:  
8Nm**

#### Checking the valve clearance:

- The valve clearance must be checked when the engine is cold.
- Remove the spark plug and the valve cover.
- Remove the timing plug from the crankcase.
- Install special tool number 1819.
- With a feeler gauge measure the clearance between the bucket and the cam.

#### **Valve clearance**

**Intake      0.15 – 0.20 mm**

**Exhaust    0.20 – 0.25 mm**

- If the clearance is not correct then change the discs in order to obtain the correct gap.
  - Remove the discs with a magnet.
  - Measure the thickness of the disc and replace with one of the correct thickness.
- Select the appropriate disc from the existing parts catalog.**

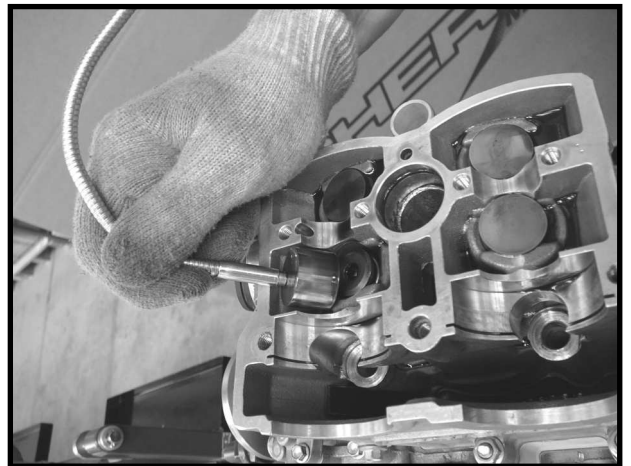
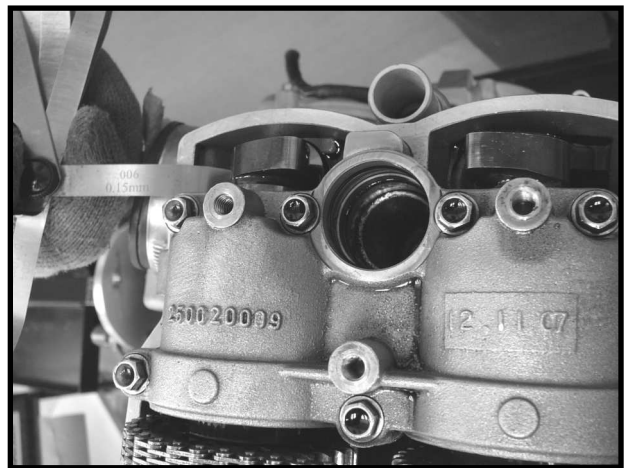
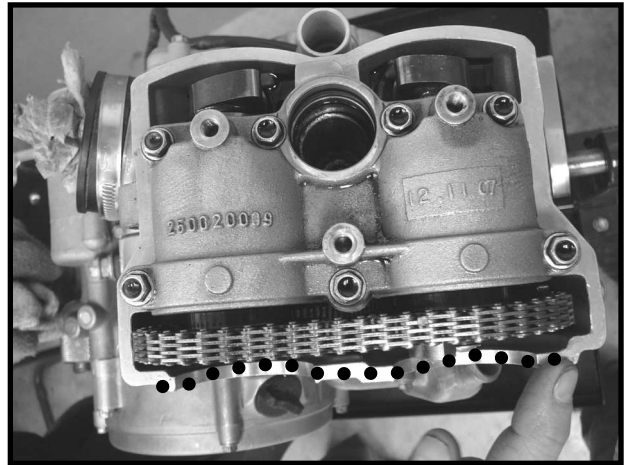

### Replacing the cam chain:

- Remove the camshafts (see the chapter on the motor top end).
- Remove the clutch cover (see the chapter on « Right side » removing the clutch).
- Remove the chain tensioner adjuster.
- Remove the cam chain.
- Inspect the cam chain (see « visually inspecting the cam chain »).
- Install the cam chain in the opposite manner in which it was removed.
- Reinstall the cam tensioner bolt and tighten to the correct torque.

**Torque the cam tensioner bolt to:  
10Nm.**

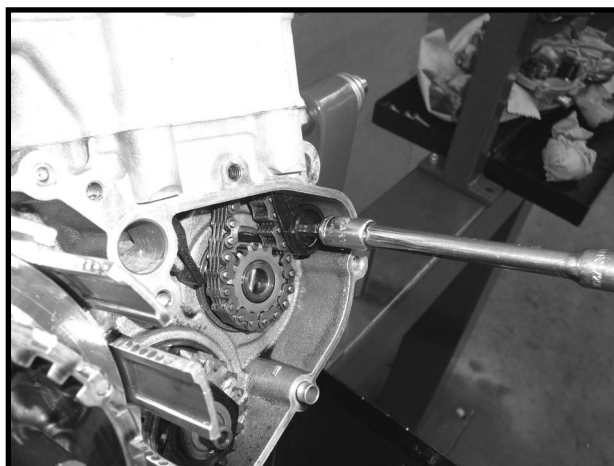

## Disassembling the right side

For additional details see the parts catalog 250i .

### Clutch dismantling:

- Install special tool number 1819.



Only use this tool for disassembling the clutch, do not use it to remove the hub fixing nut.

- Remove the 4 screws that retain the clutch cover.
- Remove the 5 pressure plate screws (see the photo).
- Sort the discs and make sure they are trimmed and smooth.
- Make sure that the clutch hub rotates freely.

### Inspect the clutch:

- Inspect the discs to make sure they are trimmed and smooth.

#### **Friction plate thickness**

**Standard: 2.95**

**Limit: 2.7**

**Deformation limit: 0.3mm**

#### **Steel disc thickness**

**Standard: 1.4**

**Limit: 1.3**

**Deformation limit: 0.3mm**

### Check the clutch spring length:

- Measure the free length of the clutch springs.

**Standard: 37.5mm**

**Limit: 36.5mm**

### Reassembly of the clutch:

- Soak the friction discs in engine oil.
- Replace the discs on the hub by starting with a friction disc and then a steel disc ending with a friction disc.
- Replace the pressure plate.
- Install the 5 springs.
- Install the 5 screws and tighten in an alternating order (see the disassembly photo).

**Torque the screws to:**

**10Nm**

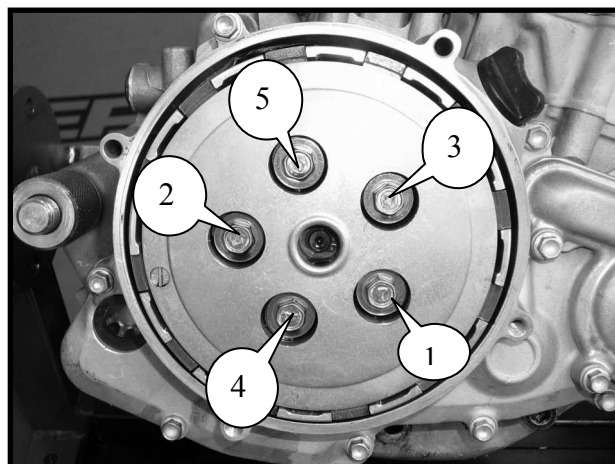

- Reinstall the clutch cover, inspect the o-ring and replace if it is damaged.

#### Disassembling and inspecting the water pump:

- Drain the coolant by removing screw [A].
- Remove the screws from the water pump housing.
- Remove the water pump impeller using a 10 mm socket.



If the seal is leaking, coolant will come out of the weep hole (see photo). In order to change the seal the clutch housing must be removed.

#### Changing the water pump shaft seal requires removing the clutch housing:

- Remove the clutch housing.
- Remove the clip from the water pump shaft.
- Remove the water pump shaft.
- Remove the roll pin.
- Heat the clutch case in an oven to 70°.
- Extract the bearing.
- Change the seal using special tool number 1968.



Attention makes sure the seal is installed properly, you should see the spring when you look at the seal. (see photo).

- Check the bearing, if it requires changing use special tool number 1822.
- Reinstall the parts in the reverse order of their removal. Pay careful attention to the clutch housing locating pins, always install a new paper gasket and if necessary install a new o-ring seal on the water pump housing.

**Tighten the water pump housing screws to: 11Nm.**

**Tighten the coolant drain plug to: 6Nm.**

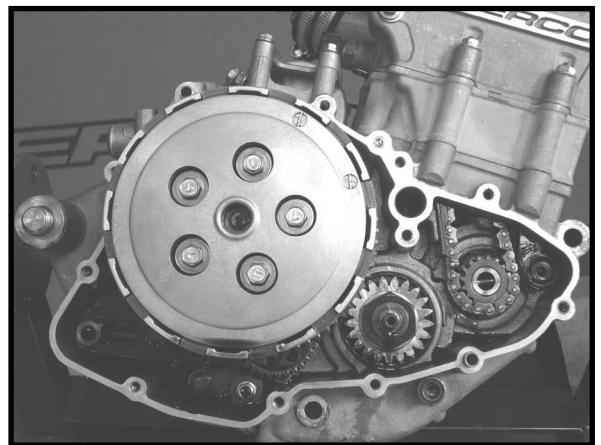
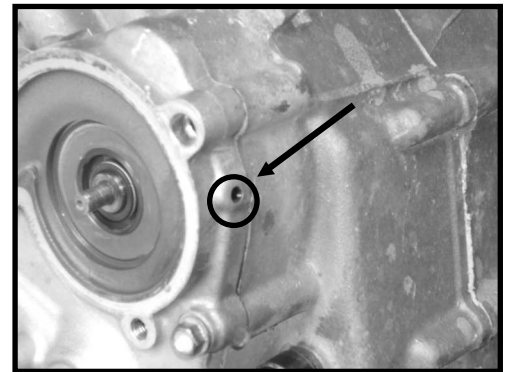
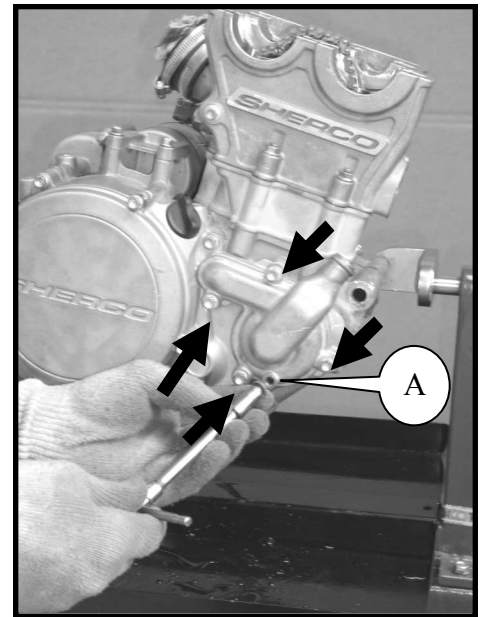



### Removing the clutch hub and the clutch basket:

- Drain the engine oil and the engine coolant.
- Remove the clutch housing. (see disassembling the right side paragraph)
- Remove the clutch. (see clutch removal paragraph)
- Remove the clutch release bearing assembly.
- Retain the clutch hub using tool 1814.
- Loosen the clutch hub nut.



**ATTENTION** Attention, make sure the special timing tool number 1819 is not installed, if it is, severe damage could occur to the crankshaft and crankcase.

- Remove the hub and the nut.
- Inspect the needle bearings and replace if necessary.
- Visually inspect the hub and the housing.

### Reassembling the clutch hub components:

- Install the thrust washer.
- Install the needle bearings.
- Install the clutch housing.
- Install the spacer washer.
- Install the clutch hub.
- Apply engine oil to the shaft threads and the fixing nut.
- Install the conical washer.
- Install the fixing nut.

**Torque the fixing nut to:  
80Nm.**

- Check for free rotation of the clutch hub.
- Reinstall the clutch release bearing assembly, the clutch and the clutch housing in the reverse order of their removal.

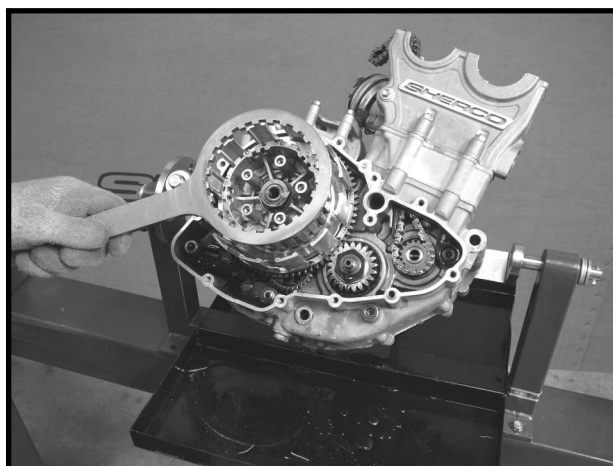
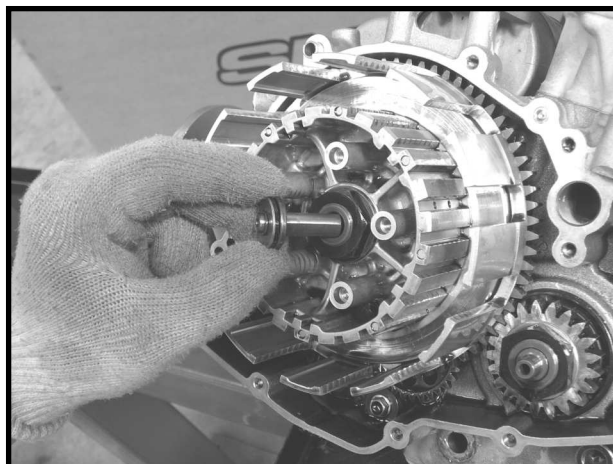

## Disassembling the left side

For additional details refer to the parts catalog 250i.

### Disassembling the ignition case:

- Drain the engine oil.
- Remove the 10 screws that retain the ignition case.
- Visually inspect the inner surfaces of the rotor [A] and the outer surfaces of the stator [B].
- Check the pulse generator (sensor)
- Replace if necessary.

### Replacing the stator and sensor system:

- Remove the two screws that retain the sensor [C] and the two screws that retain the stator [D].
- Install the new parts.
- Reinstall the screws using the proper torque.

**Torque the stator and sensor screws to: 8Nm.**

### Removing the rotor:

- Utilize the special rotor holding tool number 1815.
- Remove the rotor fixing nut.

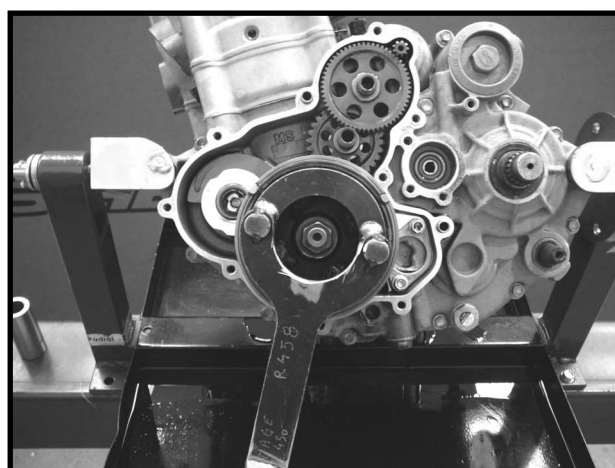
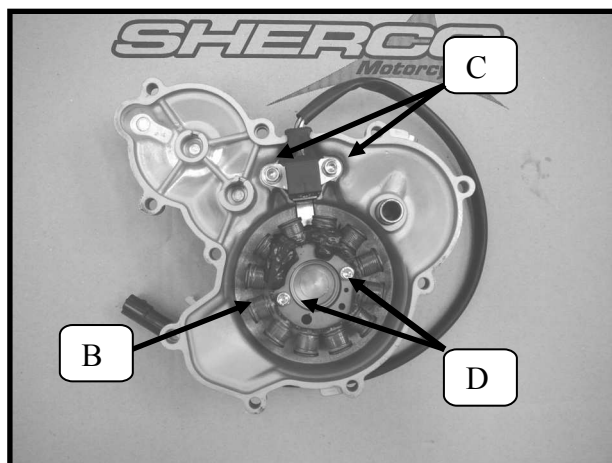
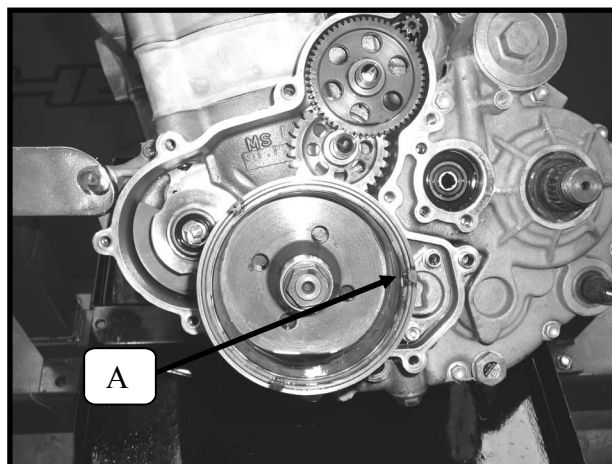

- Remove the flywheel using special tool number R462.
- Remove the two starter shafts along with the starter gears.
- Remove the oil centrifuge (anti blowby)



Attention the threads this screw are LH, do not turn the wrong direction.

- Remove the freewheel. (see photo)

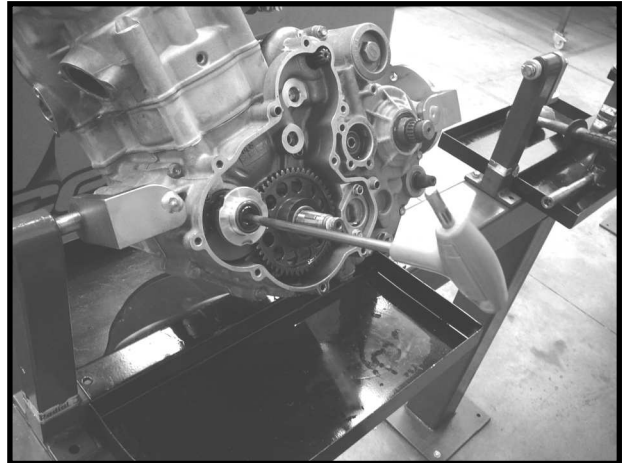
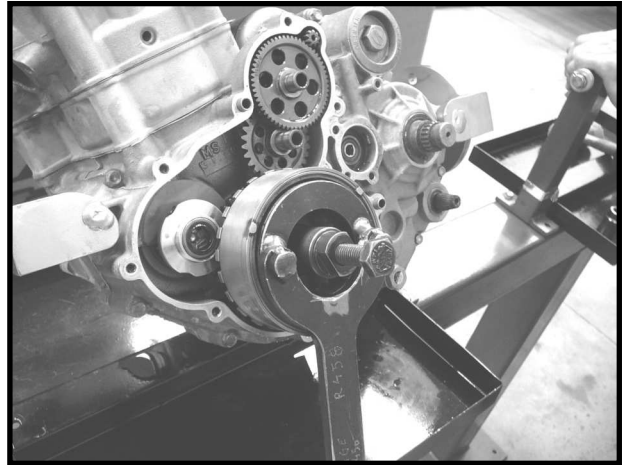

#### Inspect the freewheel and the needle bearings:

- Visually inspect the caged needle bearings.
- Replace if necessary.
- Inspect the condition of the freewheel.
- Replace if necessary.



If the freewheel must be replaced then the rest of the gears must be replaced and vice versa.

- Finally check the rollers on the freewheel.
- Replace if necessary.



If the freewheel must be replaced then the rest of the gears must be replaced and vice versa.

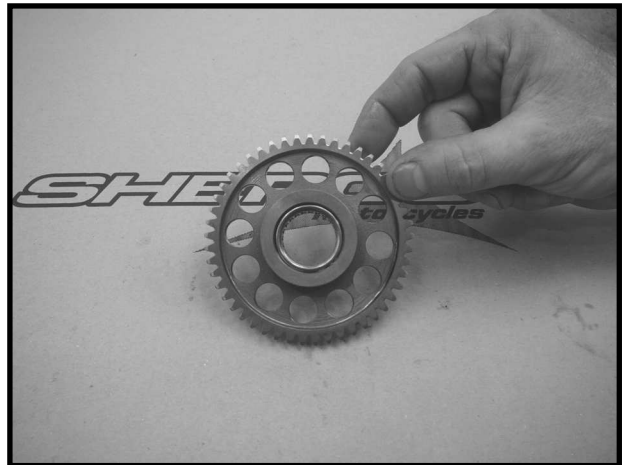

### Reassembling the ignition case:

- Apply grease to the caged needle bearing and reinstall it.
  - Reinstall the two starter shafts and their gears.
  - Visually inspect the oil seal on the oil centrifuge.
  - Use special tool number 1818 to install the oil centrifuge.
- Tighten the oil centrifuge fixing screw to the appropriate torque.



This screw thread is reversed, it is a LH thread.

- Screw and tighten the centrifuge.
- Torque the centrifuge fixing screw to:  
8 Nm.**
- Inspect the rotor key, change if necessary.
  - Install the rotor (turn the rotor counter clockwise to help facilitate the installation of the lighting rotor).
  - Apply proper tightening torque to the nut on the rotor.
  - Install the conical washer.
  - Using special tool number 1815 to hold the rotor tighten the fixing nut.

**Torque the fixing nut to:  
100 Nm.**

- Install the remaining shafts and gears.
- Install the two case locating pins.
- Install a new gasket.
- Install the ignition crankcase cover and tighten the 10 screws.

**Torque the ignition crankcase cover screws to:  
10 Nm.**

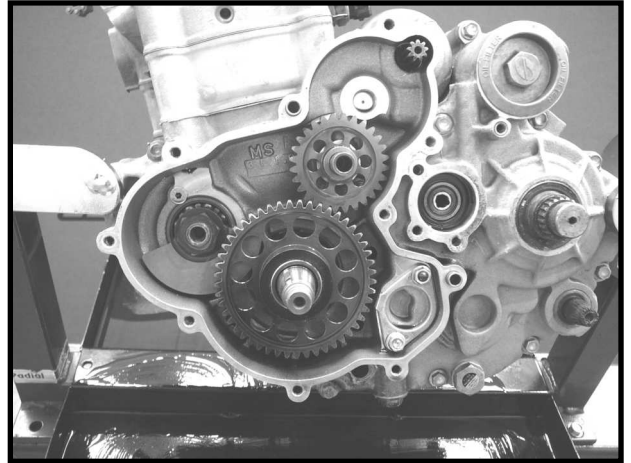

# Crankcase / Transmission / Central crankcases

## Disassembling the transmission and the crankshaft:

- Remove the engine from the frame (see the engine removal chapter).
- Remove the top end (see the top end chapter).
- Remove the ignition components (see the ignition chapter).
- Remove the clutch components (see the clutch chapter).
- Remove the cam drive chain (see the top end chapter).
- Remove the cam chain tensioner and guides.
- Block the transmission primary gear with special tool number 1817.
- Loosen the fixing nut for the counter balancer.
- Remove the counter balancer weight.
- Remove the freewheel / crankshaft spacer using a two armed gear puller. (see photo)
- Remove the engine oil pump cover.
- Block the transmission primary gear with special tool number 1817.
- Remove the transmission primary gear.
- Remove the clutch basket, the needle bearings and the thrust washer.
- Remove the primary transmission gears.
- Remove the oil pump drive gear.
- Remove the oil pump cover.
- Remove the oil pump rotor.
- Remove the oil pump shaft.
- Remove the gear selector shaft.
- Using special tool number 2073 block the gear selector drum and remove the gear selector index wheel screw...
- Remove the gear selector index wheel.
- Remove special tool number 2073.
- Remove the starter motor.
- Loosen and remove the 13 central crankcase screws.

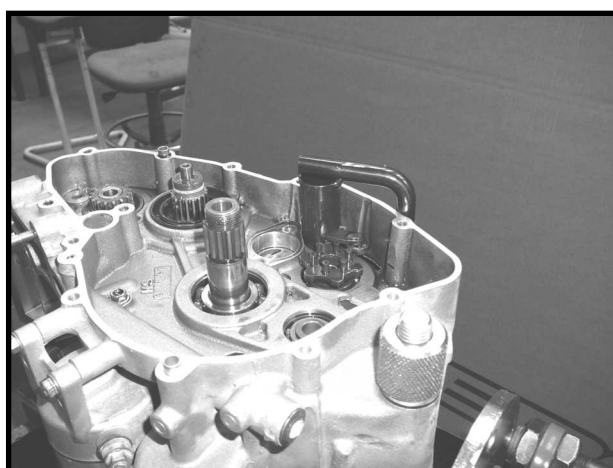
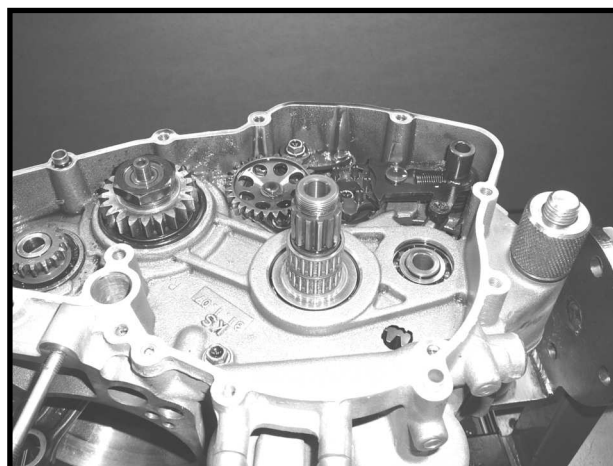
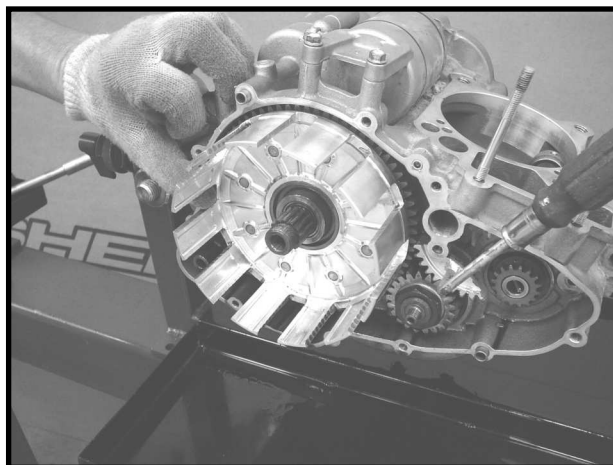

- Remove the Right side crankcase.
- Remove the crankshaft.
- Remove the counter balancer assembly.
- Remove the shifting fork shafts.
- Remove the gear selector drum.
- Remove the shift forks.
- Remove the remaining transmission components.



#### Checking the transmission components:

- Check the condition of all the gears. Inspect the engagement dogs [A], look at all of the gear teeth [B] and the fork shifting groove on each gear [C]. If any of the parts are damaged or badly worn they should be replaced.

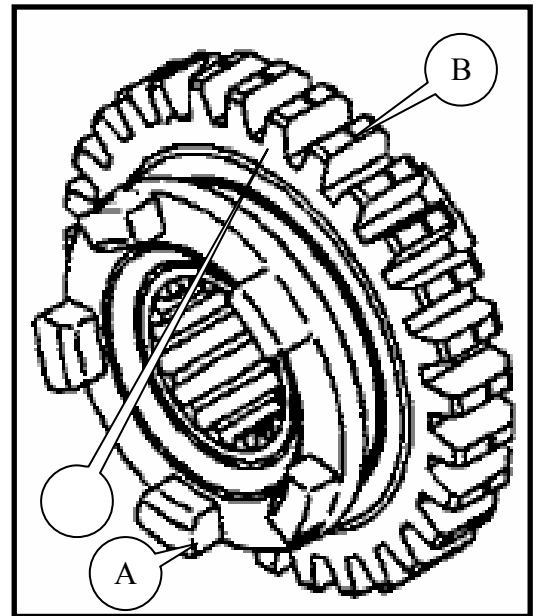

- Check the condition of all the shifting forks. Replace the shifting forks if necessary.
- Check the condition of the gear selector drum, make sure it is not deformed, damaged or badly worn. Replace the gear selector drum if necessary.

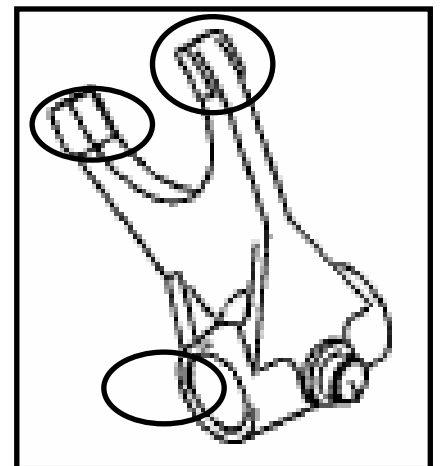

### Checking the crankshaft:

#### Radial play of the big end bearing:

- Place the crankshaft in a set of V blocks and install a dial indicator as shown [A].
- Push the rod [B] in the direction of the indicator and then push it in the opposite direction. The difference between these two readings is the radial play.

#### **Radial play of the big end bearing:**

**Standard: 0.015 mm – 0.020 mm**

**Tolerance limit: 0.06 mm**

If the radial play exceeds the tolerance limit the crankshaft must be replaced.

#### Lateral movement of the big end:

- Measure the lateral movement of the big end [A].

#### **Lateral movement of the big end:**

**Standard: 0.2 mm - 0.3mm**

**Tolerance limit: 0.55 mm**

If the lateral movement of the big end exceeds the tolerance the crankshaft must be replaced.

#### Checking the run out:

- Place the crankshaft in a lathe or suitable support, place dial indicators as shown.
- Turn the crankshaft and record the readings. The maximum difference between the readings is the crankshaft run out.

#### **Run out:**

**Standard: 0.02 mm maximum**

**Tolerance limit: 0.08 mm**

If the run out exceeds the tolerance, replace the crankshaft or straighten it so that it meets the tolerance.

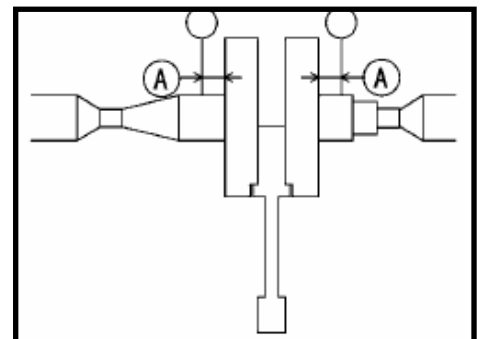
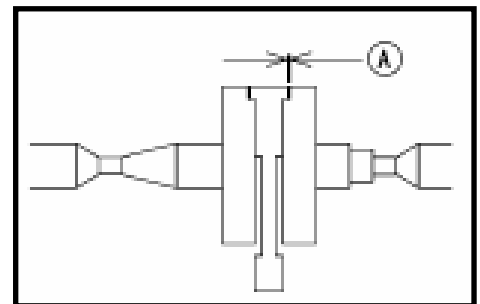
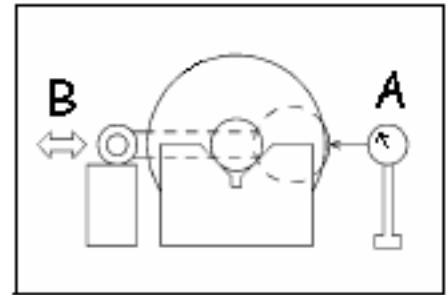

Checking the center crankcases:

- Inspect the general condition of the center crankcases for wear and cracks. Replace the center crankcase if necessary.
- Inspect the condition of all the bearings. Replace the bearings if necessary.
- Inspect the condition of the crankshaft bearings. Replace the crankshaft bearings if necessary.
- To remove the bearings, install tool number R464, heat the tool and the bearing.
- Remove the bearing.



The radial play in the roller bearings must be practically zero.





### Reassembling the central crankcase assembly:



During the rebuild, replace all seals (paper, seal, o-ring...).

- Install the crankshaft and counter balancer assembly in the left case, align the marks as shown.
- Install the transmission gear along with their corresponding shafts.

- Install a new roller on each shift fork.
- Install the shift forks in the transmission in their respective grooves.
- Install the gear selector drum.
- Place the shift fork rollers in their respective grooves in the drum.
- Install the shift fork shafts.



The center shift fork shaft is the smallest in diameter.



Do not forget to lubricate all of the rotating and sliding parts.

- Replace the two locating dowels in the case and install the washer on the transmission secondary shaft.

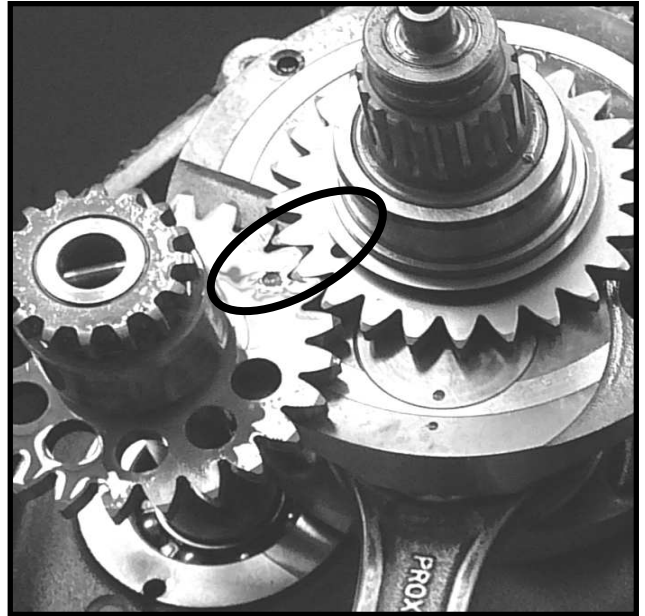

- On the right hand case make sure the breather jet is in place.
- Place the right case on the left case previously fabricated.
- Install the 13 screws that retain the two halves together.

**Torque the 13 center crankcase screws to: 10 Nm.**

- Install special tool number 2073 to keep the gear selector drum from rotating.
- Install the locating pin, the gear selector index wheel and the fixing screw.

**Torque the gear selector index wheel fixing screw to: 10 Nm.**

- Remove the special tool number 2073.
- Install the gear selector shaft.
- Install the oil pump shaft, the roll pin and the internal oil pump rotor.
- Install the oil pump cover and tighten the cover screws to the appropriate torque.

**Torque the oil pump cover screws to: 5 Nm.**

- Install the oil pump drive roll pin, the drive gear and the cir clip.
- Install the primary drive gear.
- On the transmission input shaft install the thrust washer, the needle bearings the clutch basket, the spacer washer, the clutch hub and the conical washer.
- Using an appropriate solvent clean the crankshaft threads and the input shaft threads.
- Install the fixing nuts on the crankshaft and the transmission input shaft.
- Apply the proper torque these fixing nuts.
- Install special tool number 1817 and torque the crankshaft fixing nut.

**Torque the crankshaft fixing nut to: 120 Nm.**

- With the special tool still installed, torque the transmission input fixing nut.

**Torque the transmission input fixing nut to: 80 Nm.**

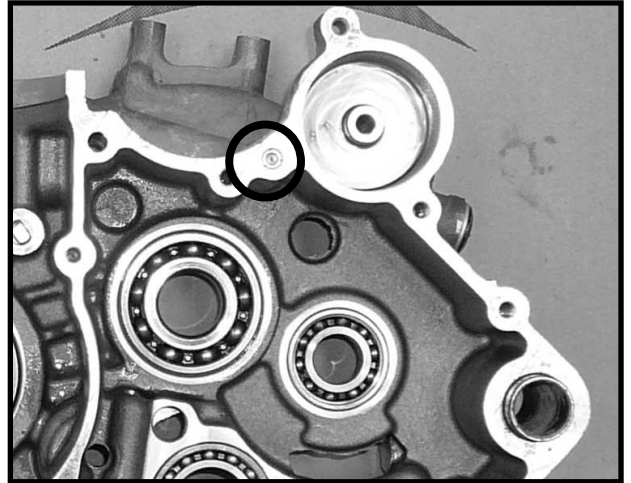

- Install the special tool that locks the engine at top dead center (ref 1819).

- Use tool 1817 to block the transmission and to tighten balancer nut.

**Torque of balancer nut 60 Nm + Loctite.**

- Install the oil pump drive roll pin, the internal rotor and fixing nut to the cover.

**Torque of the oil pump cover : 5 Nm.**

- Heat the crankshaft spacer ring (ref 1732) to approximately 70 degrees and install it on the crankshaft.

- Replace the freewheel assembly and the starter drive gear train (see the paragraph on disassembling the left side).

- Reinstall the starter.

- Reinstall the motor top end (see the paragraph on the top end).

- Install the cam drive chain (see the paragraph on top end).

- Install the clutch (see the paragraph on disassembling the right side).

- Install the clutch cover.

- Install the spark plug.

**Torque the spark plug to: 15 Nm.**



Apply brake net torque to all of the internal engine threads except the five clutch pressure plate fixing screws.

# Tightening torques

<b>Standard torque</b>		<b>Loctite</b>
M5	6 Nm	
M6	10 Nm	
M8	24 Nm	
M10	40 Nm	
<b>Frame tightening torques</b>		<b>Loctite</b>
Rear wheel axle nut	100 Nm	
Aluminium sub frame bolts	24 Nm	•
Front wheel axle nut	40 Nm	
Front fork /axle bolts / axle M6	15 Nm	
Brake pad bolt	8 Nm	•
Triple clamp bolts	17 Nm	
Motor screw	40 Nm	
Swing arm nut	100 Nm	
Cylinder head-frame screws	23 Nm	
<b>Motor tightening torques</b>		<b>Loctite</b>
Magnetic drain plug	22 Nm	
Drain plug with prefilter	22 Nm	
Oil filter cover	15 Nm	
Spark plug (with copper grease)	15 Nm	
Bolt for bleeding cooling system	6 Nm	

Motor tightening torques		Loctite
Ignition sensor screw	8 Nm	•
Bolt for bleeding cooling system	6 Nm	
Clutch slave cylinder screw	10 Nm	
Exhaust bolt	10Nm	
Cylinder head 1 <sup>st</sup> pass 2nd pass Hexagon nut M6	30 Nm 50 Nm 10 Nm	
Camshaft cap	10 Nm	
Chain tensioner screw (x2)	10 Nm	
Chain tensioner screw (x1)	10 Nm	
Timing control plug	8 Nm	
Chain guide screw	10 Nm	•
Clutch pression screw	10 Nm	
Water pump cover	11 Nm	
Rotor nut	100 Nm	•
Clutch nut	80 Nm	•
Oil breather wheel	8 Nm	
Ignition cover	10 Nm	
Crankcase screw	10 Nm	
Gear selector drum screw	10 Nm	
Oil pump cover	5 Nm	
Balancer nut	60 Nm	•

## SHERCO diagnostic tools

Your **Sherco 2.5i/4.5i/5.1i** is equipped with a Magneti Marelli fuel injection system. This system consists of a computer (ECU), an injector body, a fuel pump and various sensors (air pressure, air temperature, engine temperature and butterfly position sensor). To perform the diagnosis you must install the Sherco Vehicle Diagnostic Scan Tool Software (VDSTS). SHERCO reference R471. This software does not change the fuel injection map. This is only a diagnostic tool.

Num	Designation	Emplacement
1	Housing ECU+ atmospheric pressure sensor	Above the engine under the main frame. The sensor is built into the ECU box.
2	Butterfly position sensor (TPS)	On the right side of the injector body
3	Air temperature sensor	At the top and back of the air box
4	Water temperature sensor	At the rear of the cylinder head
5	Engine speed sensor	Upper Ignition crankcase

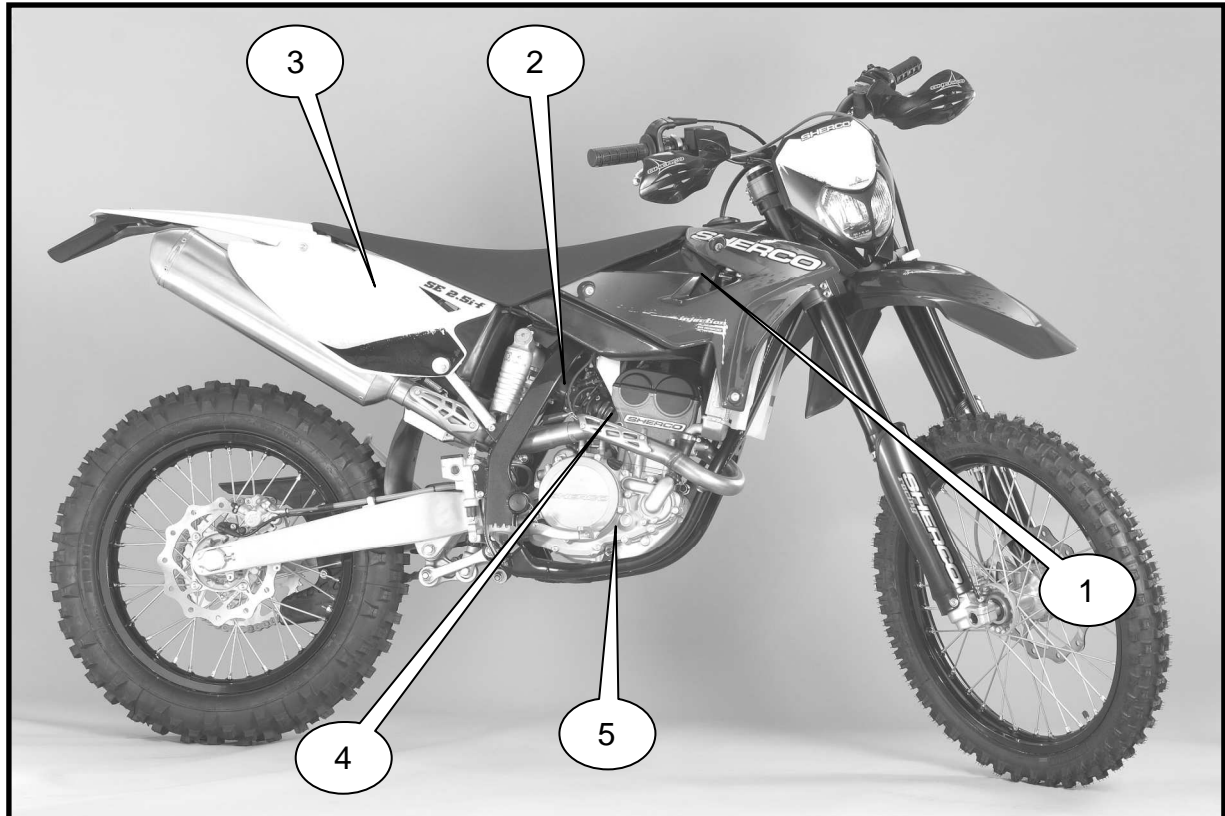

Contents of the diagnostic kit :



The diagnostic kit consists of an RS232 cable, battery cables and theVDSTS software.

Software installation

Insert the CD-ROM "Scan-Vehicle Diagnostic Software Tool" in your computer drive.

Run Setup setup.exe

Then follow the instructions on the screen.

Restart the computer.

Software presentation (the various interfaces) :

- ▶ **Communication menu** : Allows you to select the serial port of your computer which is the cable plugged into the vehicle
- ▶ **Instruments menu** : Allows you to view real-time engine speed, battery voltage, the butterfly opening, engine temperature, ambient temperature, atmospheric pressure, etc.
- ▶ **Graphs** : Reproduces real-time graphical data.
- ▶ **Bar graph menu** : Reproduces the data in bar graph format.
- ▶ **Function test menu** : Allows you to test various components of the injection system.
- ▶ **Configuration menu** : Allows you to check the synchronization the ECU / injector body and the CO.
- ▶ **System error menu** : Allows you to access the history of defects and flaws that have occurred.
- ▶ **System status menu** : Allows you to verify if all components of the system are functioning properly.

- ▶ **Connectcion** : Allows you to connect to the vehicle.
- ▶ **Disconnect** : Allows you to disconnect from the vehicle.
- ▶ **Ecu choice menu** : When you connect to the vehicle, the software automatically recognizes the type of ECU.

### Connecting the diagnostic kit wiring

Connect the serial cable RS232 to the serial port of your computer (laptop or desktop).  
Connect the power cable to the battery. Red connector on the + battery terminal, black connector to the – battery terminal.

Connect the male 3-way diagnostic connector to the motorcycle.

The diagnostic connector is located on the right of the steering column of the motorcycle.

Start the program by selecting the desired language.

Turn the motorcycle ignition on.



Connection problem ?



Check that:

-the battery voltage is sufficient (> 12V)

-the serial port of your computer corresponds to that of the software (change the port in the Communication menu).

### Performing diagnostic

The ECU backup memory detects any component defects. With the VDSTS you can view the current status and history. If there is a problem with your vehicle, the first thing to check is for any error message in the ECU memory:

- ▶ **Instrument screen menu**
- ▶ **E/S function errors**



To establish communications, use the "Connection menu" by clicking on the icon or selecting the menu command in the software.



When you start the motorcycle, if there is a default, a message will appear on the screen.

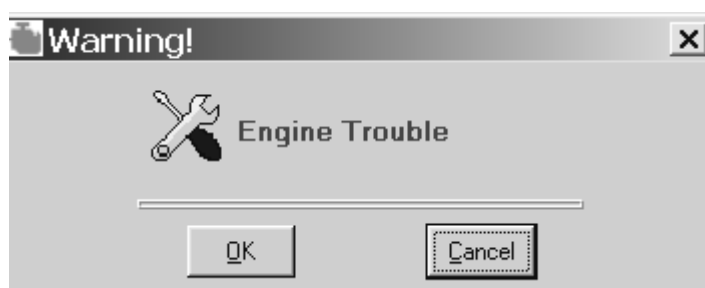

#### Errors code :

**Air temperature:** "O.C/High V." ou "S.C./Low V."  
**Engine Temperature:** "O.C/High V." ou "S.C./Low V."  
**Pressure:** "O.C/Low V." ou "S.C./High V."  
**Papillon Pos.:** "O.C/High V." ou "S.C./Low V."  
**Crank Pos.:** "Crank Pos Signal Error (LED rouge)"

**Battery Volt.:** "O.C/High V." ou "S.C./Low V."  
**Injecteur 1:** "O.C/Low V." ou "S.C./High V."  
**Bobine 1:** "O.C/Low V." ou "S.C./High V."  
**Tacho.:** "O.C/Low V." ou "S.C./High V."

#### Definition :

**O.C.:** Circuit Ouvert (Open Circuit)  
**S.C.:** Court circuit (Short Circuit)  
**High V.:** Haut Voltage (High Voltage)  
**Low V.:** Bas Voltage (Low Voltage)

The diagnostic operations are carried out in the menu Function, **Test / Active test** you can test various components of the injection system. When you test a component, a green light will appear.

You can test the following components: fuel injector, fuel pump, ignition coil voltage and the various engine sensors (the bike should be at its operating temperature and running for these tests).

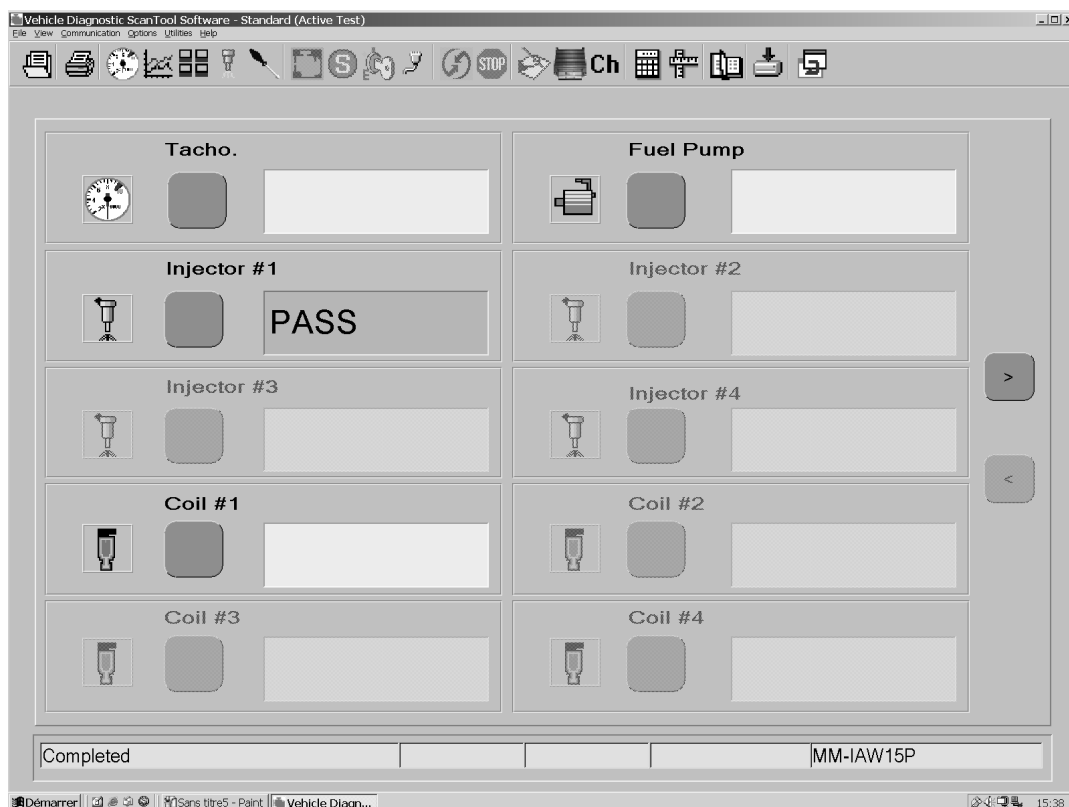

### Synchronizing the ECU / with the butterfly opening sensor (TPS)

A feature of the Magneti Marelli system is the requirement to synchronize the injector body with the ECU if any of these parts have been replaced. If you have to replace either the fuel injector body or the TPS, or both of these electronic components, you must do the following:



- ▶ Go to the Configuration Menu
- ▶ Click Erase errors. The green light is switched to OK.
- ▶ Click on TPS. The green light is switched OK. Otherwise, check the TPS sensor and ECU by returning to the Function Test Menu.

**Value of the butterfly angle position should be: 2.7 <3.1 <3.5**  
 Check that the painting has not accidentally removed from the butterfly stop screw. Never touch the butterfly stop screw.

The bike must be in perfect working condition (valves adjusted properly, fresh air filter, etc.). Check that air by-pass air screw at the injector body is not unscrewed over two TURNS out (factory value: 1 round).



Make this adjustment with the engine running.

1- For this operation you must have a lambda probe and a gas analyzer.

- Run the engine until it reaches 80 °C.
- Connect the CO detector
- Perform the test in real conditions (saddle and air filter installed)
- In the **Configuration menu**, set the CO at 5%

**Do not exceed the range of -15 to +15. If you must get out of this range, there is a problem (injector, TPS sensor, etc.).**

2 – If you do not have a lambda probe and gas analyzer.

If your perfectly tuned bike has an unstable idle you can set it using the Trimmer function.

**Do not exceed the range of -15 to +15. If you must get out of this range, there is a problem (injector, TPS sensor, etc.).**

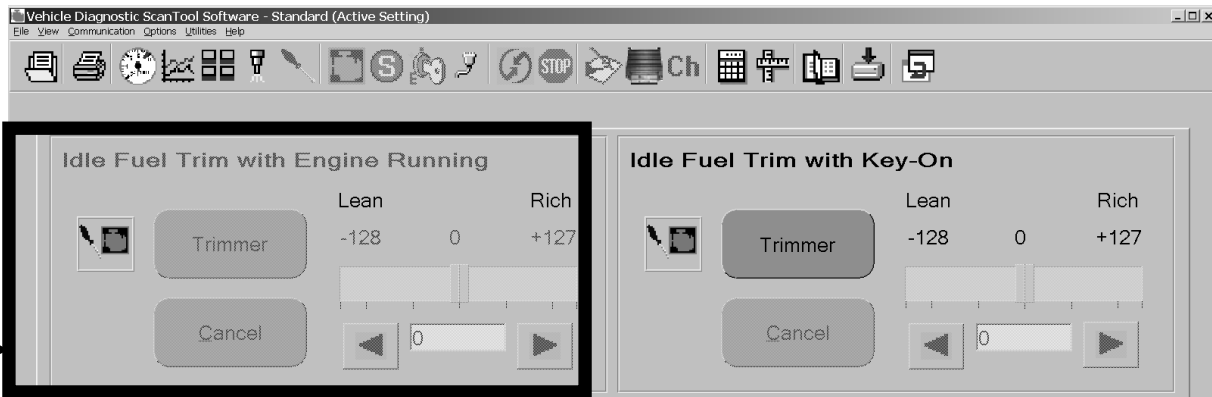

**Idle speed : 2.5i : 2200 +/-100tr/min  
4.5/5.1i : 1800 +/-100tr/min**

Electrical installation checkingStatic values (engine off)

**Tension battery : > 12.5V**  
**Stator resistance : 1.5/1.6 Ohms**  
**Pick up sensor : 500 Ohms**

Check there is no continuity between stator and the ground of the motorcycle

RegulatorDynamic values

**Alternative 200V alternative caliber)**  
**Low rpm: 22V +-2V**  
**A 6000 rpm : 77V+-3V**

**Continue**

**Regulator pins out (Caliber 20V continue)**  
**A 4000 tr/min : 14.6V + Red/white, - Green**

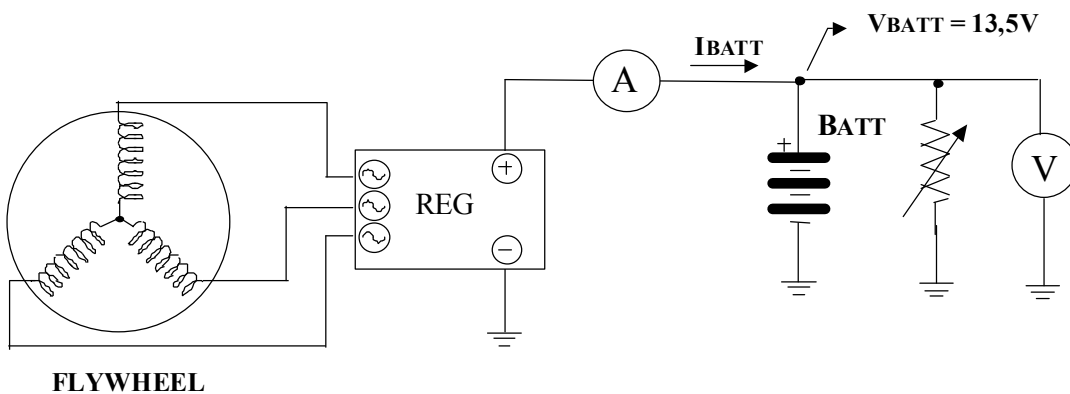
Battery recharge current

Battery voltage const = 13.5V

Tolérance on typical values = -5% / +10%

r.p.m.	Ampere d.c.
1000	5,0
1200	8,5
1500	11,6
2000	13,8
2500	15,0
3000	15,6
4000	16,2
5000	16,6
6000	16,8

## Cable diagram (Injection / light)

### Injection beam

#### ECU connections :

N° PIN	Fonction
1	5 volts
2	NC
3	RPM (information)
4	Water temperaturel
5	Ventilator
6	NC
7	RPM sensor
8	NC
9	Diagnostic connector
10	Dignostique connector
11	TPS sensor
12	RPM sensor
13	Injector
14	NC
15	NC
16	GND for double ignition mapping
17	+V_BATT +12v
18	Water temperature
19	Fuel relay
20	Ignition spark plug
21	NC
22	Sensor GND
23	GND Power
24	NC
25	N C
26	+ After Key



Light beamDashbord connection :

- Dashbord reference 0365



N°PIN	Fonction
1	NC
2	Left indicator
3	Beam
4	NC
5	NC
6	NC
7	Vcc_Hall
8	RPM
9	V_BATT
10	Sens_In
11	NC
12	High beam
13	Right indicator
14	GND sensor
15	NC
16	NC
17	P15_Key
18	GND

- Dashboard reference 1723

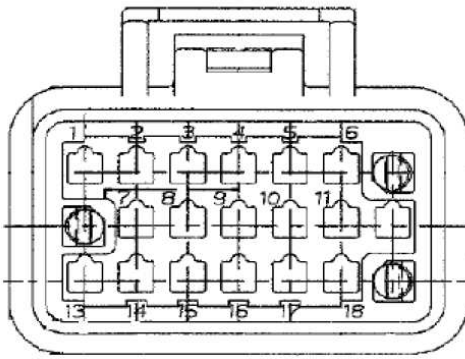

Dashbord connector ref  
1723 Rear view

N°PIN	Fonction
1	V_BATT (+batt 12v)
2	Fuel
3	Rpm
4	+ Après contact
5	High beam
6	VCC_Hall
7	NC
8	Sens_In
9	Neutral
10	Oil
11	GND
12	NC
13	Right indicator
14	Left indicator
15	Reserved
16	GND
17	GND
18	GND



Cable diagram :

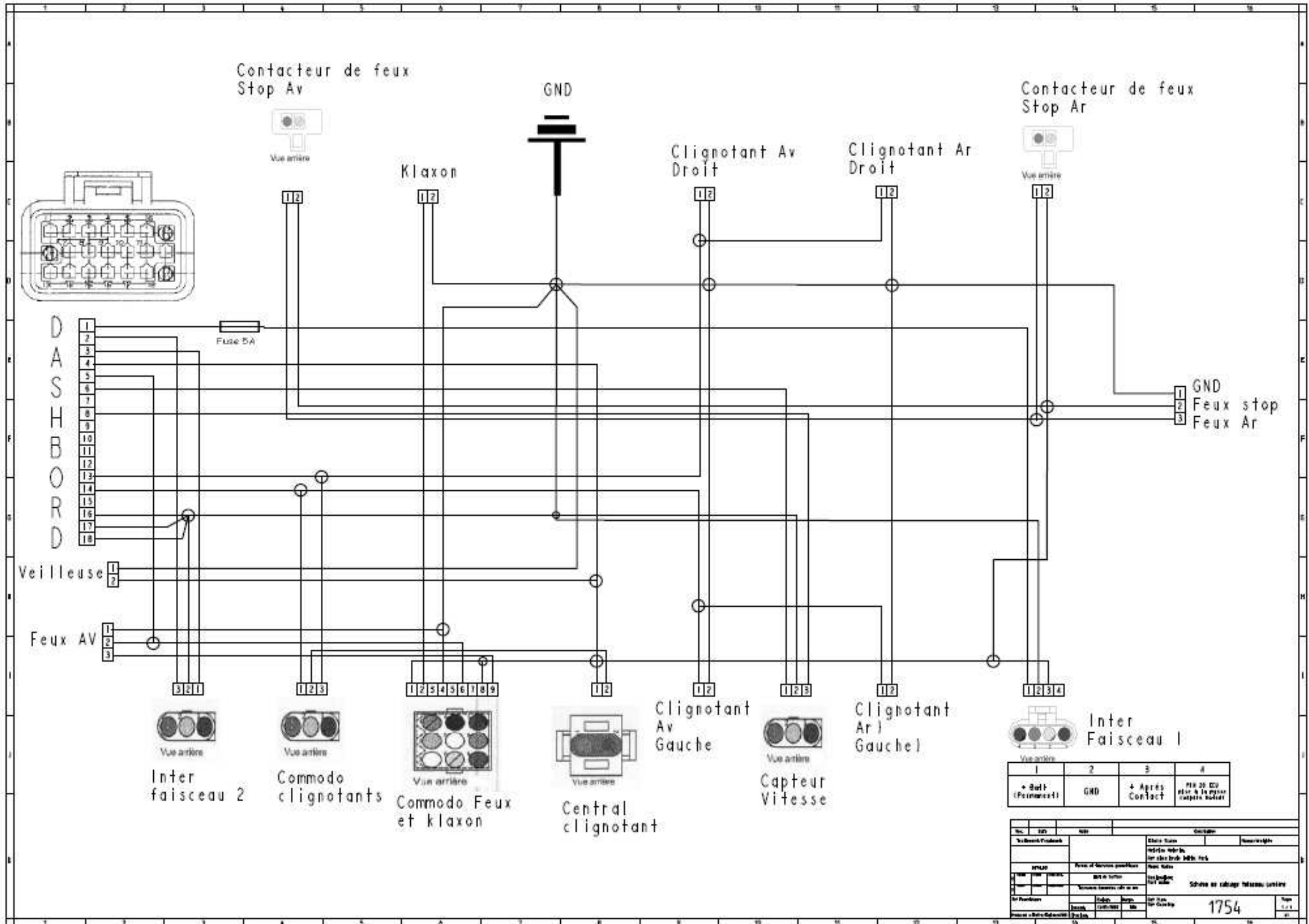

1	2	3	4
+ Batt (Pointmass)	GND	+ Après Contact	Pin 20 ECU plus à la place capteur vitesse

Titre	Objet	Version	Échelle
1754 Schéma de câblage Niveau 1/1 1754			