

250 SEF RACING
250 SEF FACTORY
300 SEF RACING
300 SEF FACTORY



Table of contents

FORWARD	2
TOOL LIST	3
TECHNICAL SPECIFICATION	4
ENGINE	4
FRAME	5
STANDARD ADJUSTMENT	6
FORK	6
SHOCK ABSORBER	7
OPERATIONS REQUIRING DEMOUNTING OR NOT	
ENGINE	8
REMOVING / REINSTALLING THE ENGINE	9
REMOVING THE ENGINE	9
REINSTALLING THE ENGINE	9
ENGINE	10
REMOVING THE CYLINDER HEAD	10
») Preparation.....	10
») Removing the cam chain tensioner.....	10
») Removing the camshafts.....	11
») Removing head cylinder.....	11
INDIVIDUAL PARTS INSPECTION	12
ENGINE TOP END CONTROLS	12
») Inspection of the cylinder for wear.....	12
») Piston wear.....	13
») Cylinder head inspection.....	15
») Visually inspect the timing chain for damage ..	15
») Valve – Guide clearance.....	15
REASSEMBLING THE TOP END OF THE ENGINE 16	
») Reassemble the piston.....	16
») Reassemble the cylinder head.....	17
») Valve timing.....	18
») Valve clearance.....	20
») Replacing the timing chain.....	20
DISASSEMBLING COVER	21
DISASSEMBLING THE RIGHT SIDE	21
») Clutch dismantling.....	21
») Inspection of the clutch.....	21
») Check the clutch spring length.....	21
») Disassembling and inspecting the water pump.....	22
») Reassembling the clutch hub and the clutch basket.....	23
») Reassembling the clutch hub components.....	23
DISASSEMBLING THE LEFT SIDE	24
») Disassembling the ignition case.....	24
») Replacing the stator and sensor system.....	24
») Removing the rotor.....	25
») Inspect the freewheel and the needle bearings.....	25
») Reassembling the ignition case.....	26
DISASSEMBLING CRANKCASES	27
CRANKSHAFT - TRANSMISSION - CENTRAL	
CRANKCASES	27
») Disassembling the transmission and the crankshaft.....	27
») Checking the transmission components.....	28
») Checking the crankshaft.....	29
») Checking the crankcase.....	30

») Reassembling the central crankcase assembly.....	30
TIGHTENING TORQUES	34
INJECTOR BODY	36
<i>Clean injector body</i>	36
») Material.....	36
») Put down the injector body.....	36
») Clean of injector body.....	38
») Replace the injector body.....	38
ELECTRICAL INSTALLATION CHECKING	39
») 1- Fan control.....	39
») 2- CDI.....	39
») 3- Fuel pump control.....	39
») 4- Fall sensor control.....	40
») 5- Checking the voltage regulator.....	40
») 6- Battery control.....	40
») 7- Map sensor control.....	41
») 8- TPS sensor control.....	41
») 9- Stepper motor control.....	42
») 10- Injector control.....	42
») 11- Starter control.....	42
») 12- Checking the alternator.....	43
») 13- Hall sensor control (Crankshaft).....	43
») 14- Water sensor control.....	44
») 15- Ignition coil control.....	44
WIRING HARNESS	45
») Homologated light wire harness (8145).....	45
») Racing light wire harness (6845).....	46
») Main wire harness (7314).....	47
») Fan wire harness (3577).....	48
SYNERJECT INJECTION SYSTEM INSTRUCTION	
MANUAL	49
SYNERJECT INJECTION SYSTEM PRESENTATION 49	
1.1- Injection system.....	49
1.2- Description Exxodiag diagnostic Tools référence 4967.....	50
1.3- Diagnostic tool kit contents.....	50
1.4- Installation of the diagnostic tool.....	51
2.1- Connection with Keyless system.....	55
2.2- Software settings : configuration menu.....	57
2.3- Update menu and synchronization.....	58
2.4- Using the software.....	60
C- Reading the default codes.....	62
D- Erasing default codes.....	63
E- Test the actuators.....	65
F- Updating the computer.....	67
G- Screen printing function.....	69

FORWARD

This manual is designed primarily for skilled mechanics working in a properly equipped workshop. The execution of the operations in this manual requires a strong mechanical knowledge and specific SHERCO tools designed for the 250 SEF and 300 SEF engine.

This workshop manual is a supplement to the SHERCO 250 SEF and 300 SEF owner's manual.

TOOL LIST

TOOL 250/300 4T

Fuel pressure
tool 8691

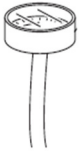

Clutch tool 1814

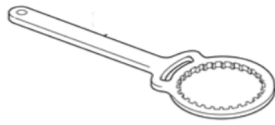

Support piston tool
1818



Owner manual
8700



Ring extractor R464

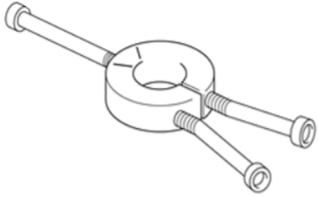

Pinion clutch
shaft tool 1817

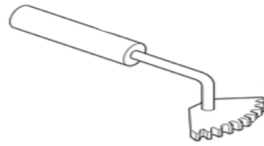

Tool ignition
4753

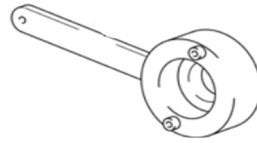

Container / Support
Engine Tool R481/R455

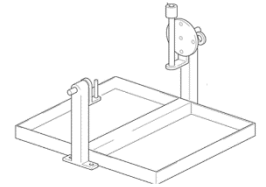

Flying
extractor R462



Top dead point
1819



Diagnostic
Injection tool 8561



Tools 0726



FACTORY

Inner tube
clamp 7670



Top cap
wrench 7666



Oil seal
insert 7668



Seal Hammer
7669



Piston rod
holder 7667



Tool fit up
5028



7671

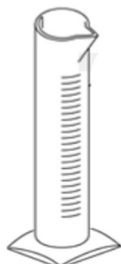

SUSPENSION

Clamp Jaw
5031

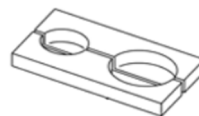

Tool xplor cap
7189

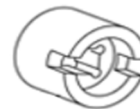

RACING

Tool fit sealing
5029



TECHNICAL SPECIFICATION

ENGINE

	250 SEF	300 SEF
Type	Liquid cooled single cylinder 4 strokes engine	
Displacement	249.4 CC	303.7 CC
Bore / Stroke	78/52,2mm	84 / 54.8mm
Compression ratio	13 :1	12.4:1
Fuel	Without lead 95 or 98	
Valve timing	4 valves, DOHC driven by tooth type chain	
Admission valve diameter	31mm	31mm
Exhaust admission valve	26mm	
Thickness admission valve	0.15-0.2mm	
Thickness exhaust valve	0.2-0.25mm	
Crankshaft bearing	2 roller bearing	
Piston	Aluminium forge	
Lubrication	Lubrication under pressure with 2 trochoidal pumps	
Motor oil	1 liter SAE 5w40	
Primary reduction ratio	21 :70	
GEAR BOX :	6 speed	
1 st	14 : 33	
2 nd	17 : 30	
3 nd	19 : 28	
4 nd	21 : 26	
5 nd	23 : 24	
6 nd	25 : 22	
Final transmission	13 X 49	13 X 48
Clutch	Multi-disk in oil bath. Hydraulic command	
Ignition system / Battery	Electric 12V 4Ah / LTZ5S Lithium 12V 2Ah	
Electronic injection	Synerject	

TECHNICAL SPECIFICATION

FRAME

Frame	Semi-perimeter CrMo steel with aluminum subframe
Fork	KAYABA USD Ø48mm Closed cartridge(FACTORY) WP XPLOR USD Ø48mm (RACING)
Rear suspension	KAYABA suspension with separate cylinder WP suspension with separate cylinder, Aluminium swing arm
Travel Front/Rear	FACTORY 330/330mm RACING 300/330mm
Front brake	disque Ø 260mm
Rear brake	disque Ø 220mm
Brake disc	limit : 2.7mm front et 3.6mm rear
Front tire	90/90-21"
Rear tyre	140/80-18"
Pressure front / Rear	0.9 bar
Fuel tank capacity	9.7l with 1 liter of reserve
Angle of the steering column	27.3°
Wheel base	1480mm
Weight (without fuel)	102 kg



STANDARD ADJUSTMENT

FORK

Original settings – Fork KAYABA USD Ø48 mm

Compression	Comfort	20 clicks back
	Standard	12 clicks back
	Sport	8 clicks back
Rebound	Comfort	18 clicks back
	Standard	12 clicks back
	Sport	10 clicks back
Spring	Rider weight : 65-75 kg	4.0N/mm
	Rider weight : 75-85 kg	4.2N/m
	Rider weight : 85-95	4.4N/m
Fork oil	01M	345 CC

Original settings – Fork WP XPLOR suspension USD Ø48mm

Compression	Comfort	18 clicks back
	Standard	15 clicks back
	Sport	12 clicks back
Rebound	Comfort	18 clicks back
	Standard	15 clicks back
	Sport	12 clicks back
Preload	Comfort	+0 tours
	Standard	+0 tours
	Sport	+6 tours
Spring stiffness	Rider weight : 65 - 75 kg	4.2N/mm
	Rider weight : 75 - 85 kg	4.4N/mm (original)
	Rider weight : 85 - 95 kg	4.6N/mm
Type of oil		SAE 4
Spring length with preload spacer		474 mm
Quantity of oil		606ml
Oil level measurement (fork compressed and spring removed) from the top of the fork tube		100mm (min30-max 120 mm)

STANDARD ADJUSTMENT

SHOCK ABSORBER

Racing Settings – KAYABA shock absorber

Low-speed compression	Comfort	20 clicks back
	Standard	14 clicks back
	Sport	12 clicks back
High-speed compression	Comfort	2,5 turns back
	Standard	1.5 turns back
	Sport	1 turn back
Rebound	Comfort	15 clicks back
	Standard	13 clicks back
	Sport	11 clicks back
Spring stiffness	Rider weight : 65-75 kg	46N/mm
	Rider weight : 75-85 kg	48N/mm (original)
	Rider weight : 85-95 kg	50N/mm
Type of oil		K2C

Racing Settings – WP suspension shock absorber

Low-speed compression	Comfort	17 clicks back
	Standard	12 clicks back
	Sport	9 clicks back
High-speed compression	Comfort	2 turns back
	Standard	1.5 turns back
	Sport	1 turn back
Rebound	Comfort	16 clicks back
	Standard	14 clicks back
	Sport	12 clicks back
Spring stiffness	Rider weight : 65-75 kg	51N/mm
	Rider weight : 75-85 kg	54N/mm (original)
	Rider weight : 85-95 kg	57N/mm



OPERATIONS REQUIRING DEMOUNTING OR NOT ENGINE

	REMOVING ENGINE	NOT DEMOUNTING ENGINE
Crankshaft	•	
Gear box	•	
Crankshaft bearing	•	
Gear Box bearing	•	
Piston		•
Cylinder		•
Cylinder head		•
Valve timing		•
Ignition		•
Pinion of ignition system		•
Freewheel		•
Clutch		•
Water pump		•
Oil pump		•
Gear selection		•

REMOVING / REINSTALLING THE ENGINE

REMOVING THE ENGINE

WARNING

*To remove the engine, you must remove the swing arm axle, the swing arm and the rear wheel.
To keep the bike from falling, remember to support the chassis with an appropriate jack.*

- Drain (refer to the owner's manual)
 - the engine oil
 - the engine coolant
- Remove the seat.
- Disconnect the battery.
- Remove the fuel tank and its covers.
- Disconnect all the electrical wiring connectors from the engine.
(Starter, TPS sensor, water temperature sensor, coil, fuel injector)
- Remove the exhaust.
- Remove the ignition coil.
- Remove the fuel injector body.
- Remove the chain.
- Remove the chain guard.
- Remove the clutch actuating cylinder.

WARNING

When the clutch actuating cylinder is removed the piston is loose. Hold the piston in place using a plastic strap.

- Remove all of the water hoses connected to the motor.
- Remove the left radiator.
- Loosen all of the engine bolts [A].
- Loosen the swing arm bolt.
- Remove the brackets that attach the cylinder head to the chassis.
- Remove the motor mounting bolts.
- Remove the swing arm bolt.
- Remove the motor.

REINSTALLING THE ENGINE

The motor should be reinstalled in the frame in the reverse order of how it was removed. The following torque values should be utilized.

Tightening torques:

Motor mounting bolts: 60Nm

Swing arm axle nut: 100 Nm

Clutch receiver screws: 10 Nm

Cylinder head bracket bolts: 23Nm

Exhaust mounting bolts:



For additional details refer to the parts catalog 250 SEF _ 300 SEF

REMOVING THE CYLINDER HEAD

- Remove the spark plug.
- Remove the valve cover.
- Remove the three valve cover screws.

WARNING

These three screws are equipped with o-rings. Ref: 0900

» Preparation

- Place the engine on the R455 engine support tool.
- Drain the engine oil (see user manual).
- Make sure to be in a clean environment before starting the dismantling of the engine.
- Remove the ignition cover plug [A]
- Remove the timing control plug [A]
- Turn the engine counterclockwise in order to align the timing marks on the crankshaft with the marks on the timing gear. Install the special tool that locks the engine at Top Dead Center

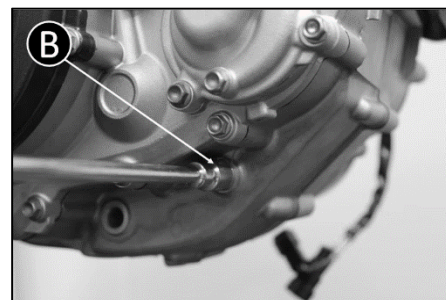
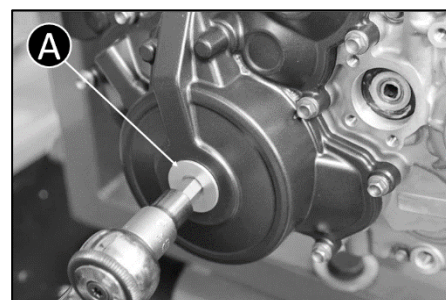

» Removing the cam chain tensioner

- Remove the screws from the cam chain tensioner as shown in the photo.
- Remove the cam chain tensioner.
- Remove the spark plug well

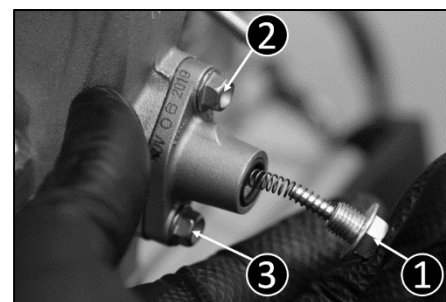

› Removing the camshafts

- Unscrew the eight screws from the shaft bearing cap cam following the order shown in the picture.
- Remove the bearing cap.

- Remove the exhaust camshaft retaining clip.
- Remove the exhaust camshaft.
- Remove the intake camshaft retaining clip.
- Remove the intake camshaft.

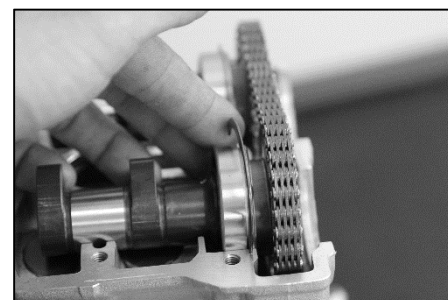
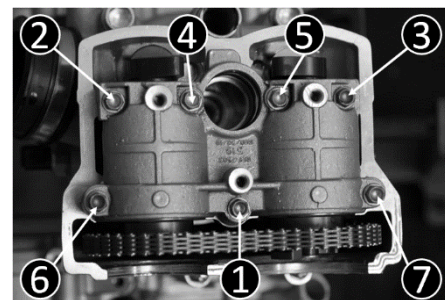

› Removing head cylinder

- Remove the two nuts M6 and the washer.

- Remove the cylinder head bolts (Be sure to loosen them in the correct direction).

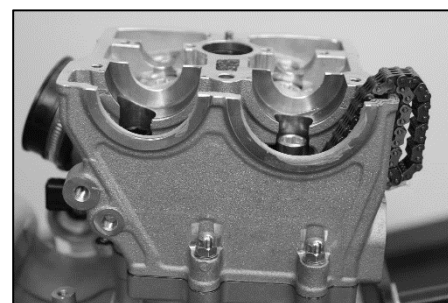

WARNING
Black bolt N°1 on the picture is longer, 3 bolts are identical.

- Remove the cylinder head.
- Remove the head gasket and the cylinder

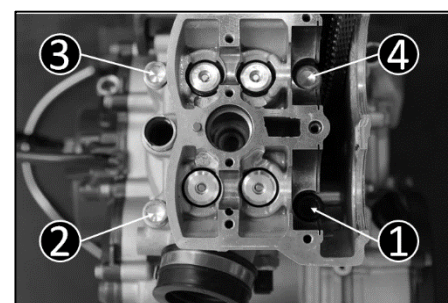

ENGINE TOP END CONTROLS

» Inspection of the cylinder for wear

Measure the inside diameter of the cylinder when it is cold.

Inspect the inside of the cylinder for any scratches or other evidence of abnormal wear. If the cylinder is badly damaged or worn it should be replaced.

Since the cylinder does not wear in a uniform manner measure in from side to side and up and down as shown.

If the inside measurement of the cylinder exceeds the tolerance limit it must be replaced.

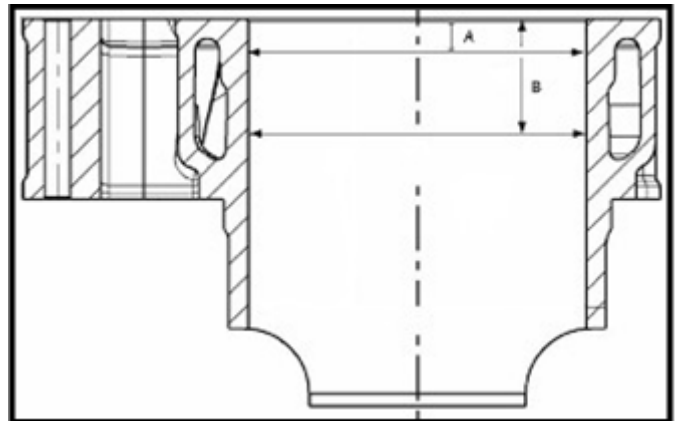

(A)=10 mm

(B)=25 mm

Standard 250 SEF

Cylinder diameter (A): $77.982 \pm 0.008 \text{ mm}$

Cylinder diameter (B): $77.982 \pm 0.015 \text{ mm}$

Taper limit: 0.05mm

Out of round limit: 0.05mm

Standard 300 SEF

Cylinder diameter (A): $83.982 \pm 0.01 \text{ mm}$

Cylinder diameter (B): $83.982 \pm 83.995 \text{ mm}$

Taper limit: 0.05mm

Out of round limit: 0.05mm

Piston / Cylinder clearance

To determine the piston / cylinder clearance as accurately as possible it is sufficient to measure the piston and the cylinder, and then calculate the difference between the two values. Measure the diameters as shown.

Piston / Cylinder clearances

Standard 0.03 – 0.05 mm

Limit 0.10 mm

›) Piston wear

- Using a micrometer measure the outside diameter of the piston [A] 10mm [B] above the bottom of the piston and at right angles to the axis of the piston.

If the outer diameter of the piston is below the tolerance it must be replaced.

Piston 250 SEF= 77.9400 ± 0.005 mm

Piston 300 SEF= 83.950 ± 0.005 mm

Ring groove / Piston ring

- Using a feeler gauge measure the clearance between the piston ring and the ring groove.
- Check in several places to determine the actual clearance if the clearance is greater than the maximum, replace the piston ring and if necessary the piston.

Ring groove / piston ring Standard

Compression ring: 0.030-0.065 mm

Limit: 0.13 mm

Oil ring: 0.020-0.055 mm

Limit: 0.13 mm

Ring end gap

- **Compression ring:** 0.3-0.4 Limit 0.7 mm
- **Oil ring:** 0.3-0.5 mm

Inspect the connecting rod, the piston pin and the piston for wear

- Visually inspect the circlips in place.
If they appear worn or distorted replace them. If the hole for the circlips appears worn replace the piston.
- Measure the piston pin with a micrometer. If at any place on the pin the diameter is below the limit replace the piston pin.
Measure the diameter of the piston pin holes in the piston and the hole in the connecting rod. If the one or more holes in the piston are incorrect replace the piston. If the diameter of the hole in the connecting rod is incorrect, replace the connecting rod

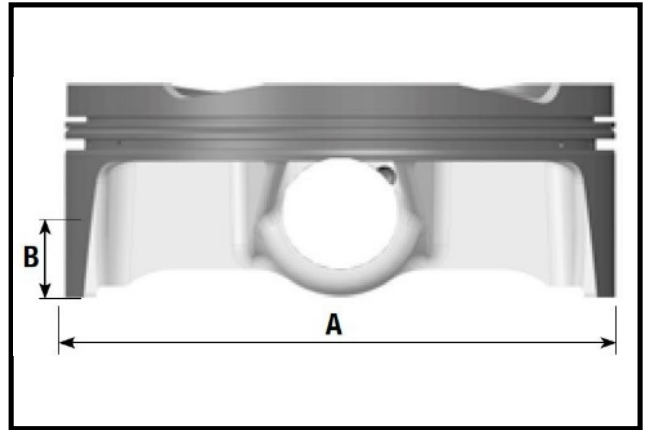

Piston pin diameter

15.997-16.000 mm

Piston pin hole diameter in the piston

16.004-16.009 mm

Connecting rod hole diameter

16.000-16.011 mm



INDIVIDUAL PARTS INSPECTION

Check the camshafts for wear

- Remove the camshafts.
- Measure the heights [A] of the camshaft lobes with a micrometer.
If the cams are worn beyond the limits, replace the cams.

Camshaft height limit 250

Exhaust: 32.10 mm

Intake: 32.40 mm

Camshaft height limit 300

Exhaust: 32,10 mm

Intake: 32.40 mm

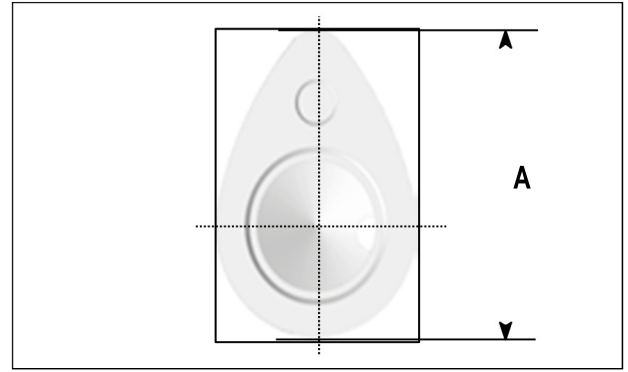

Checking the camshafts and camshaft journals for wear

- Measure the clearance between the camshaft and the camshaft journals using plastigage [A].
- Lubricate the fixing bolts with engine oil and tighten to the proper torque.

Tightening torque

Camshaft journal mounting bolts: 10 Nm

If any of the measurements are over the limit, then measure the diameter of each journal.

Camshaft / journal clearance Standard:

0.020 – 0.062 mm

Limit: 0.15 mm

If the diameter of the journal is below the limit replace the camshaft and measure again.

Camshaft journal diameter Standard:

23.05 – 23.25 mm

Limit 23.02 mm

If the clearance is outside of the tolerance limits, replace the entire cylinder head

Eccentricity of the camshaft

- Measure the camshaft runout.
If it is out of tolerance, replace the camshaft.
Runout : Less than 0.03

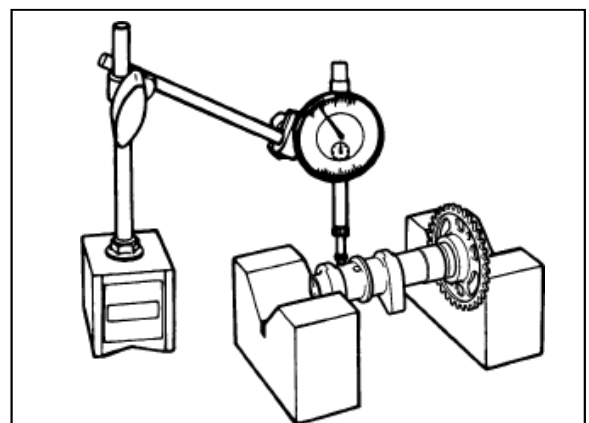
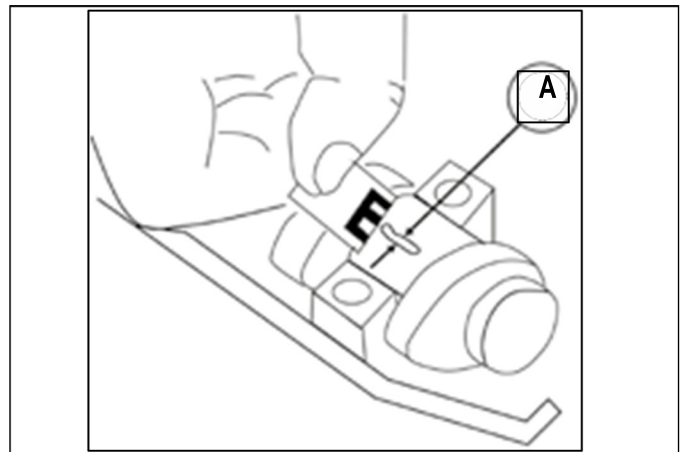

INDIVIDUAL PARTS INSPECTION

›) Cylinder head inspection

Inspect the cylinder head for flatness

- Place the cylinder head on the workbench.
- Using a precision straight edge [A] and a feeler gauge check the head for warpage; check in several places as shown in the photo.
If the warpage is above the limit, repair if possible. If the damage is severe replace the head.

Cylinder head warpage:
Limit = 0.05 mm

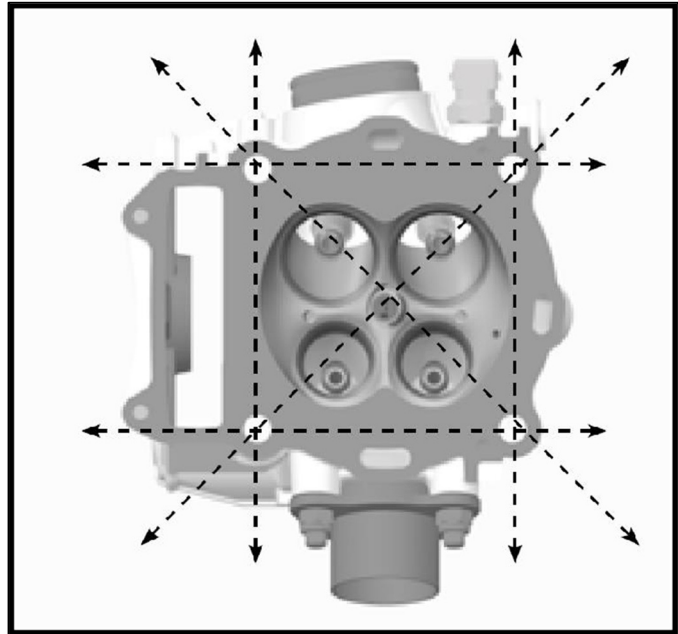

›) Visually inspect the timing chain for damage

- Clean all parts.
- Visually inspect the drive chain : check for any hard spot, resistance, or wear. If any, it must be changed.
- Visually inspect the distribution drive pinion. Change if necessary.
- Visually inspect distributions guide plates: change them if necessary.
- Visually inspect the pinion (1) ; replace if necessary.
- Check that the needle bearings fit tight when the pinion (1) is mounted on its axis.

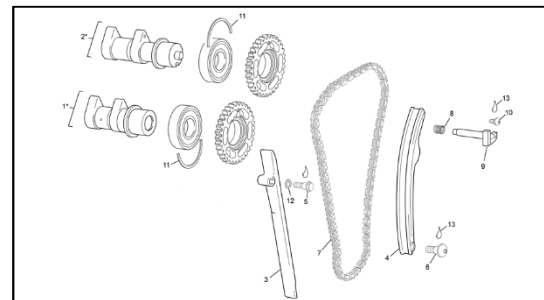

›) Valve – Guide clearance

Intake :

Mini clearance : 0.02 mm
Maxi clearance : 0.045 mm

Escape :

Mini clearance : 0.04 mm
Maxi clearance : 0.065 mm



REASSEMBLING THE TOP END OF THE ENGINE

» Reassemble the piston

- Install the piston rings on the piston with the end gaps as shown in the photo, the compression ring goes in the top groove and the oil control ring goes in the bottom groove.

A Lower expander end gap

B Lower piston ring end gap

C Upper expander end gap

D Upper piston ring gap

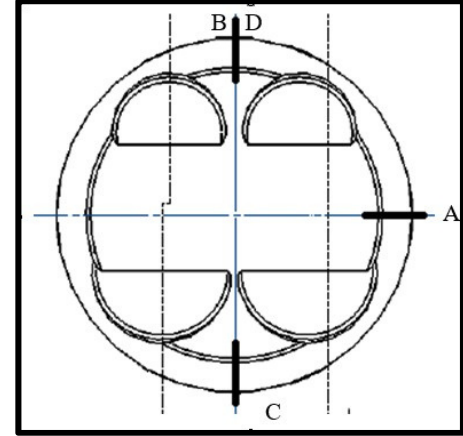

WARNING

The expander rings do not have a top or bottom; however the oil control ring and the compression ring must be installed with the « N » mark facing up.

- Apply engine oil to the wrist pin internal bore in the piston.
- Carefully note the piston orientation. (the small cut outs are on the exhaust side)

Use special tool number 1821 to maintain the piston in the correct location **1**.

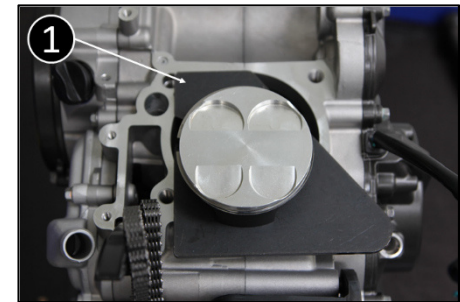

WARNING

Use the same head gasket. (Thickness 0.3 or 0.4mm depending on the model)

- Place one of the clips in the special tool number 2075 as shown in the photo; install the clip close to one end of the tool
- Use the tool to set up the clip for installation on the wrist pin.
- Install the circlip on the wrist pin

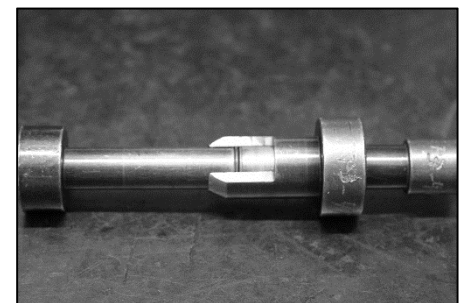

REASSEMBLING THE TOP END OF THE ENGINE

- Install the wrist pin into the piston and connecting rod using the tool and lightly tapping with a hammer.
- Install the opposite circlip, using the special tool.
- Install the cylinder over the piston using an appropriate ring compressor
- Install the two cylinder head locating pins [A].
- Install the head gasket [B].
- Install the cylinder head.

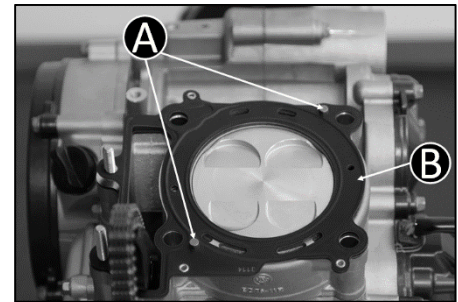
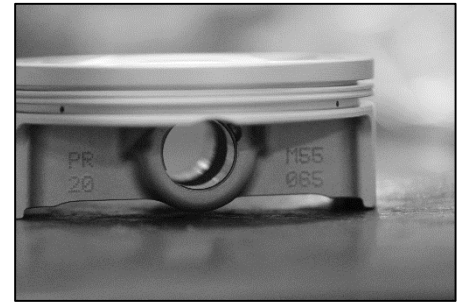

» Reassemble the cylinder head

WARNING

The two internal bolts are of different length and are equipped with washers.

- Install the head bolts noting the different lengths; tighten them using two passes in the order shown in the photo.
- Install and tighten the two M6 nuts.

Cylinder head torque:

Studs

1st pass: 30 Nm

2nd pass: 45 Nm

Nuts M6: 10Nm

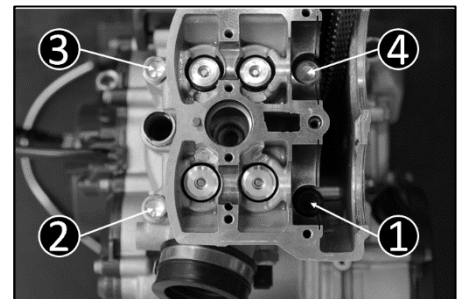

REASSEMBLING THE TOP END OF THE ENGINE

» Valve timing

- Beware if the tool number 1819 is still properly installed.
- Install the intake cam.
- Install the exhaust cam.
(see the picture for how to set the timing marks)
- Install the camshaft retaining clips.
- Apply moly disulfide grease to the camshafts

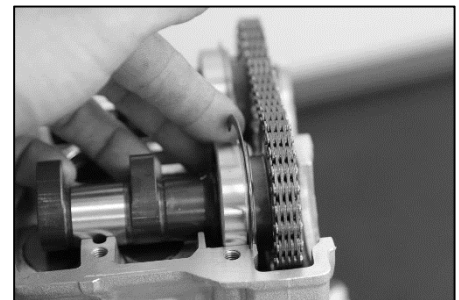
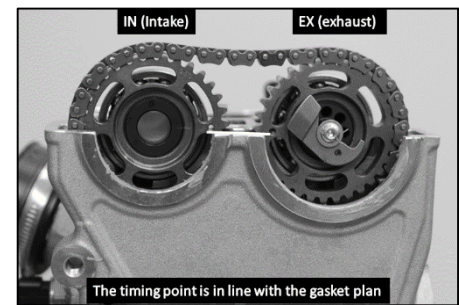
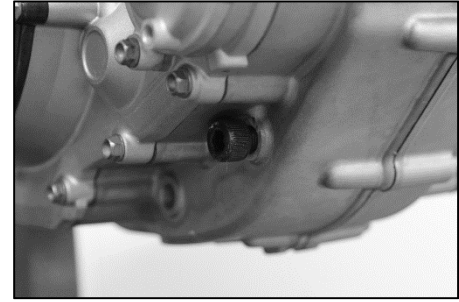

REASSEMBLING THE TOP END OF THE ENGINE

- Install the camshaft retaining cover. (pay careful attention to the tightening order).

Camshaft retaining cover torque 10Nm

WARNING
The screw n°1 is a M6 X 35

- Install the camshaft chain tensioner using a new gasket.

Torque the two fixing bolts to: 10Nm

- Install the cam tensioner adjusting bolt (pay attention to the o-ring).

Torque the tensioner adjusting screw to: 10Nm

- Remove the special tool number 1819.
- Rotate the engine a few times to make sure that the valve timing is correct.
- Finally check the valve timing using the timing marks.
- Replace the cap that was removed to install tool number 1819.

Torque the cap to: 8Nm

- Replace the spark plug well.

WARNING
Make sure that the o-rings are installed on the spark plug well.

- Apply a thin coat of silicone to the camshaft end cap bores.
- Replace the valve cover.
- Install the valve cover installation bolts.

Torque the bolts to: 8Nm

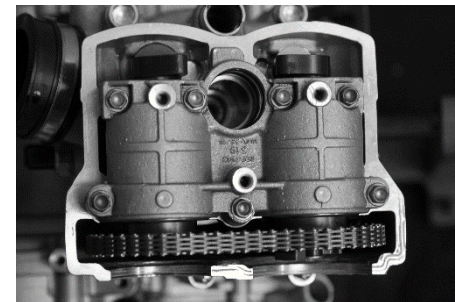
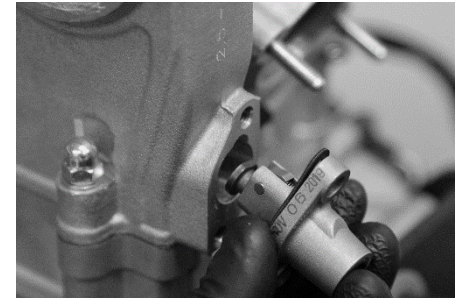
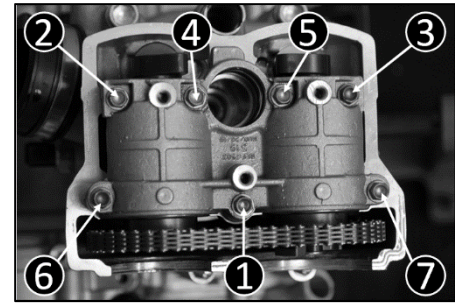

REASSEMBLING THE TOP END OF THE ENGINE

» Valve clearance

- The valve clearance must be checked when the engine is cold.
- Remove the spark plug and the valve cover.
- Remove the timing plug from the crankcase.
- Install special tool number 1819.
- With a feeler gauge measure the clearance between the bucket and the cam.

Valve clearance

Intake 0.15 – 0.20 mm

Exhaust 0.20 – 0.25 mm

- If the clearance is not correct then change the discs in order to obtain the correct gap.
- Remove the discs with a magnet.
- Measure the thickness of the disc and replace with one of the correct thickness.

Select the appropriate disc from the existing parts catalog

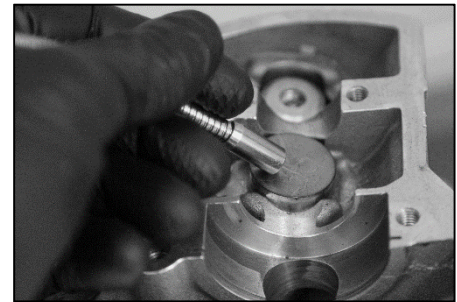
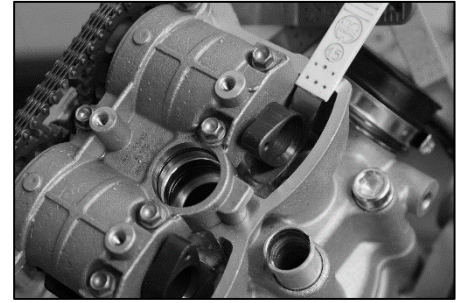

» Replacing the timing chain

- Remove the camshafts (see the chapter on the motor top end).
- Remove the clutch cover (see the chapter on « Right side » removing the clutch).
- Remove the chain tensioner adjuster.
- Remove the cam chain.
- Inspect the cam chain. (see «visually inspecting the cam chain»)
- Install the cam chain in the opposite manner in which it was removed.
- Reinstall the cam tensioner bolt and tighten to the correct torque.

Torque the cam tensioner bolt to: 10Nm.

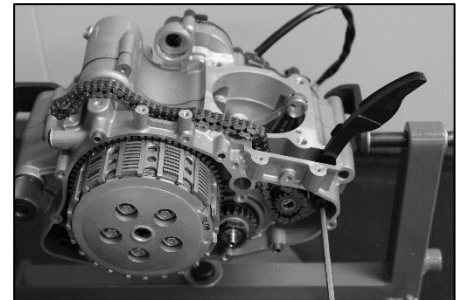

DISASSEMBLING COVER

DISASSEMBLING THE RIGHT SIDE

›) Clutch dismantling

- Install special tool number 1819.

WARNING

Only use this tool for disassembling the clutch, do not use it to remove the hub fixing nut.

- Remove the 4 screws that retain the clutch cover.
- Remove the 5 pressure plate screws (see the picture).
- Sort the discs and make sure they are trimmed and smooth.
Make sure that the clutch hub rotates freely.

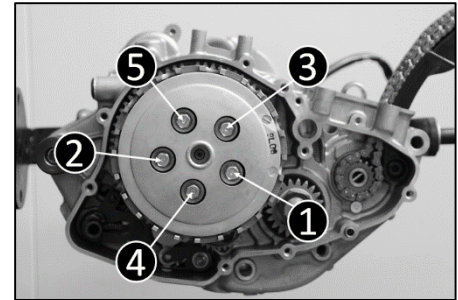

›) Inspection of the clutch

- Inspect the discs to make sure they are trimmed and smooth

Friction plate thickness

Standard: **2.95**

Limit: **2.7**

Deformation limit: **0.3mm**

Steel disc thickness

Standard: **1.4**

Limit: **1.3**

Deformation limit: **0.3mm**

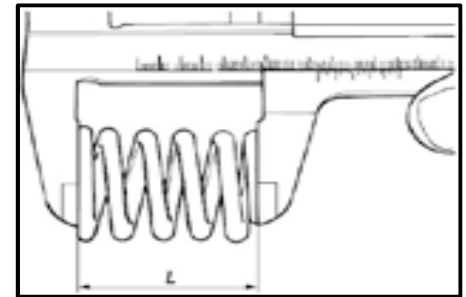

›) Check the clutch spring length

- Mesurer la longueur libre des ressorts.
Standard : 37.29mm
Limite : 36.5mm

Reassembly of the clutch

- Soak the friction discs in engine oil.
- Replace the discs on the hub by starting with a friction disc and then a steel disc ending with a friction disc.
- Replace the pressure plate.
- Install the 5 springs.
- Install the 5 screws and tighten in an alternating order (see the disassembly photo).
Torque the screws to:10Nm
- Reinstall the clutch cover, inspect the o-ring and replace if it is damaged



DISASSEMBLING COVER

› Disassembling and inspecting the water pump

- Drain the coolant by removing screw [A].
- Remove the screws from the water pump housing.
- Remove the water pump impeller using a 10 mm socket.

WARNING

If the seal is leaking, coolant will come out of the weep hole (see picture). In order to change the seal the clutch housing must be removed.

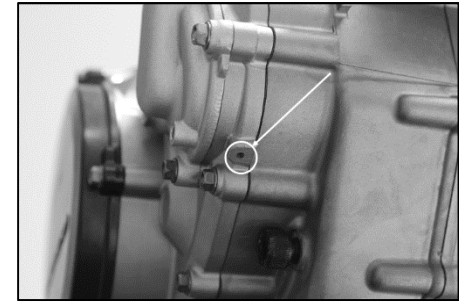
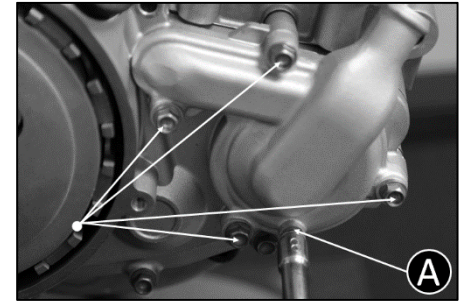

Changing the water pump shaft seal requires removing the clutch housing

- Remove the clutch housing.
- Remove the clip from the water pump shaft.
- Remove the water pump shaft.
- Remove the roll pin.
- Heat the clutch case in an oven to 70°.
- Extract the bearing.
- Put some grease like “molikote Dx” on the lips of the oil seal.
- Change the seal using special tool number 1968.

WARNING

Make sure the seal is installed properly. You should see the spring when you look at the seal. (see picture)

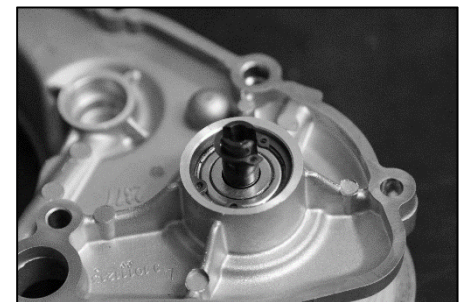
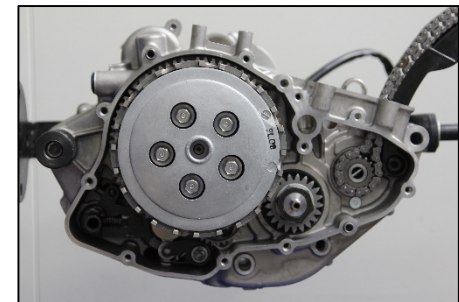

- Check the bearing, if it requires changing use special tool number 1822.
- Reinstall the parts in the reverse order of their removal. Pay careful attention to the clutch housing locating pins, always install a new paper gasket and if necessary install a new o-ring seal on the water pump housing.

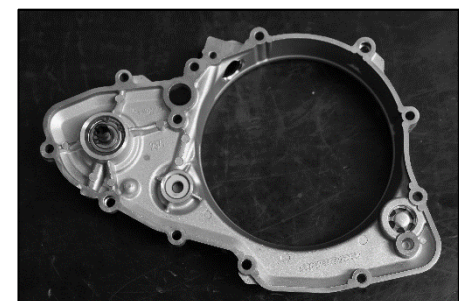

Tighten the water pump housing screws to: 10Nm.
Tighten the coolant drain plug to: 6Nm.

DISASSEMBLING COVER

› Removing the clutch hub and the clutch basket

- Drain the engine oil and the engine coolant.
- Remove the clutch housing.
(see disassembling the right side paragraph)
- Remove the clutch.
(see clutch removal paragraph)
- Remove the clutch release bearing assembly.
- Retain the clutch hub using tool 1814.
- Loosen the clutch hub nut.

WARNING

Make sure the special timing tool number 1819 is not installed, if it is, severe damage could occur to the crankshaft and crankcase.

- Remove the hub and the nut.
- Inspect the needle bearings and replace if necessary.
- Visually inspect the hub and the housing.

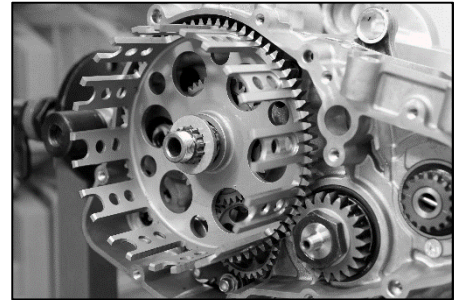
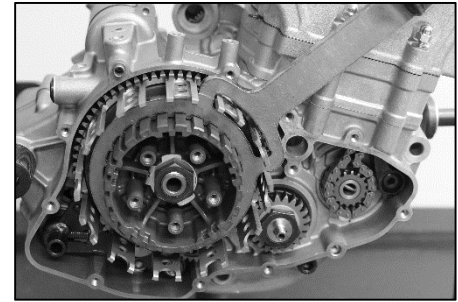
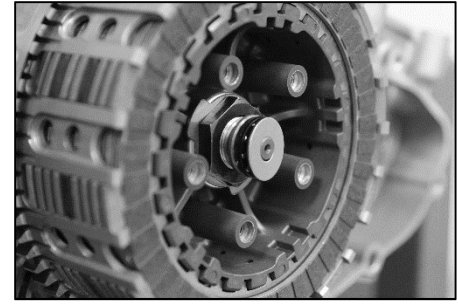

› Reassembling the clutch hub components

- Install the thrust washer.
- Install the needle bearings.
- Install the clutch housing.

WARNING

The clutch basket wheel is appeared with the primary gear.

- Install the spacer washer.
- Install the clutch hub.
- Install the special washer.
- Grease the threads of the shaft and the nut.
- Apply thread locker (blue) to the nut thread.
- Install the fixing nut
Torque the fixing nut to: 80Nm.

- Check for free rotation of the clutch hub.
- Blend the special washer over the nut.
- Install the seat, judder spring

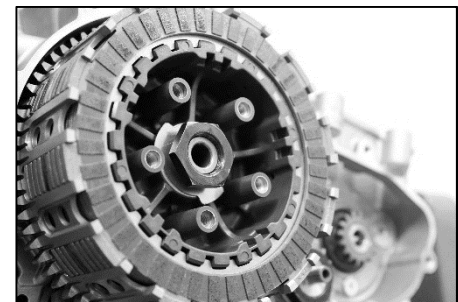
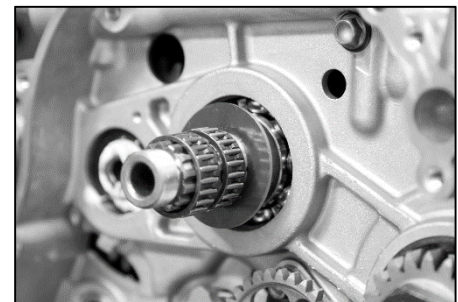

DISASSEMBLING COVER

WARNING
There is a sense

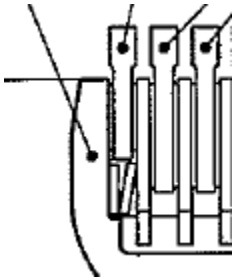

- Install the special friction disc.
 - Install all the metal and friction discs.
 - Reinstall the clutch release bearing assembly, the clutch spring holder in the reverse order of their removal.
- Torque the clutch screws to: 10Nm**
- Install the clutch cover dowels, a new clutch cover gasket and tighten to 10Nm

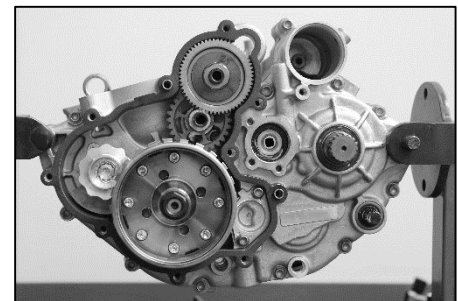
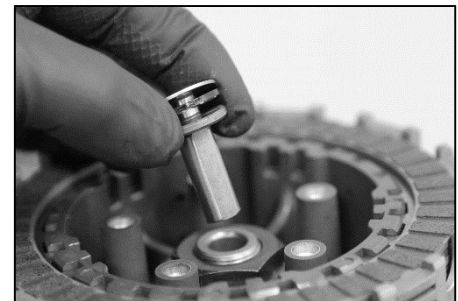
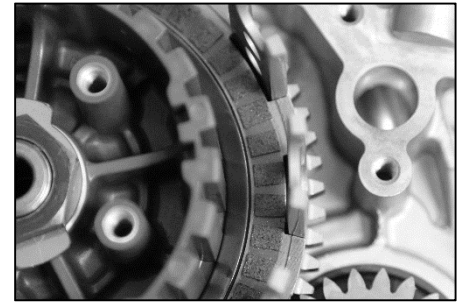
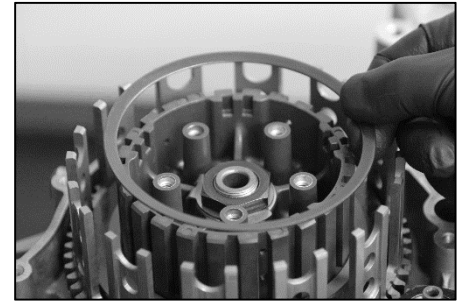

DISASSEMBLING THE LEFT SIDE

›) Disassembling the ignition case

- Drain the engine oil.
- Remove the 10 screws that retain the ignition case.
- Visually inspect the inner surfaces of the rotor [A] and the outer surfaces of the stator [B].
- Check the pulse generator (sensor)
- Replace if necessary

WARNING
There is a sense

›) Replacing the stator and sensor system

- Remove the 2 screws that retain the sensor [C] and the 2 screws that retain the stator [D].
 - Install the new parts.
 - Reinstall the screws using the proper torque with strong Loctite (red)
 - Do not forget the AET washers below the stator screws.
- Torque the stator and sensor screws to: 8Nm.**

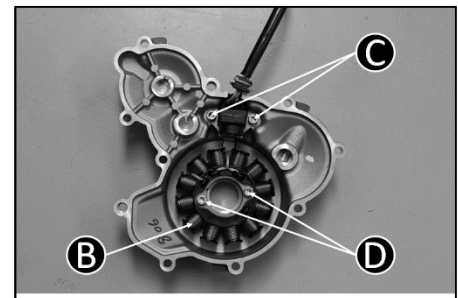

DISASSEMBLING COVER

›) Removing the rotor

- Use the special rotor holding tool number 4753.
- Remove the rotor fixing nut.
- Remove the flywheel using special tool number R462.
- Remove the two starter shafts along with the starter gears.
- Remove the oil centrifuge (back-flow).

WARNING

The threads this screw are LH, do not turn the wrong direction.

- Remove the free wheel gear.

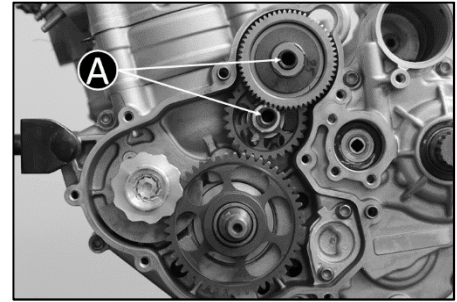
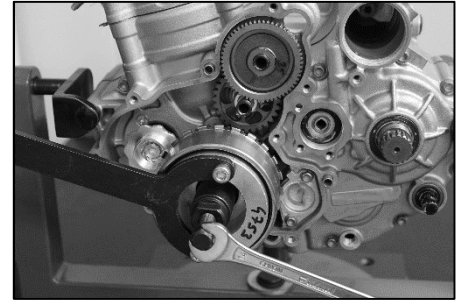

›) Inspect the freewheel and the needle bearings

- Visually inspect the caged needle bearings.
- Replace if necessary.
- Inspect the track of the freewheel gear.
- Replace the freewheel gear if necessary.
- Dismount the free wheel from the rotor by loosening the 8 M5 screws.
- Inspect the free wheel housing.
- Replace if necessary.
- Finally check the rollers on the freewheel.
- Replace if necessary.

WARNING

If the freewheel must be replaced then the rest of the gears must be replaced and vice versa.

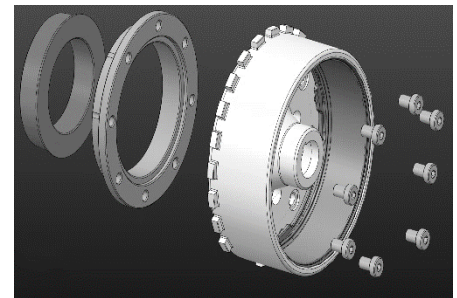

DISASSEMBLING COVER

» Reassembling the ignition case

- Install the free wheel gear.
- Reinstall the two starter shafts and their gears.
- Visually inspect the oil seal on the oil centrifuge.
- Use special tool number 1818 to screw the oil centrifuge.
- Apply thread locker (blue) to the oil centrifuge thread.

WARNING

This screw thread is reverse this is a LH thread.

- Screw and tighten the centrifuge.
Torque the centrifuge fixing screw to: 8 Nm.
- Inspect the rotor key, change if necessary.
- Pre assembly the rotor group
- Assembly the free wheel in its housing. Tighten this set to the rotor with the 8 M5 screws (apply thread locker blue on the screws).

Torque the M5 screw to: 8 Nm.

- Install the rotor (turn the rotor counter clockwise to help facilitate the installation of the lighting rotor).
- Apply proper tightening torque to the nut on the rotor with strong thread locker.
- Install the conical washer.
- Using special tool number 4753 to hold the rotor tighten the fixing nut.

Torque the fixing clutch nut to 80 Nm with thread locker (blue).

WARNING

Check the clearance between the rotor and the oil centrifuge.

- Install the remaining shafts and gears.
- Install the two case locating pins.
- Install a new gasket.
- Install the ignition crankcase cover and tighten the 10 screws.

Torque the ignition crankcase cover screws to: 10 Nm

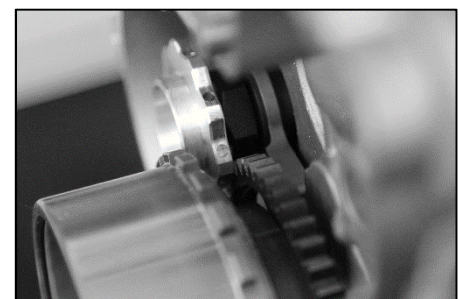
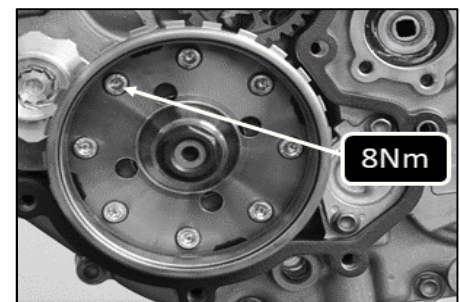
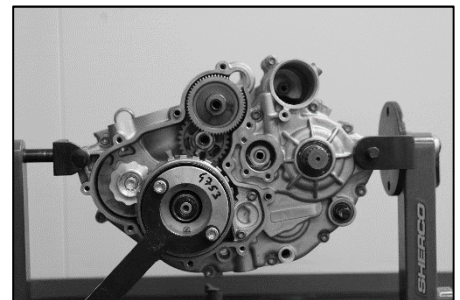
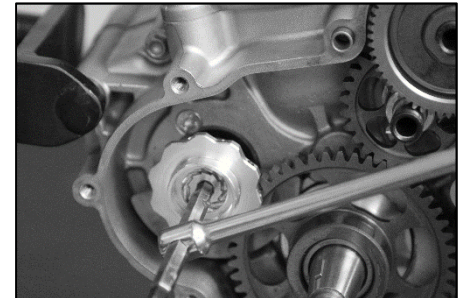
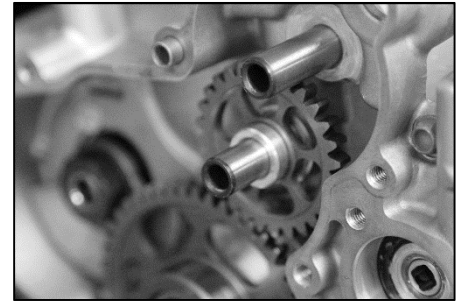
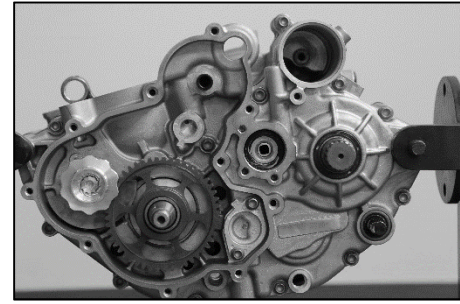

CRANKSHAFT - TRANSMISSION - CENTRAL CRANKCASES

› Disassembling the transmission and the crankshaft

- Remove the engine from the frame (see the engine removal chapter).
- Remove the top end (see the top end chapter).
- Remove the ignition components (see the ignition chapter).
- Remove the clutch components (see the clutch chapter).
- Remove the cam drive chain (see the top end chapter).
- Remove the cam chain tensioner and guides.
- Block the transmission primary gear with special tool number 1817.
- Loosen the fixing nut for the counter balancer.
- Remove the counter balancer weight.
- Remove the freewheel / crankshaft spacer using a two-armed gear puller. (see photo)
- Remove the engine oil pump cover.
- Block the transmission primary gear with special tool number 1817.
- Remove the transmission primary gear.
- Remove the clutch basket, the needle bearings and the thrust washer.
- Remove the primary transmission gears.
- Remove the oil pump drive gear.
- Remove the oil pump cover.
- Remove the oil pump rotor.
- Remove the oil pump shaft.
- Remove the gear selector shaft.
- Using special tool number 2073 block the gear selector drum and remove the gear selector index wheel screw.
- Remove the gear selector index wheel.
- Remove special tool number 2073.
- Remove the starter motor.
- Loosen and remove the 13 central crankcase screw.

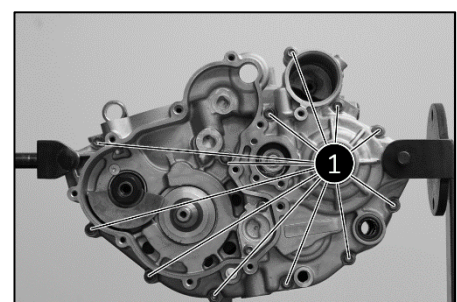
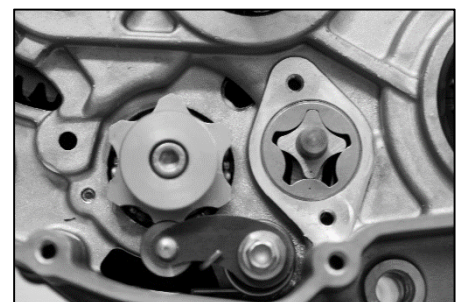
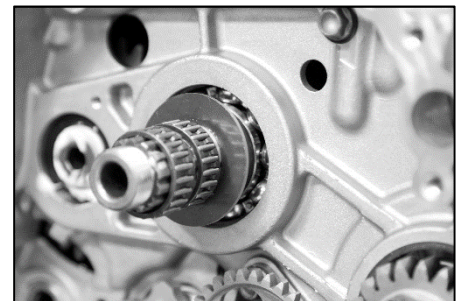
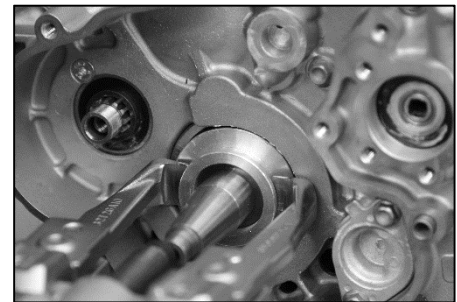
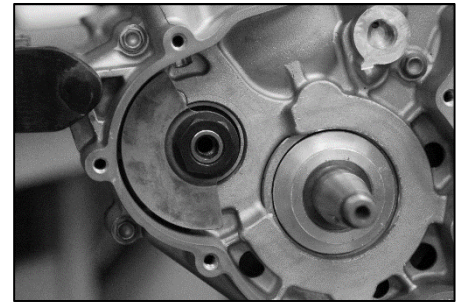
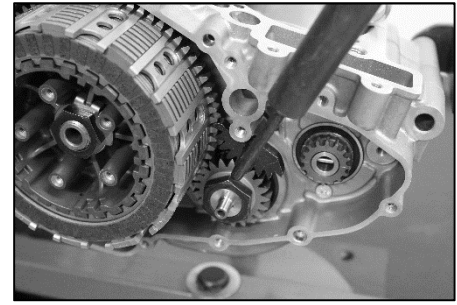

DISASSEMBLING CRANKCASES

- Remove the right side crankcase.
- Remove the crankshaft.
- Remove the counter balancer assembly.
- Remove the shifting fork shafts.
- Remove the gear selector drum.
- Remove the shift forks.
Remove the remaining transmission components.

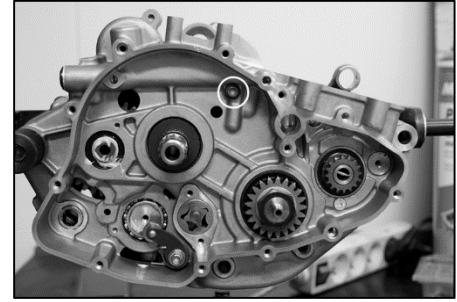

›) Checking the transmission components

- Check the condition of all the gears.
- Inspect the engagement dogs [A], look at all of the gear teeth [B] and the fork shifting groove on each gear [C].
If any of the parts are damaged or badly worn they should be replaced.
- Check the condition of all the shifting forks.
Replace the shifting forks if necessary.
- Check the condition of the gear selector drum, make sure it is not deformed, damaged or badly worn.
Replace the gear selector drum if necessary

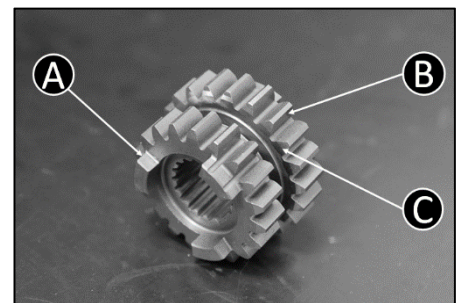
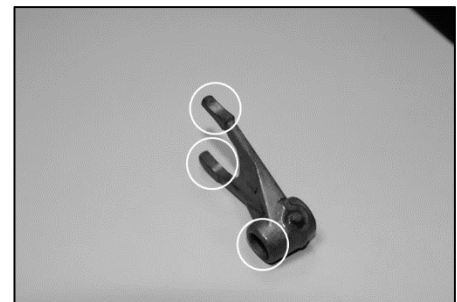
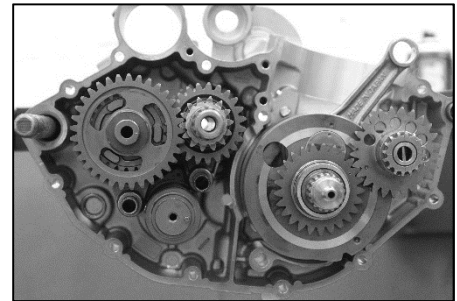

» Checking the crankshaft

Radial play of the big end bearing

- Place the crankshaft in a set of V blocks and install a dial indicator as shown [A].
- Push the rod [B] in the direction of the indicator and then push it in the opposite direction. The difference between these two readings is the radial play.

Radial play of the big end bearing:

Standard: 0.015 mm – 0.020 mm

Tolerance limit: 0.06 mm

If the radial play exceeds the tolerance limit the crankshaft must be replaced

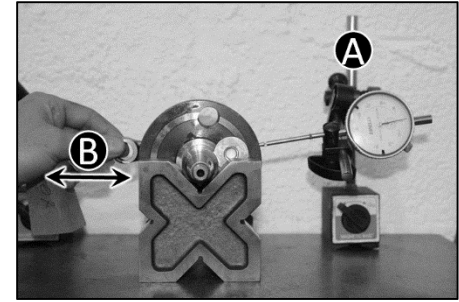

Lateral movement of the big end

- Measure the lateral movement of the big end [A].

Lateral movement of the big end:

Standard: 0.2 mm - 0.3mm

Tolerance limit: 0.55 mm

If the lateral movement of the big end exceeds the tolerance the crankshaft must be replaced

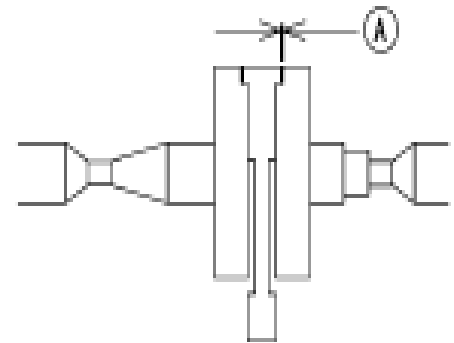

Checking the run out

- Place the crankshaft in a lathe or suitable support, place dial indicators as shown.
- Turn the crankshaft and record the readings. The maximum difference between the readings is the crankshaft run out.

Run out:

Standard: 0.02 mm maximum

Tolerance limit: 0.08 mm

If the run out exceeds the tolerance, replace the crankshaft or straighten it so that it meets the tolerance.

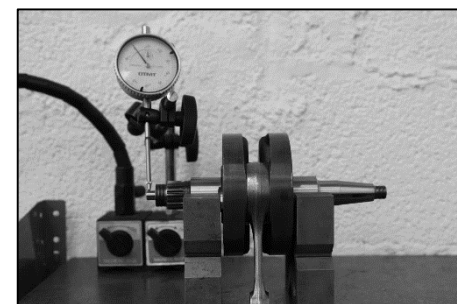

DISASSEMBLING CRANKCASES

› Checking the crankcase

- Inspect the general condition of the center

WARNING

During the rebuild, replace all seals (paper, seal, o-ring...).

crankcases for wear and cracks.

Replace the center crankcase if necessary.

- Inspect the condition of all the bearings. Replace the bearings if necessary.
- Inspect the condition of the crankshaft bearings. Replace the crankshaft bearings if necessary.
- To remove the bearings, install tool number R464, heat the tool and the bearing.
- Remove the bearing.

WARNING

The radial play in the roller bearings must be practically zero.

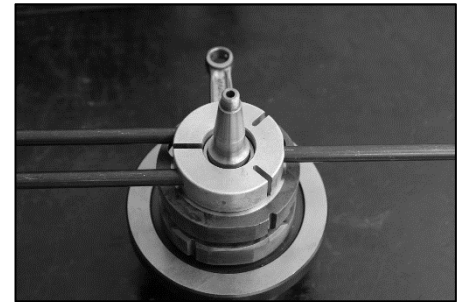
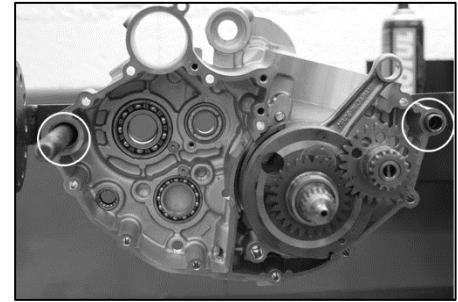

› Reassembling the central crankcase assembly

WARNING

The center shift fork shaft is the smallest in diameter.

WARNING

Do not forget to lubricate all of the rotating and sliding parts.

- Install the crankshaft and counter balancer assembly in the left case, align the marks as shown.
- Install the transmission gear along with their corresponding shafts.
- Install a new roller on each shift fork.
- Install the shift forks in the transmission in their respective grooves.
- Install the gear selector drum.
- Place the shift fork rollers in their respective grooves in the drum. Install the shift fork shafts
- Replace the two locating dowels in the case and install the washer on the transmission secondary shaft.

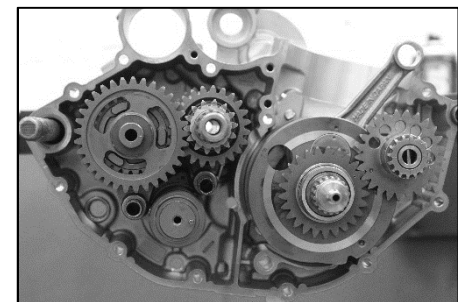
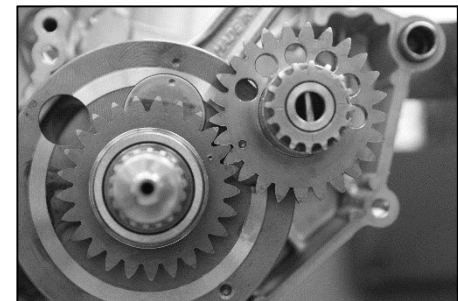

- Install the 2 centering pins and the wash on the secondary shaft.

WARNING:

During the replacement of the gearbox or the crankcase on the 250-300 4t engines, it is necessary to check the side play of the primary shaft and adjust it if it is necessary

INSPECTION OF THE PRIMARY SHAFT SIDE PLAY

- Fit the tool re 8945 in the right crankcase, in place of the right side primary shaft bearing 0874.
- Fit the gearbox inside of the left, fit the crankcase, the gasket and close the engine.

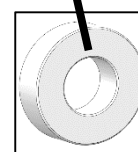
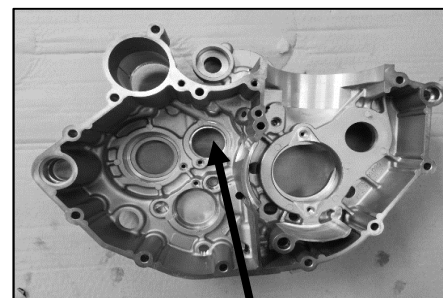

- Using a comparator, check the side play of the primary shaft.
- Remove the right side crankcase and remove the tool. Adjust the side play placing a shim washer between the crankcase and the bearing 0874.

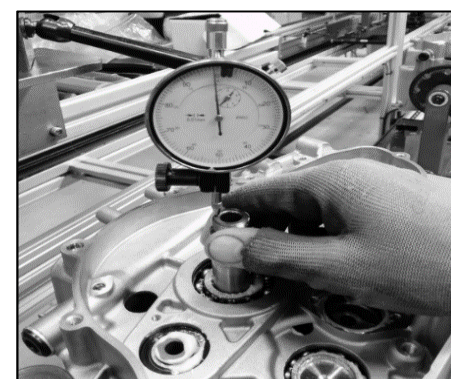

The side play has to be between 0 et 0,1mm.

Shim washer	
Dimension	REF
0,5mm	8920
0,4mm	8921
0,3mm	8922
0,2mm	8923
0,1mm	8924



REASSEMBLING CRANKCASES

- On the right hand case make sure the breather jet is in place.
- Place the right case on the left case previously fabricated.
- Install the 13 screws that retain the two halves together.
Torque the 13 center crankcase screws to: 10 Nm.

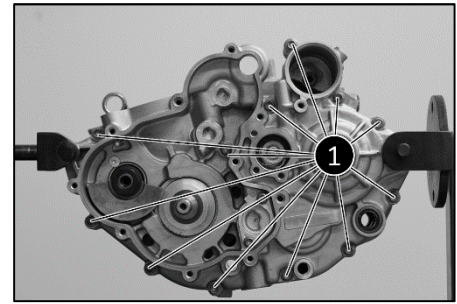

- Install special tool number 2073 to keep the gear selector drum from rotating.
- Install the locating pin, the gear selector index wheel and the fixing screw.
Torque the gear selector index wheel fixing screw to: 10 Nm.
- Remove the special tool number 2073.

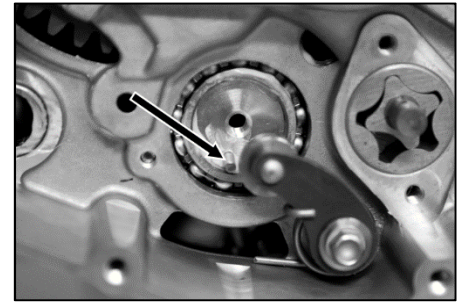

- Install the gear selector shaft.

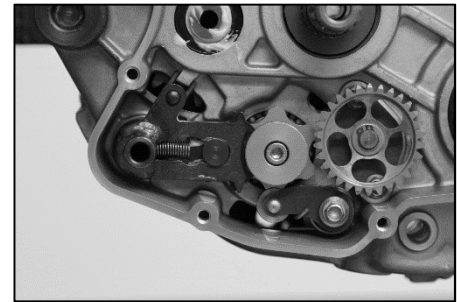

- Install the oil pump shaft, the roll pin and the internal oil pump rotor.
- Install the oil pump cover and tighten the cover screws to the appropriate torque.
Torque the oil pump cover screws to: 5 Nm.

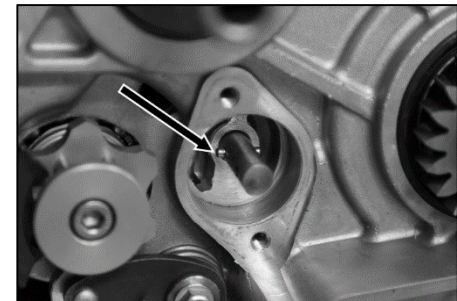

- Install the oil pump drive roll pin, the drive gear and the cir clip.
- Install the primary drive gear.

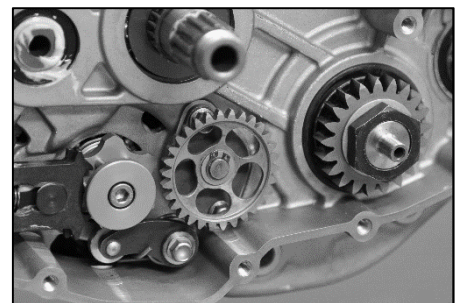

- On the transmission input shaft install the thrust washer, the needle bearings the clutch basket, the spacer washer, the clutch hub and the conical washer.
- Using an appropriate solvent clean the crankshaft threads and the input shaft threads.

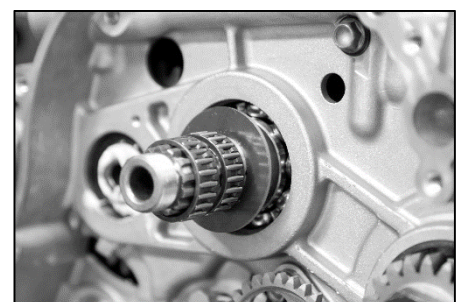

REASSEMBLING CRANKCASES

- Install the fixing nuts on the crankshaft and the transmission input shaft.
- Apply the proper torque these fixing nuts.
- Install special tool number 1817 and torque the crankshaft fixing nut.

Torque the crankshaft fixing nut to: 120 Nm.

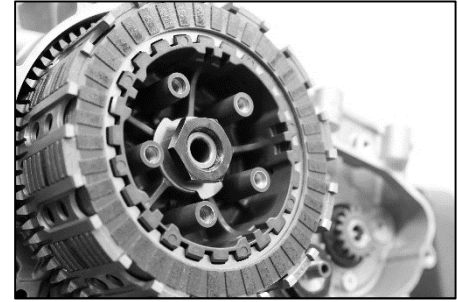

- With the special tool still installed, torque the transmission input fixing nut.

Torque the transmission input fixing nut to: 80 Nm.

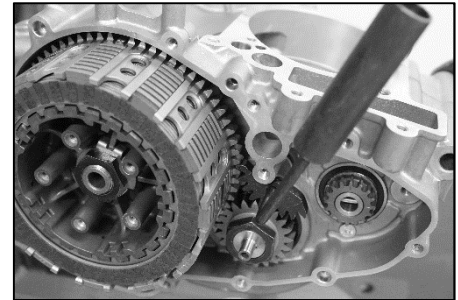

- Use tool 1817 to block the transmission and to tighten balancer nut.

-Torque of balancer nut 60 Nm + thread locker.

- Install the oil pump drive roll pin, the intern rotor and fixing nut to the cover.

-Torque of the oil pump cover : 5 Nm.

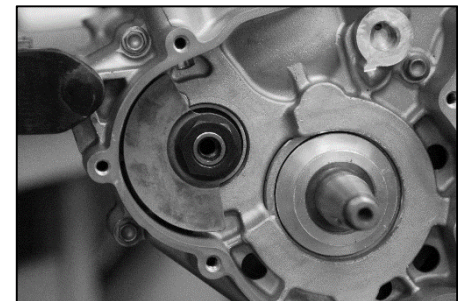

- Heat the crankshaft spacer ring (Ref 1732) to approximately 70 degrees and install it on the crankshaft.
- Replace the freewheel assembly and the starter drive gear train (see the paragraph on disassembling the left side).
- Reinstall the starter.

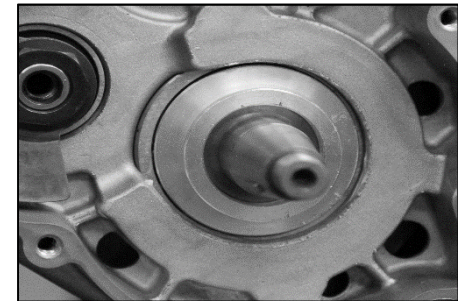

- Reinstall the motor top end (see the paragraph on the top end).

- Install the cam drive chain (see the paragraph on top end).
- Install the clutch (see the paragraph on disassembling the right side).

- Install the clutch cover.
- Install the spark plug.

-Torque the spark plug to: 15 Nm.

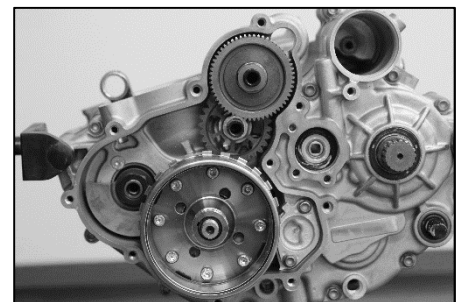

WARNING

Apply thread locker to all of the internal engine threads except the five clutch pressure plate fixing screws.



TIGHTENING TORQUES

STANDARD TORQUE		THREADLOCKER
M5	6 Nm	
M6	10 Nm	
M8	24 Nm	
M10	40 Nm	
MOTOR TIGHTENING TORQUES		THREADLOCKER
Magnetic drain plug	15 Nm	
Drain plug with prefilter	15 Nm	
Oil filter cover	15 Nm	
Spark plug (with copper grease)	15 Nm	
Bolt for bleeding cooling system	6 Nm	
Ignition sensor screw	8 Nm	•
Bolt for draining cooling system	6 Nm	
Clutch slave cylinder screw	9 Nm	
Exhaust bolt	10Nm	
Cylinder head :		
1 ^{er} passe	30 Nm	
2 ^{ème} passe	45 Nm	
Ecrous M6	10 Nm	
Camshaft cap	10 Nm	
Chain tensioner screw (x2)	10 Nm	
Chain tensioner screw (x1)	10 Nm	
Timing control plug	8 Nm	
Chain guide screw	10 Nm	•
Clutch pression screw	10 Nm	
Water pump cover	11 Nm	
Rotor nut	80 Nm	•
Clutch nut	80 Nm	•
Oil breather wheel	8 Nm	
Ignition cover	10 Nm	
Crankcase screw	10 Nm	
Gear selector drum screw	10 Nm	
Oil pump cover	5 Nm	
Balancer nut	60 Nm	•

TIGHTENING TORQUES

FRAME TIGHTENING TORQUES		THREADLOCKER
Rear wheel axle nut	100 Nm	
Aluminium sub frame bolts	24 Nm	•
Front wheel axle nut	40 Nm	
Front fork / axle bolts / axle M6	15 Nm	
Brake pad bolt	8 Nm	•
Bottom plate fork bolts	12 Nm	
Upper plate fork bolts	17 Nm	
Motor screw	60 Nm	
Swing arm nut	100 Nm	
Cylinder head-frame screws	23 Nm	



INJECTOR BODY

Clean injector body

›| Material

- MOTUL Net Carb or parts cleaner
- Allen keys of 2.5
- Screwdriver with 7mm dowel
- Wrench of 8



›| Put down the injector body

- Remove the seat
- Remove the fuel tank
- Remove the injector body clamps
- Remove the throttle body cover
- Remove the throttle cable
- Remove the injector body



INJECTOR BODY

- Disconnect each connector
- Visually inspect the connector



- Clean with carb cleaner or universal product cleaner
- Blow



INJECTOR BODY

›| Clean of injector body

- Clean the injector body with Net Carburetor
- Make sure you clean perfectly the edge of the mixture throttle on each side by opening it completely
- Clean the injector

- Blow



›| Replace the injector body

- Put back all the parts together again, put some connector grease inside the electrical connectors (TPS plug, injector plug)
If you dismantle the throttle body manifold, be careful with the sense of this part!



- Set the throttle cable
- Disconnect the ECU connector. Inspect it
- Clean with carb cleaner or universal product cleaner
- Blow



- Apply connector grease

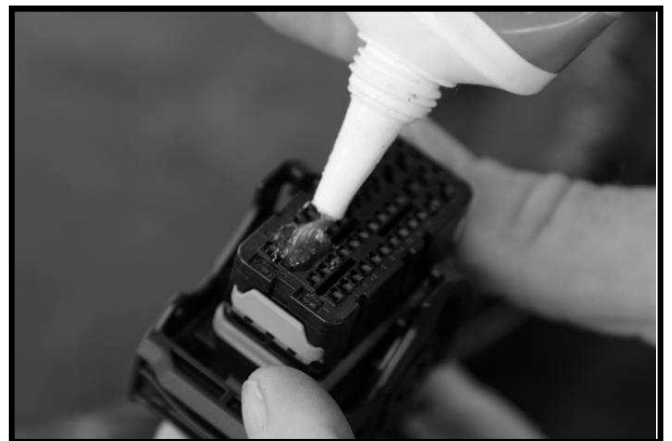

ELECTRICAL INSTALLATION CHECKING

1- Fan control

- Disconnect the fan wiring harness.
- Connect a 12V battery directly to the fan as shown on the diagram.
- Make sure the fan turns correctly without any hard point or unnatural noise.

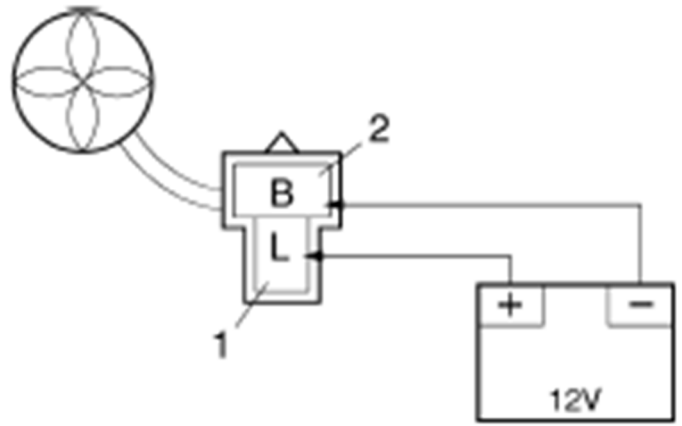

2-CDI

1	VSENS	CAN_H	CAN_L	CPS -	CPS +	protecte d	protecte d	protecte d	protecte d	Main Relay	VBR	IGN
2	ACC_PLY	Pwm Gauge	Canister Purge	TSW	protecte d	MAP	SGND2	protecte d	Stop SW	FAN Motor (optional)	Hego HEATER	protecte d
3	ACC_PLY	MIL	SGND1	STA2	ground	TIA	TPS	VEH SPEED	Carbs SW	protecte d	FUEL pump	PGND
4	VBK	VBD	STB2	STA1	STB1	TCO	Hego sens	protecte d	Carbs SW	protecte d	INJ (I)	PGND
	A	B	C	D	E	F	G	H	J	K	L	M

- Grounds
- Supplies
- Logic or Freq inputs
- VR Freq inputs
- Freq outputs
- Analog inputs
- Logic or Analog inputs
- Communications lines
- 1A outputs
- ATM36 outputs
- Ignition

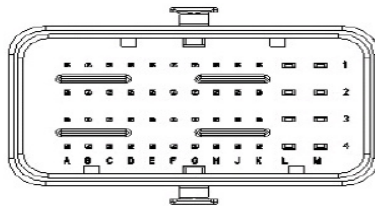

3-Fuel pump control

- Disconnect the fuel pump hose and connect the pressure measuring tool ref: **8691**.
- Pressurize the pump by operating the starter
- A constant pressure of **3 bars** must be measured.

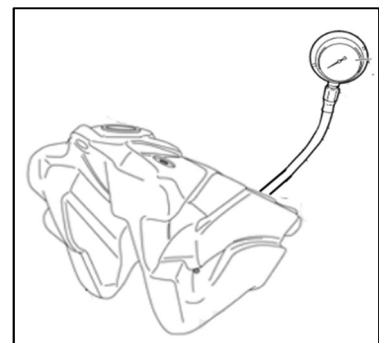

Fuel pump supply control

- Connect a multimeter between the positive terminal of the pump (green wire) and the negative terminal of the pump (blue wire).

Supply voltage 12V

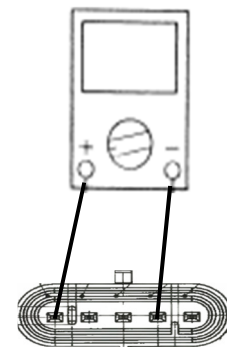

›| 4-Fall sensor control

- Remove the sensor from its location, leaving me connected to the electrical harness.
- Using a multimeter , measure the output voltage of the angle sensor. Positive plug on the blue wire and negative on the black wire.

Sensor values:

Under 65°: 0.4 – 1.4V

Over 65°: 3.7 – 4.4 V

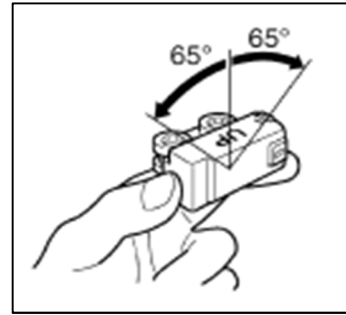

›| 5-Checking the voltage regulator

- Voltage regulator :

On regulator output (White wire)
A 3500 Tr/min : 14.4V +/- 0.5V

- Diode bridge check :

Connect a multimeter between the positive (white wire) and each of the phase (yellow wire).

Resistance should be noted in a sense of measurement.

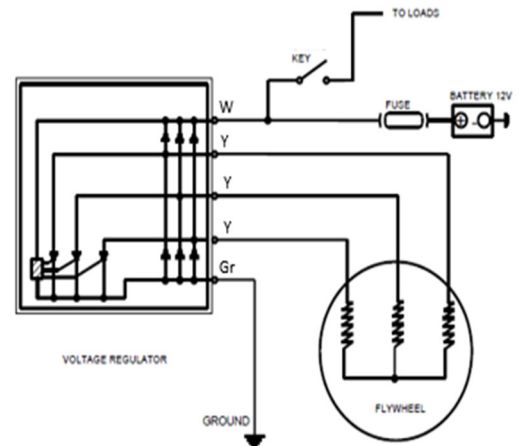

›| 6-Battery control

- Connect a multimeter to the + and the – terminals of the battery and check its voltage

Battery and check its voltage.

Value readings:

12.8V → Charged battery

12.7V or under → Charge battery

Under de 12V → Replace battery



7-Map sensor control

- Check the output voltage of the sensor.
- Connect the multimeter to the sensor (harness side) between terminal N°3 (positive) and terminal N°4 (negative).

Then, between terminal N°1 (positive) and terminal N°4 (negative).

Sensor output voltage :

Between 3 and 5 V

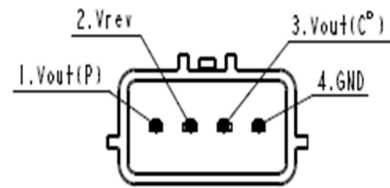

8-TPS sensor control

- Measurement of the output voltage of the TPS sensor.
- Connect a multimeter to the output terminals of the TPS sensor (Positive [B] – negative [A]) by keeping it in the fully closed position:

TPS sensor output voltage : 0.4V – 0.6V

- TPS sensor input voltage measurement.

Connect a multimeter to the input terminals of the TPS sensor (Positive [C] – negative [A]).

TPS sensor input voltage : 5V

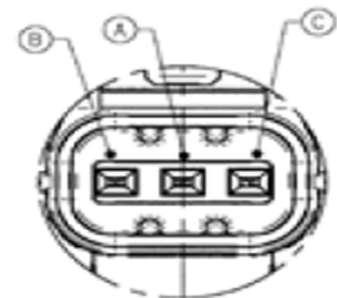
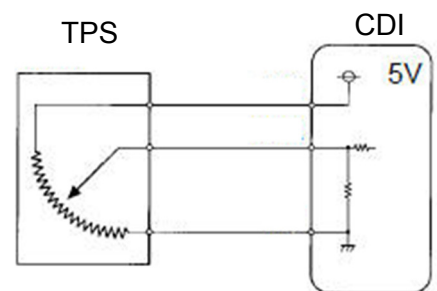

- Measurement of the resistance TPS sensor:
- Remove the injection body and measure the resistance directly across the sensor.

Butterfly closed :

Between + (rouge) et – (noir): 5 +/- 20%

Between signal (bleu) et – (noir): 1.25 à 1.55

Between signal (bleu) et + (rouge): 5.3 +/- 20%

Butterflu opened :

Between + (rouge) et – (noir) : 5 +/- 20%

Between signal (bleu) et – (noir) : 4.6 +/- 20%

Between signal (bleu) et + (rouge) : 2.05 +/- 20%



9-Stepper motor control

- Checking the stepper motor coils.
- Connect the multimeter to the sensor (harness side) between terminal N°A and terminal N°D.

Then, between the terminal N°B and terminal N°C.

There must be continuity between the terminals ; if not, replace the motor.

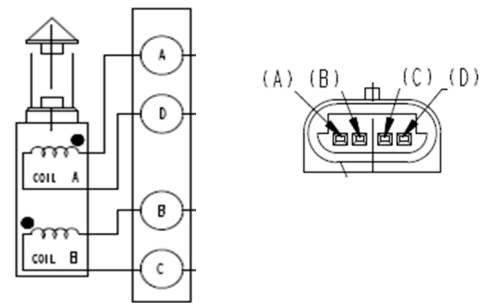

10-Injector control

- Measure the input voltage of the injector.
- Connect a multimeter between the green supply wire and the earth.

Injector supply voltage : 12V

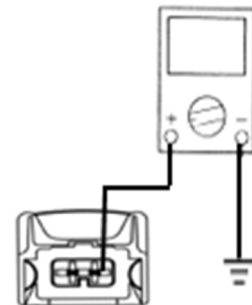

11-Starter control

- Remove the starter and position it in a vice
- Connect a battery directly to the starter (positive on the starter terminal, negative on the starter body) as shown on the diagram.
- In the event of abnormal operation, open the starter body to clean the contact between the carbon brushes and the starter track.

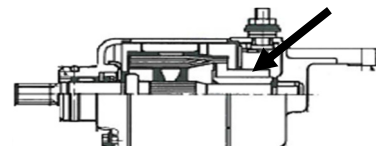
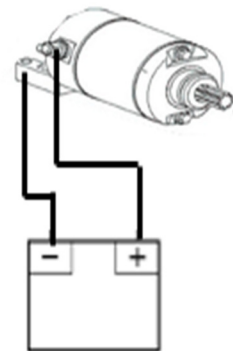

›| 12-Checking the alternator

- Checking the resistance of the alternator windings.

Connect the multimeter between each phase of the alternator (yellow wire) and measure the resistance.

Winding resistance: $0.44\Omega \pm 15\%$

- Checking the alternator output voltage.

Connect the multimeter between each phase of the alternator (yellow wire) and ground (multimeter in alternating position)

Measure the output voltage.

At idle speed: $22V \pm 2V$

At 6000 R/min: $77V \pm 3V$

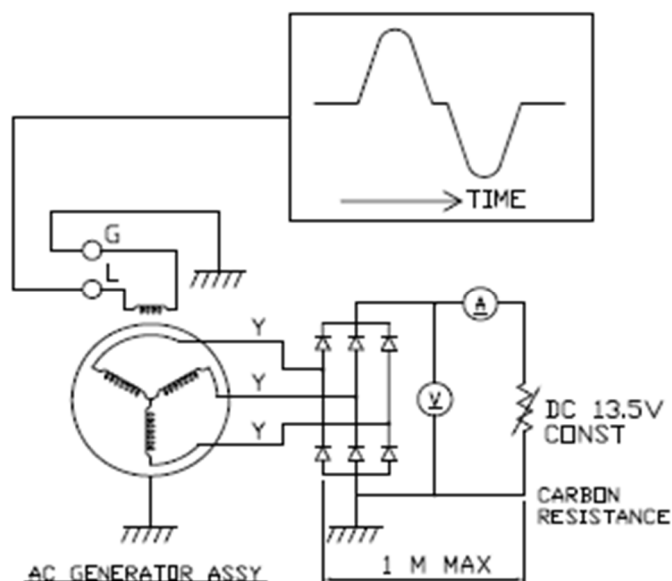

›| 13-Hall sensor control (Crankshaft)

- Sensor resistance check.

Connect the multimeter between the blue and green wires of the sensor and measure the resistance.

Sensor resistance: $120\Omega \pm 10\%$

- Check the output voltage of the sensor.

Connect the multimeter between the blue and the ground, and check the voltage.

At 300 R/min: 1.7V minimum

At 10000 R/min: 120V maximum

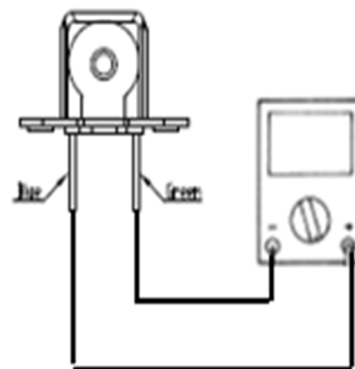

14-Water sensor control

- Drain the coolant.
- Remove the temperature probe.
- Immerse the sensor 1 in a container filled with coolant 2.
- Immerse a thermometer 3 in the liquid to check its temperature.
- Heat the liquid slowly and check the resistance of the sensor using a multimeter connected as shown in the diagram depending on the temperature of the liquid, referring to the table below.

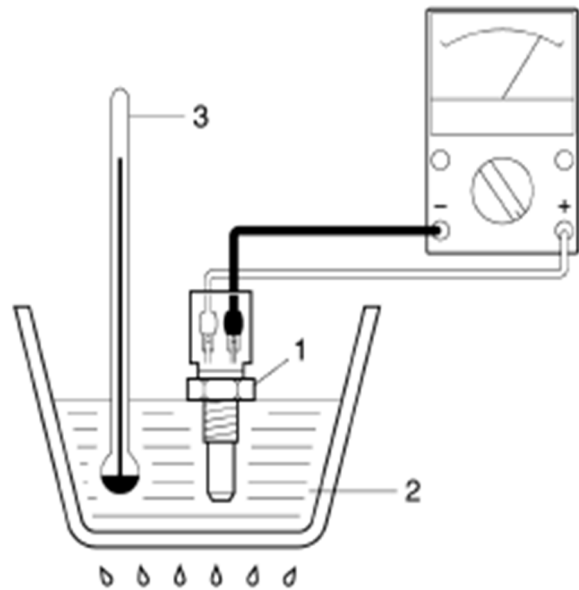

TEMPS (°C)	RESISTANCE (Ω)
25	3000
30	2415
40	1620
50	1081
60	748
70	528
80	379
90	278
100	206

15-Ignition coil control

- Checking the resistance of the primary coil.

Connect the multimeter as shown in the diagram and measure the resistance.

Primary winding resistance :
Between 0.85 and 1.5 Ω

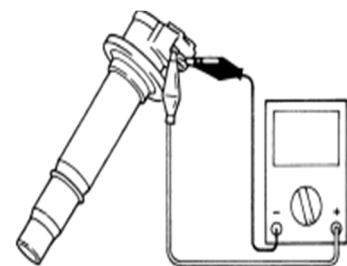

- Checking the resistance of the secondary coil.

Connect the multimeter as shown in the diagram and measure the resistance.

Secondary coil resistance :
Between 10 and 14 KΩ

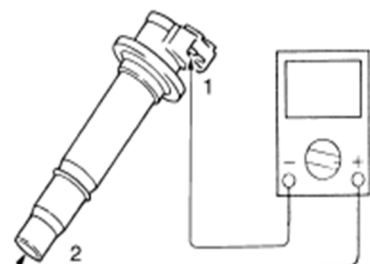

Homologated light wire harness (8145)

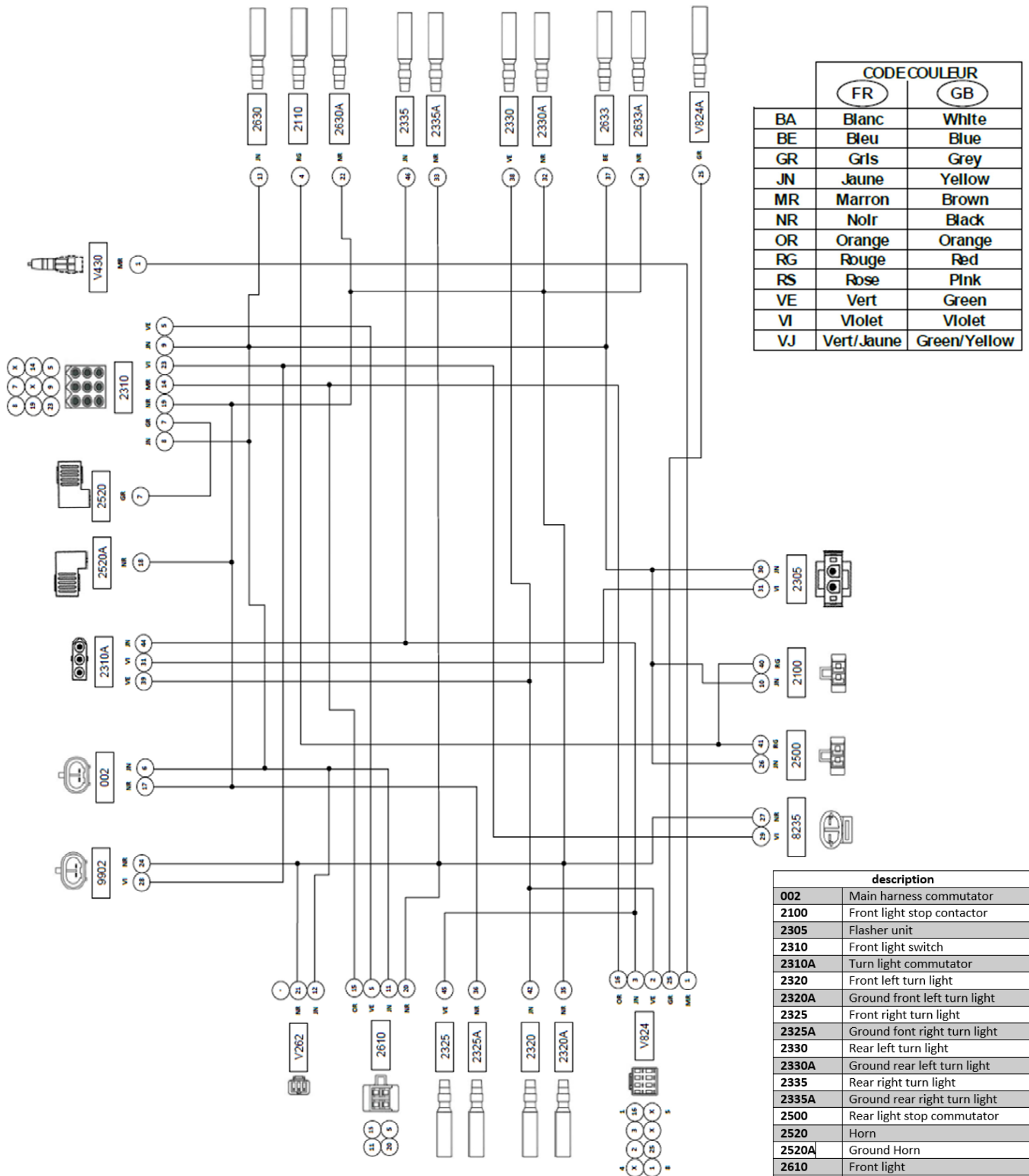

CODE COULEUR		
	FR	GB
BA	Blanc	White
BE	Bleu	Blue
GR	Gris	Grey
JN	Jaune	Yellow
MR	Marron	Brown
NR	Noir	Black
OR	Orange	Orange
RG	Rouge	Red
RS	Rose	Pink
VE	Vert	Green
VI	Violet	Violet
VJ	Vert/Jaune	Green/Yellow

description	
002	Main harness commutator
2100	Front light stop contactor
2305	Flasher unit
2310	Front light switch
2310A	Turn light commutator
2320	Front left turn light
2320A	Ground front left turn light
2325	Front right turn light
2325A	Ground front right turn light
2330	Rear left turn light
2330A	Ground rear left turn light
2335	Rear right turn light
2335A	Ground rear right turn light
2500	Rear light stop commutator
2520	Horn
2520A	Ground Horn
2610	Front light
2630	Rear light
2630A	Ground rear light
2633	Number plate light
2633A	Ground number plate light
8235	Starter commutator
9902	Kill switch
V262	High beam light indicator
V430	Fuel level light
V824	Dash board
V824A	FI light



WIRING HARNESS

» Racing light wire harness (6845)

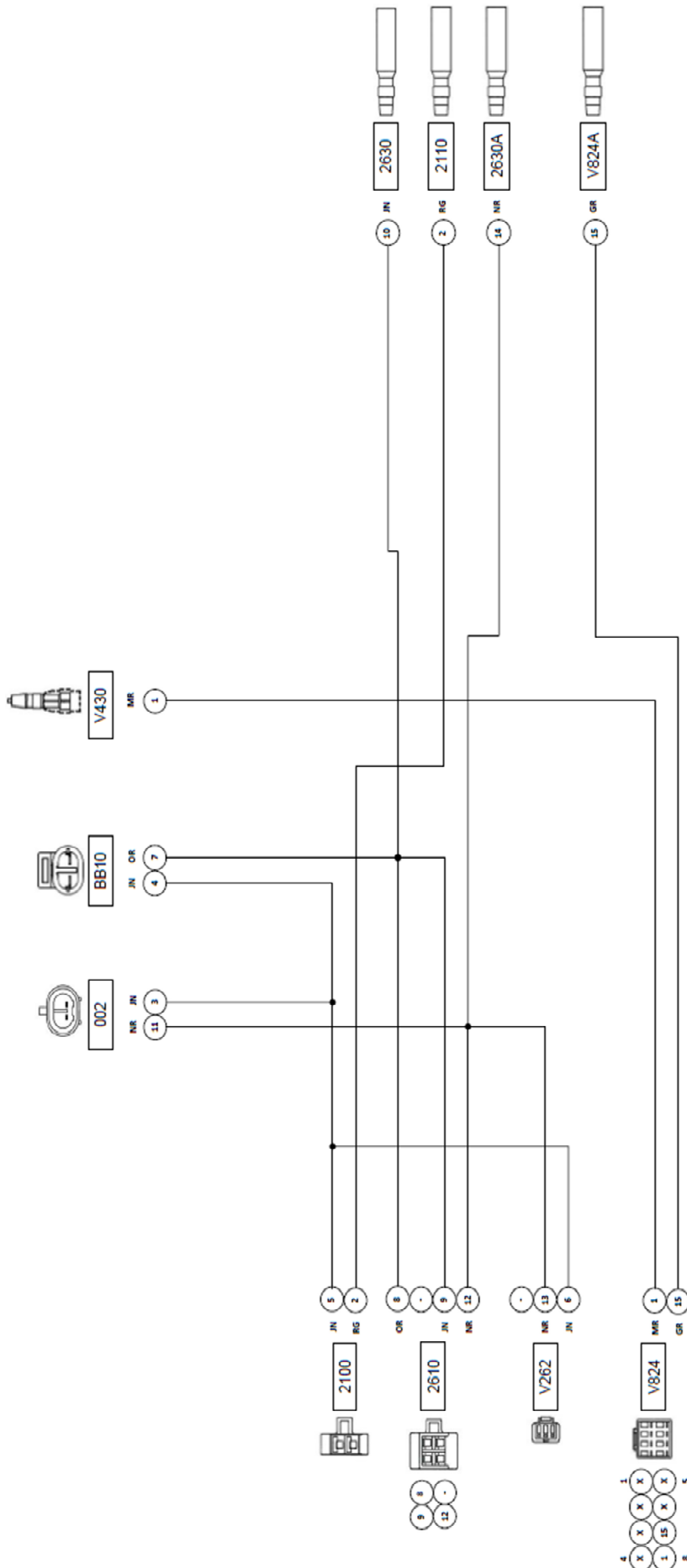

	CODE COULEUR	
	FR	GB
BA	Blanc	White
BE	Bleu	Blue
GR	GrIs	Grey
JN	Jaune	Yellow
MR	Marron	Brown
NR	Noir	Black
OR	Orange	Orange
RG	Rouge	Red
RS	Rose	Pink
VE	Vert	Green
VI	Violet	Violet
VJ	Vert/Jaune	Green/Yellow

description	
002	Main harness commutator
2100	Front brake light contactor
2110	Stop rear light
2610	Front light
2630	Rear light
2630A	Ground light
Bb10	Light switch
V262	High beam light indicator
V430	Fuel level light
V824	Dash board
V824A	FI light

WIRING HARNESS

» Main wire harness (7314)

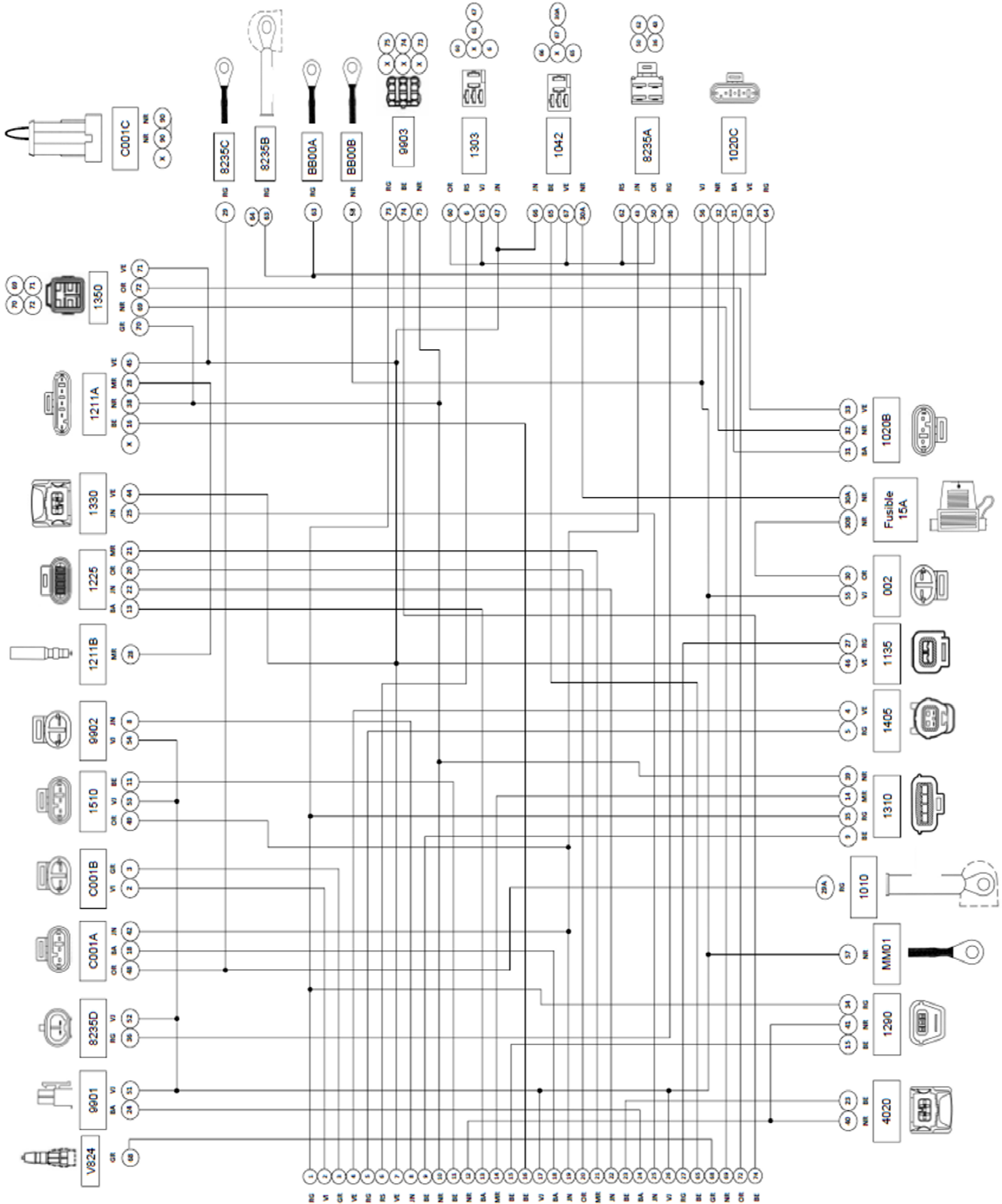

WIRING HARNESS

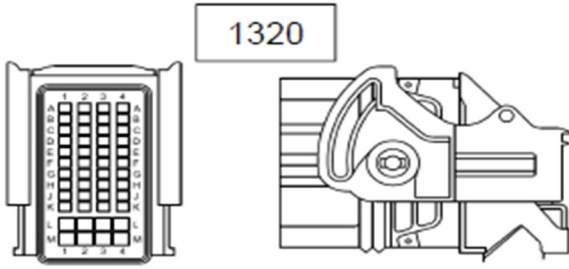

	1	2	3	4	
A	1	X	65	18	A
B	2	X	68	19	B
C	3	X	12	20	C
D	4	74	13	21	D
E	5	X	X	22	E
F	X	9	14	23	F
G	X	10	15	69	G
H	X	X	X	X	H
J	X	8	X	24	J
K	6	11	X	X	K
L	7	72	16	25	L
M	27	X	17	26	M
	1	2	3	4	

	Description
002	Light harness commutator
1010	Starter
1020B	Alternator
1020C	Regulator
1042	Light relay
1135	Ignition coil
1211A	Fuel pump
1211B	Fuel gauge
1225	Stepper
1290	TPS
1303	Ignition relay
1310	Air flow sensor
1320	ECU
1330	Injector
1350	Oxygen sensor
1405	TDC sensor
1510	Fan motor group
4020	Cooling sensor
8235A	Starter relay
8235B	Starter battery commutator
8235C	Ground starter commutator
8235D	Engine starter commutator
9901	Switch Map
9902	Kill switch
9903	Tilt Sensor
BB00A	Battery
C001A	Shunt
C001B	Diagnostic tool connector
C001C	Shunt
V824	FI light
Fusible	Fuse 15A
MM001	Ground

	CODE COULEUR	
	FR	GB
BA	Blanc	White
BE	Bleu	Blue
GR	Gris	Grey
JN	Jaune	Yellow
MR	Marron	Brown
NR	Noir	Black
OR	Orange	Orange
RG	Rouge	Red
RS	Rose	Pink
VE	Vert	Green
VI	Violet	Violet
VJ	Vert/Jaune	Green/Yellow

» Fan wire harness (3577)

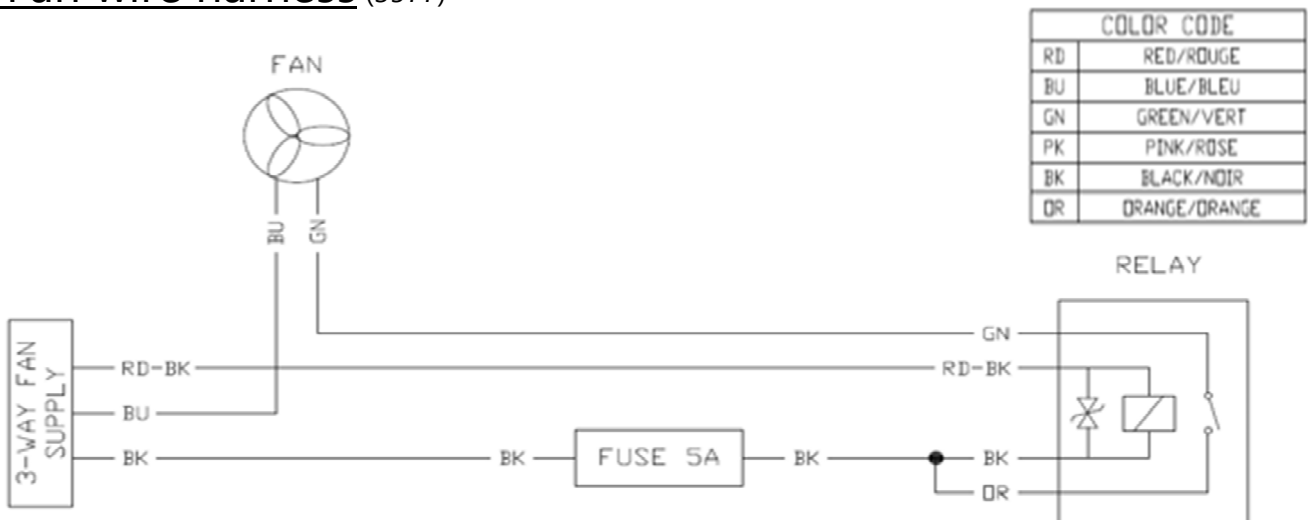

SYNERJECT INJECTION SYSTEM PRESENTATION

1.1- Injection system

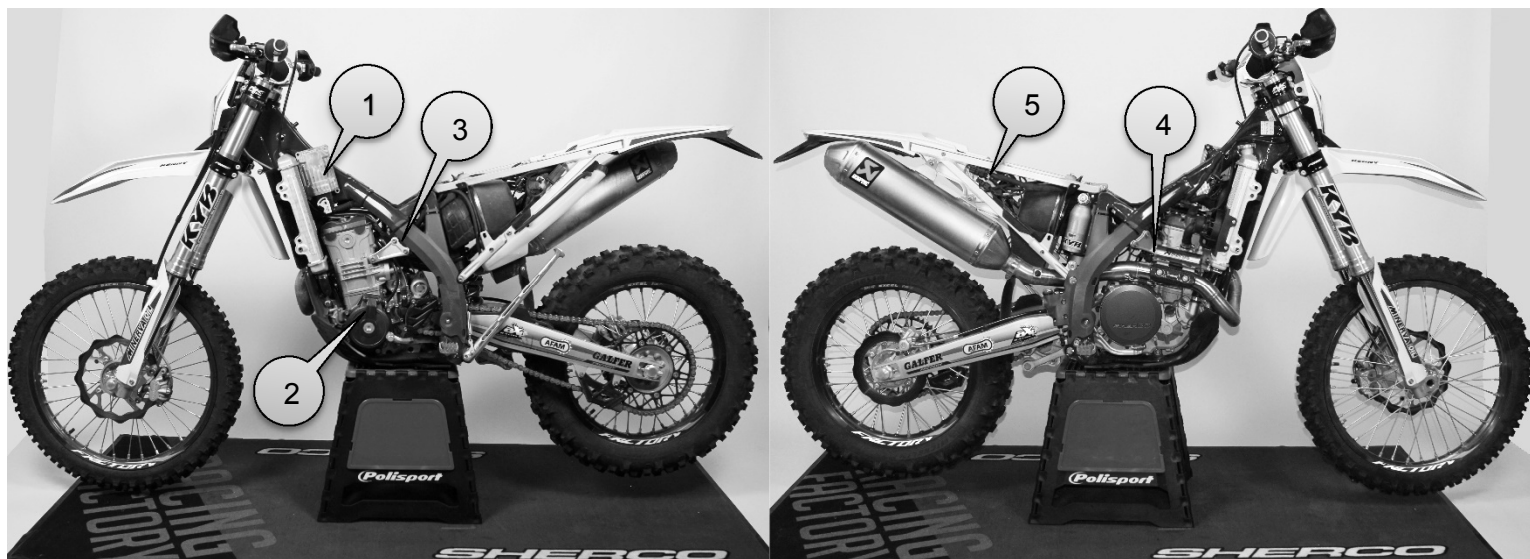

Your Sherco is equipped with a Synerject injection system that is composed of a M3C computer, a Ø 42mm throttle body, a special ignition system and a special harness.

N°	DESIGNATION	EMPLACEMENT
1	Synerject M3C Computer	Left side of the frame
2	Engine speed sensor (pick-up)	Upper part of the ignition cover
3	Synerject injection unit Ø 42mm	
4	Water temperature sensor	The rear of the cylinder head
5	Diagnostic connector with double water protection (labeled ECU)	At the right rear side panel



Picture 1 : Synerject M3C Computer

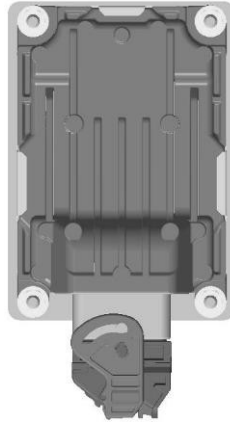

Picture 2 : Synerject injector body Ø42mm

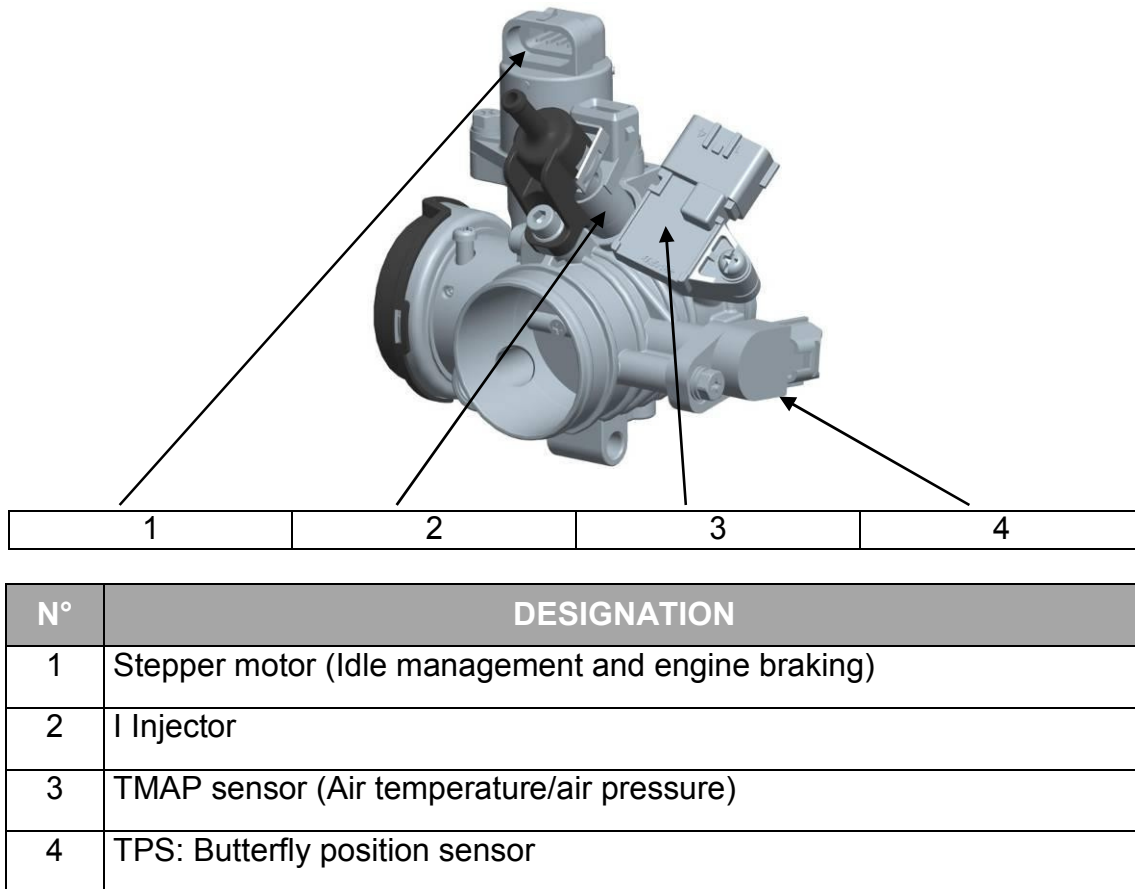

1.2- Description Exxodiag diagnostic Tools référence 4967

The diagnostic tool allows you to perform diagnostic operations, make updates to the injection mapping and to determine certain information (serial number of the motorcycle, number of hours of operation, etc.).

1.3- Diagnostic tool kit contents.

The kit consists of a USB to MUX output cable, a MUX device, a MUX to motorcycle diagnostic connector cable, an installation CD and a user manual.

1.4- Installation of the diagnostic tool

In case of problem during the installation please contact EXWOTEST at +33 (0)4 50 02 34 34 or by mail to courrierxxotest.com.

A- Installing the software and drivers

- Open the installation CD on your computer

- Run “sherco_setup”

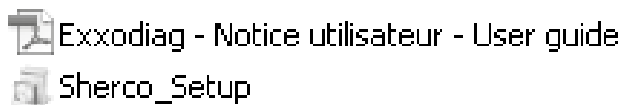

- Select the language.



- Click on « Next ».



- Choose the installation folder.

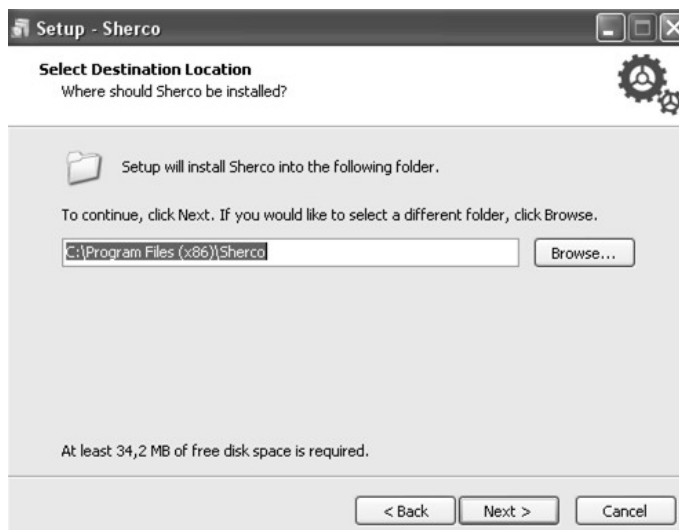

- Click on « Next ».

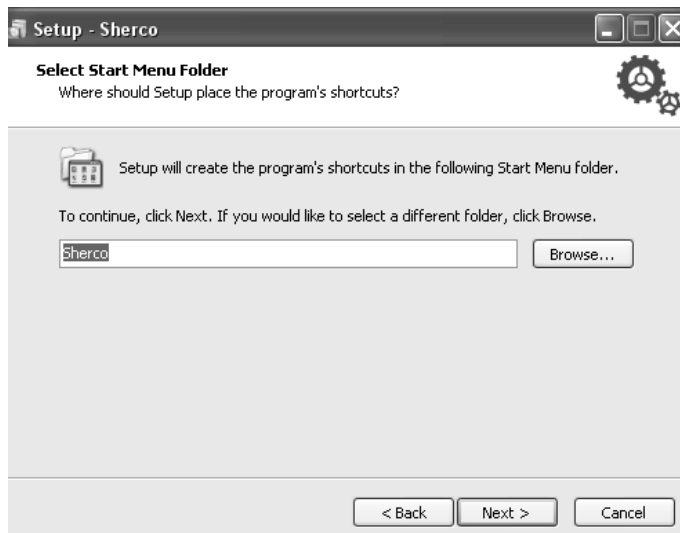

- Click on « Install ».

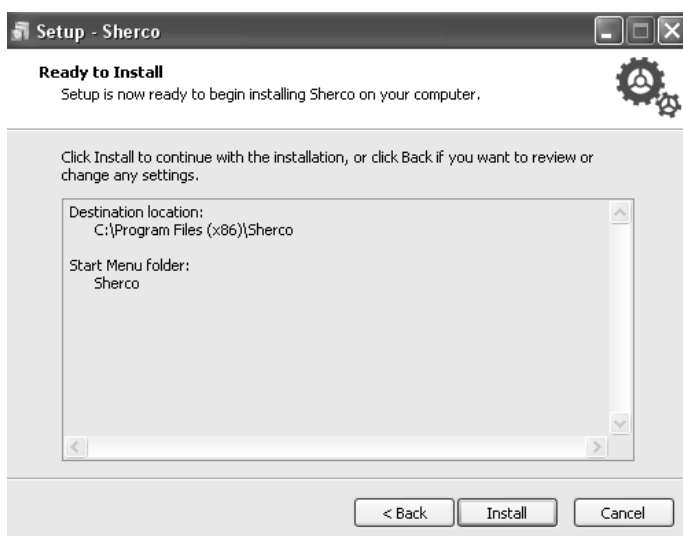

- Installation in progress.

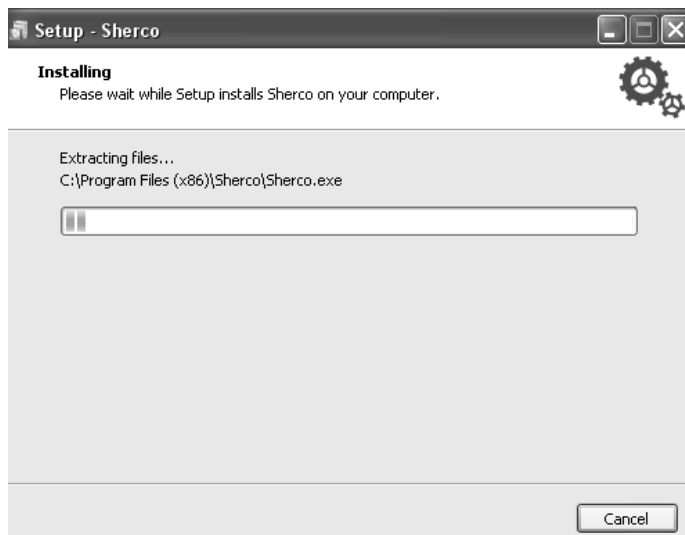

- Check the box « Start the driver installation » and click on « Finish ».



- The following window will open. Read the terms of the license agreement. Check the box « I accept the terms of the license agreement » and click on « Install ».



- Installation in progress.

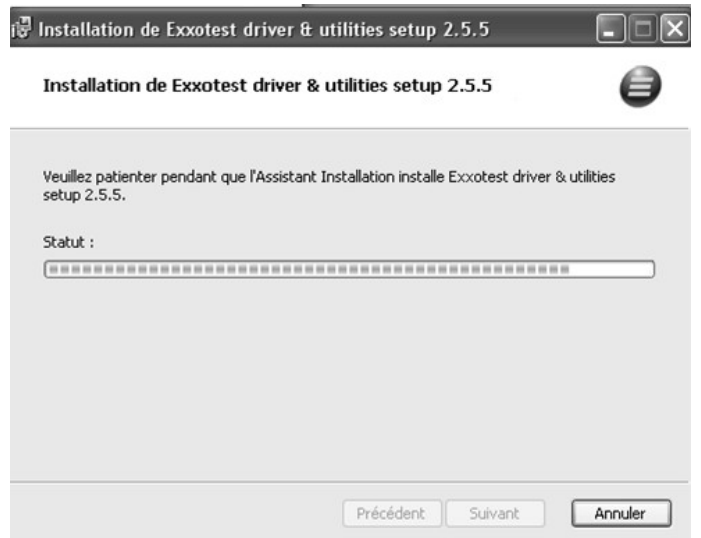

- The following window will open. Click on « Finish ».

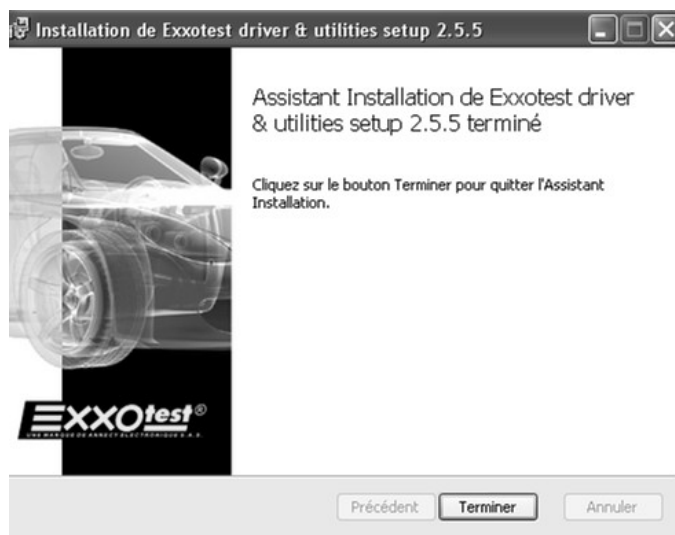

The installation is complete.

B- Connect the « MUXDIAG II » cable and its interface to a USB port on your computer

Connect the cable to the diagnostic connector of the motorcycle.

Make sure the « MUXDIAG II » unit is properly powered by checking the LED :

- Solid blue: PC connection properly established.
- Flashing blue: communication with PC in progress.
- Blue off: no connection to the PC, or device in standby; it can also indicate a problem with the USB connector.
- Solid green: firmware issue.
- Flashing green (slow): firmware correctly run.
- Flashing green (fast): communication with PC in progress.
- Green off: no firmware.
- Solid red: correct power supply to the card.

- All LEDs OFF: the outlet is not powered on, or is off or USB in on standby mode.

2.1- Connection with Keyless system

Sherco had a Keyless system on its motorcycles which allows the bike to switch on without any key and switch off automatically after 30seconds of non-use. This last point blocks the diagnostic, this is why it is necessary to follow the steps down below before doing it.

1. Remove the plug (1) from the connector (2) (located on the rear sub frame – on the right part of the bike).

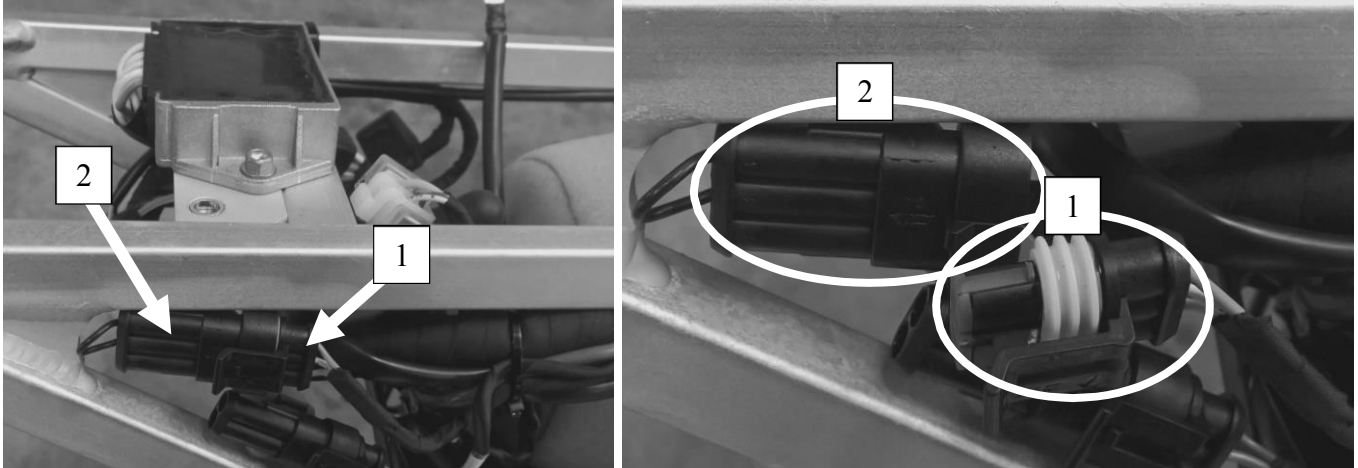

2. Take the shunt (3) (reference 6267) and connect the plug (1) into it.

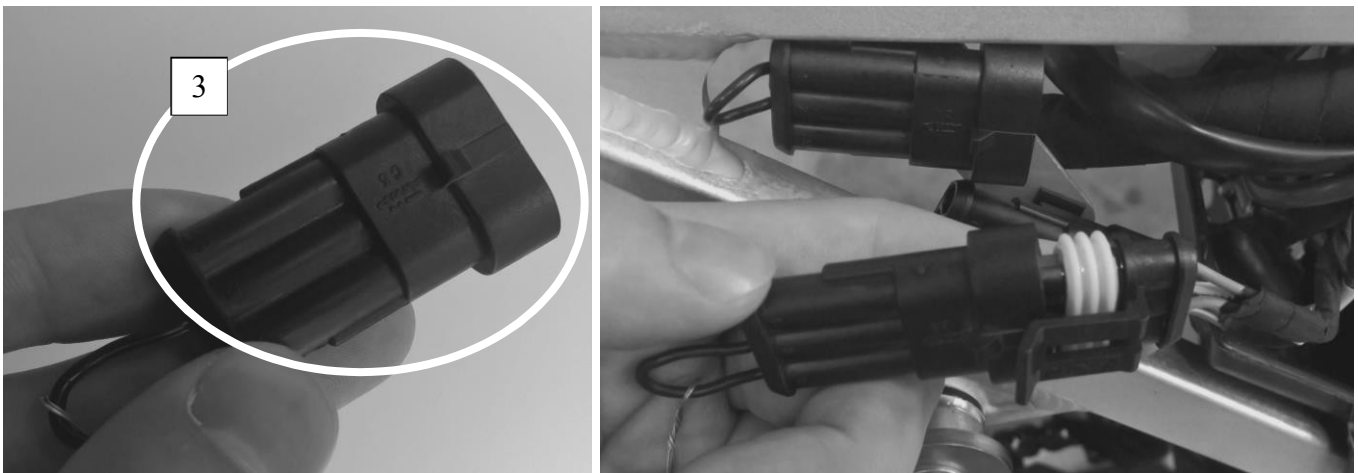

3. You can now do the diagnostic by following the next explanations.



Information : To set up the connection with the motorcycle, the motorcycle must be switched on (On). To navigate through the different menus, the USB cable with the «MUXDIAG II» device only may be connected to the computer..

Run the software using the icon



The following menu will come up :

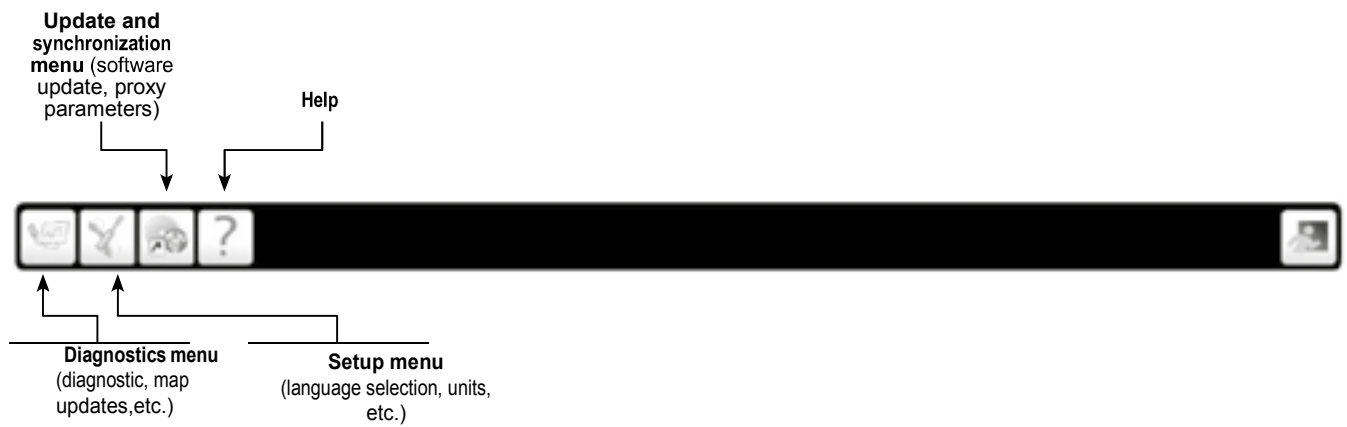

2.2 Software settings : configuration menu



In this menu, you can modify :





Configuration



- The diagnostic plug. You can refresh the list by hitting the button. The number must match the number of the « MUXDIAG II » device.
- The languages available in the software: English, French, Spanish, Portuguese, German, Italian (the installation CD provided may not include all languages). Update the software-> page 53).
- Set the unit system.



- Click  to return to the home screen.

- Click  to save the changes.



2.3- Update menu and synchronization



A- In this menu, you can update the diagnostic software tool

- To determine whether an update is available, check that you have an Internet connection, and then click on the following icon



- If an update is available, the following window will come up:



- If no update is available, the following message will come up:



- Click on  to start downloading the update.



- The following message will come up
- Click on  to start installation



- Resume the installation process -> page 41. It is not necessary to restart the installation of the drivers

B- Configuration of Internet access parameters

It may be necessary to set up a proxy server to access the Internet.

- Click on 

- Fill in the following settings if necessary.

Configuration of proxy settings

- None
- Use the following settings

Customized settings

Address / Port	<input type="text"/>	<input type="text"/>
User	<input type="text"/>	
Password	<input type="text"/>	

- Click on  to save your changes.



2.4- Using the software

Diagnostic menu and injection mapping update



General

- Click on « Sherco ».



- Click on « M3C ».



- You get the following menu :

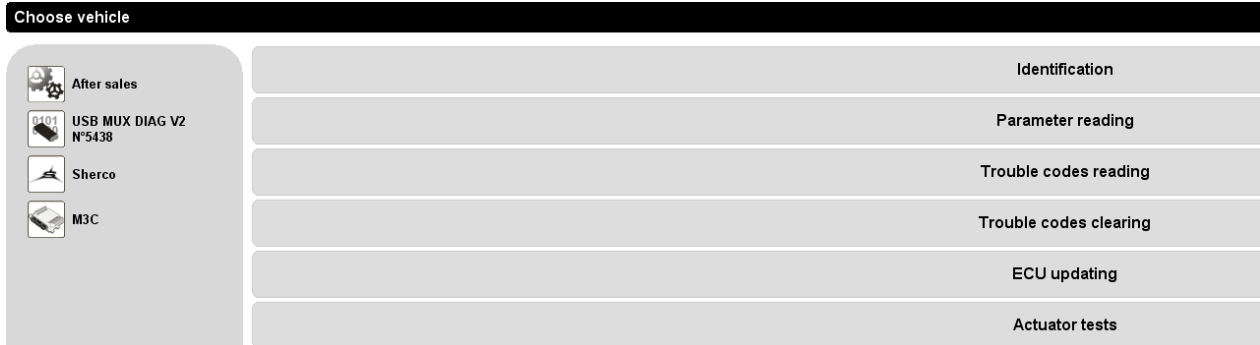

A- Identification



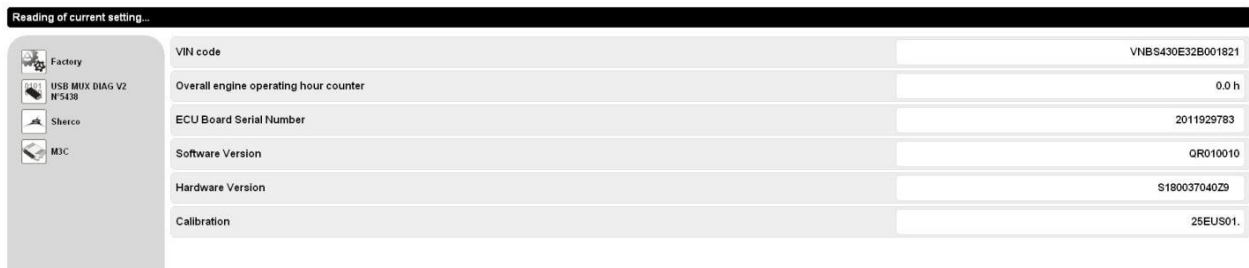

You can check the identification of the following (serial number, hours of operation, calibration number)



B- Parameter measurements

general parameters (speed, pressure, stepper, etc)





Choose category...

 After sales  USB MUX DIAG V2 N°5438  Sherco  M3C	Engine information
	Throttle Position
	Misc

1- Engine information

Displayed below are the main system values :

Reading of current setting...

 After sales  USB MUX DIAG V2 N°5453  Sherco  M3C 	RPM	0 tr/mn
	Engine Temperature	31 °C
	Battery Voltage	11.9 V
	Air temperature	28 °C
	Ambient pressure	1012 mb
	Stepper position	0
	Throttle position	0 %

Details :

- Stepper Position: The air valve (stepper) opening value -> $35 < 50 < 75$ If the value is too low: there could be an air leak at the engine air intake If the value is too high: there could be dirt in the injector butterfly area

Note : The correct air valve motor value should be 15mm and 2mm with the motor idling and at 80°C.

- Butterfly position: With the engine stopped it should be 0%: the maximum opening value should be 100%. If the value is not 0% with the engine stopped it means that it needs to be adjusted.

Perform a system reset several times (Switch the ignition off. Wait until the ECU relay shuts. Put it on the bike). The pitch should be 0.5%.

- Emergency stop button: the status of the emergency stop button. 0: off, 1: on.

- Engine status: ES (engine ready to start), ST (engine running), IS (engine is at idle), PL (acceleration), PU (deceleration), PUC (injection cutoff deceleration)



2- Other less frequently used values appear in the windows

Throttle position :

- The adjustment value for the minimum throttle butterfly opening should be (in V):
 $0.4 < 0.5V < 0.6$

Miscellaneous :

- Manifold Pressure (mb): pressure at the injector nozzle body measured by the TMAP sensor
- Engine synchronization status: engine cycle recognition. 0: engine not in phase.
1: engine running in phase.
- The full engine idling adaptation (%): not activated function

C- Reading the default codes

When you click on "read default codes" the system starts checking.

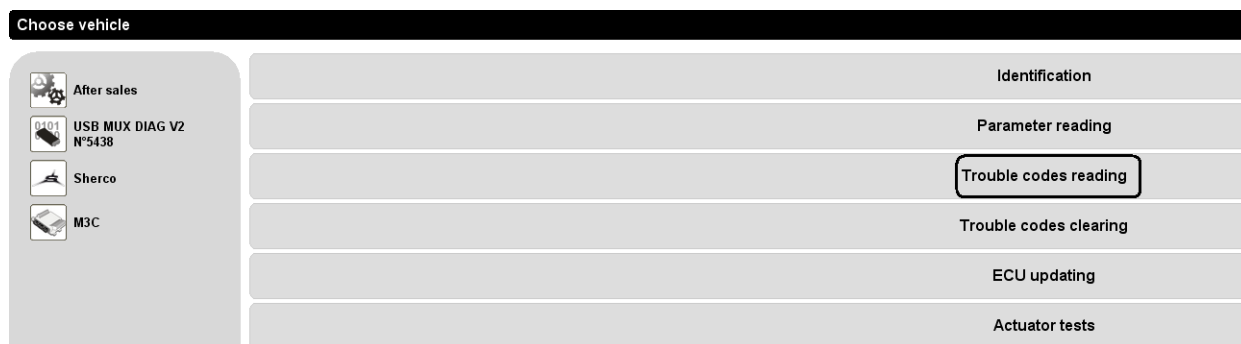





If no default appears exit the menu by clicking on this icon

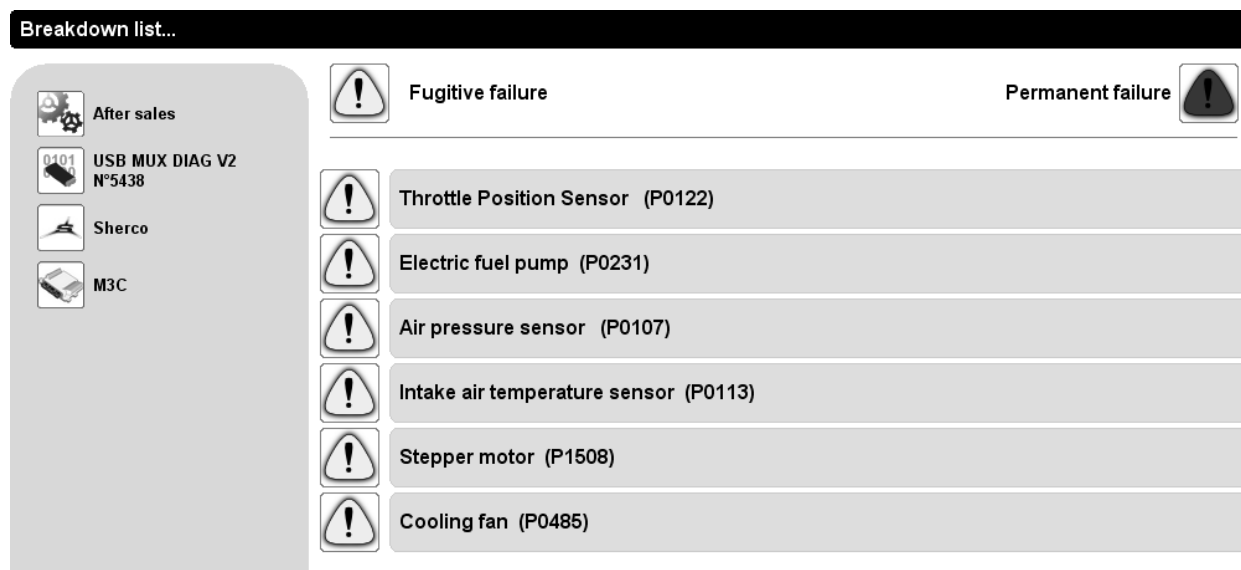

If a default appears :



Details of breakdown code...

-  After sales
-  USB MUX DIAG V2
N°5438
-  Sherco
-  M3C



Throttle Position Sensor (P0122)

Short circuit to ground or overload

- Number of occurrence of present failure = 59
- RPM = 0 tr/min
- Engine Temperature = -40 °C
- Battery voltage = 4,0 V
- Air Temperature = 29 °C
- Ambient pressure = 64 mb
- Applied Ignition angle = -29 °CRK
- Injection Time = 35 ms
- Engine state = ES
- Overall engine operating counter = 0 h
- Engine operating minute counter since last engine start = 237 min
- Throttle Position in degrees = 0 °TPS
- Intake manifold air pressure = 1360 mb
- Mass air flow = 40 mg/tdc
- Adaptive value of integral term of the idle speed controller = -50.00 %

You can get the details of the default by clicking on the default display :
Record the defaults and exit the menu by clicking on this icon



Note :

- 1- Transient default/permanent default : a transient default becomes permanent after a certain number of engine cycles of the following components (injector, fuel pump, etc). For a permanent default to disappear it takes 40 cycles without the engine default reappearing.
- 2- Fan Default : If there is no fan installed on the bike, there will always be a rise in the fan default code (P0485)

D- Erasing default codes

- 1- If a default appears : go to the menu « Erasing default codes »

Choose vehicle

-  After sales
-  USB MUX DIAG V2
N°5438
-  Sherco
-  M3C

Identification
Parameter reading
Trouble codes reading
Trouble codes clearing
ECU updating
Actuator tests



Effacer tous les codes défauts ?

Click this icon



in order to erase all of the default codes



The following screen will appear:

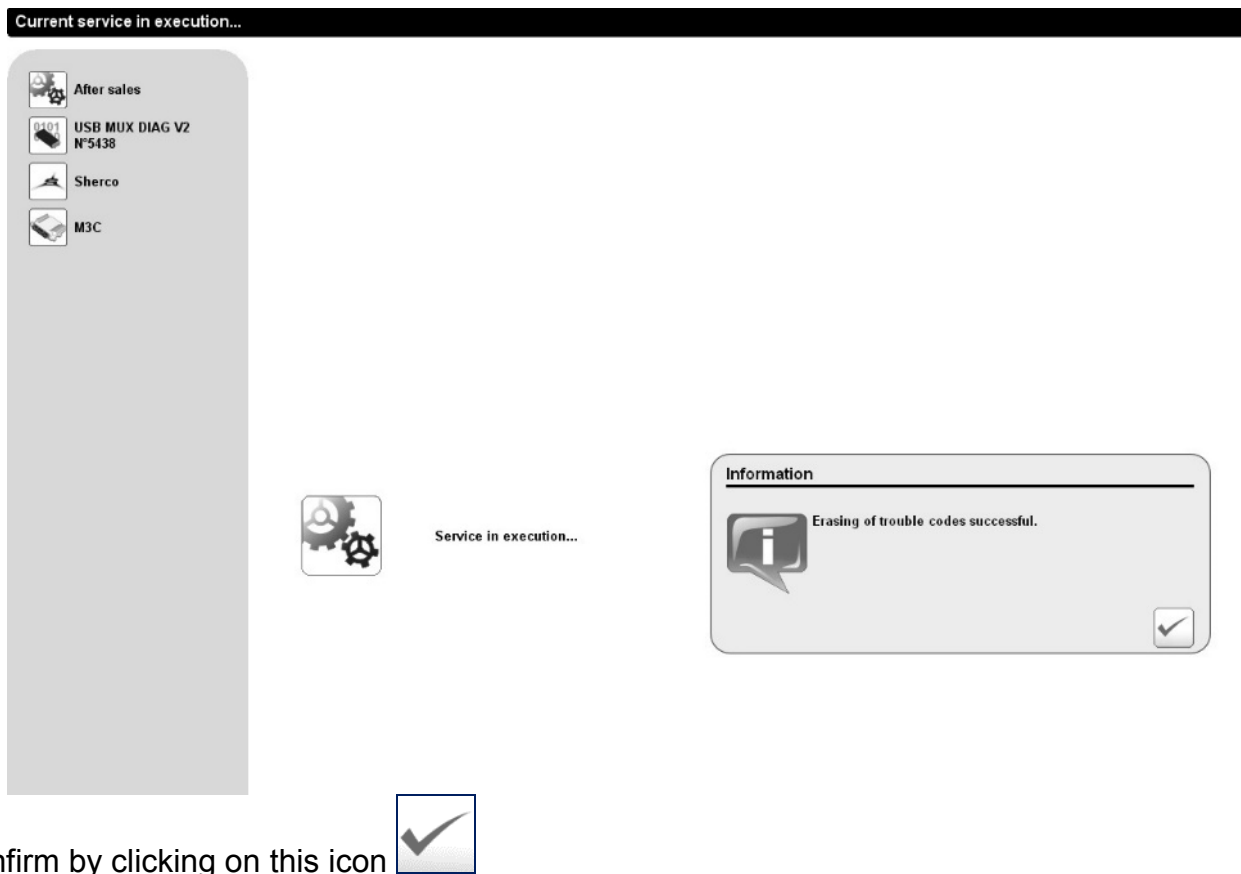

2- Return to the menu « reading default codes »

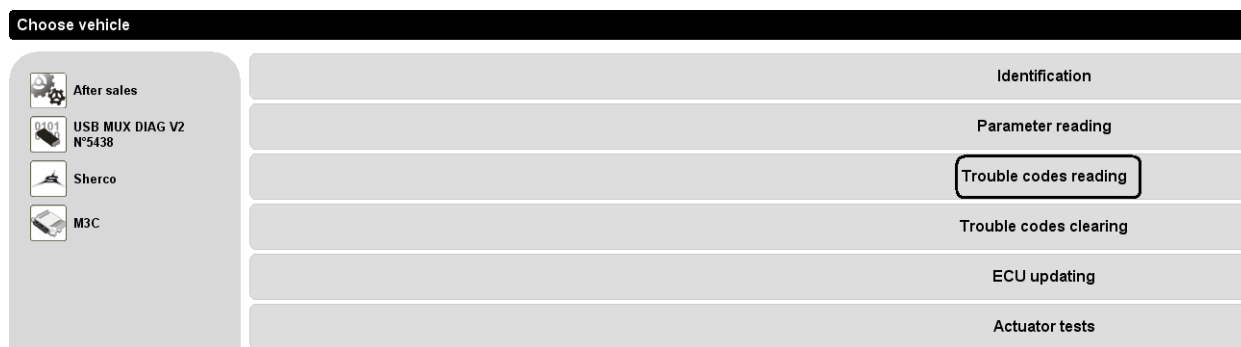

Check and make sure that the defaults are the same as before. Check/replace the defective parts. Check all of the connections.

E- Test the actuators

In addition to reading default codes you can also check some of the system components:

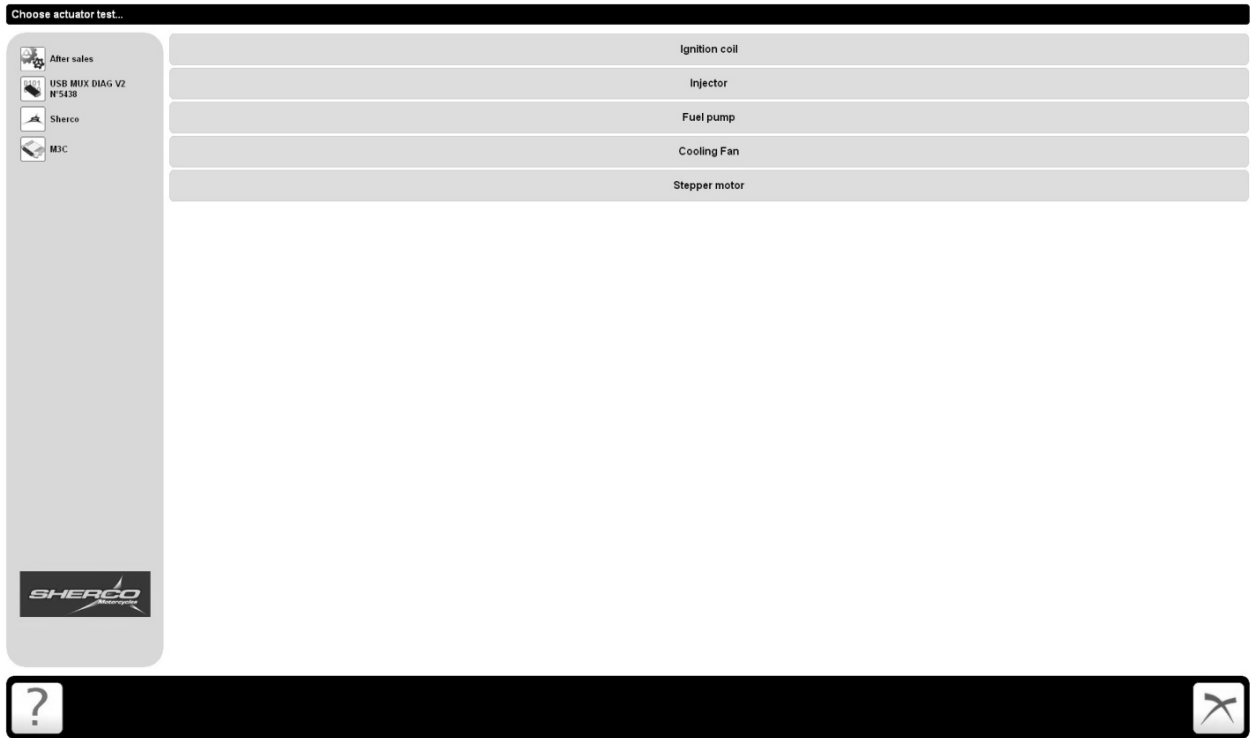

1- Ignition coil

When you launch the ignition coil test, the following message will appear :

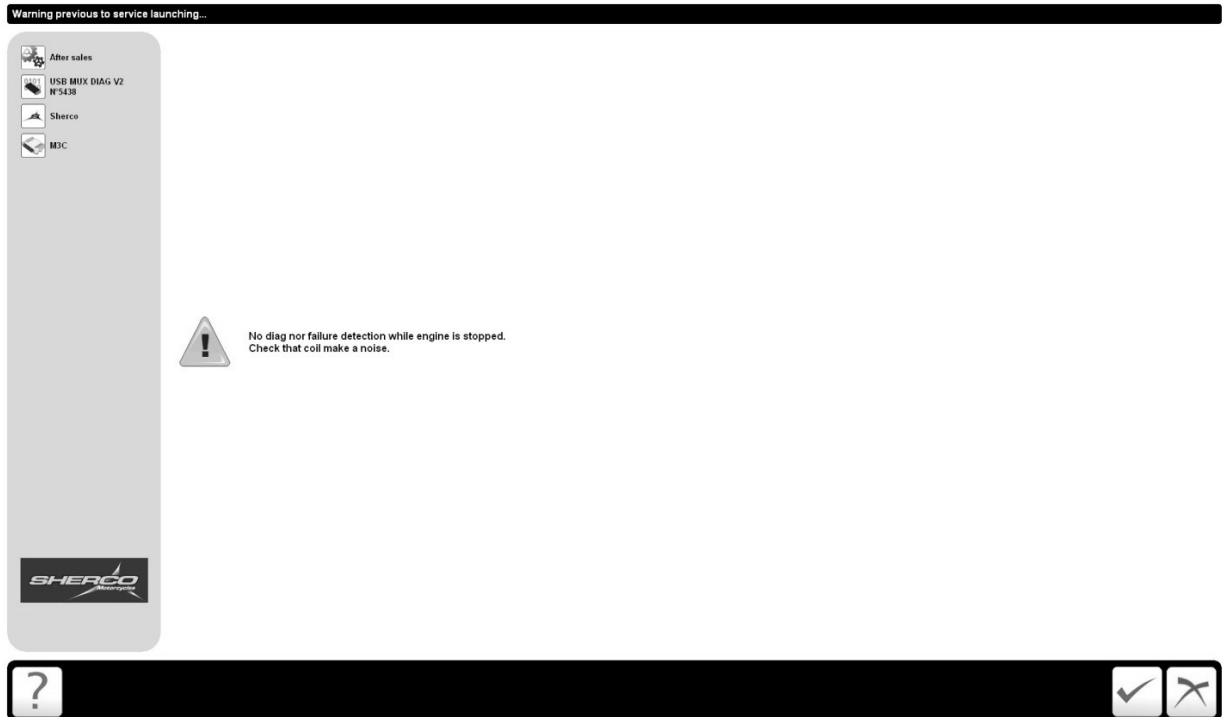

The system is not able to detect an ignition coil failure with the engine stopped. The test results will be the same if the coil is faulty or not. Therefore, when testing the ignition coil make sure that the engine makes the correct sound for a properly functioning ignition coil.





2-Injector

This is the same type of test as with ignition coil. Make sure that the injector issues a snap when activated.

3-Fuel pump / fan / stepper

For the fuel pump, the fan and the stepper (air valve) perform a standard test. If there is a default it will appear as a classic default.

Example of a functioning stepper :

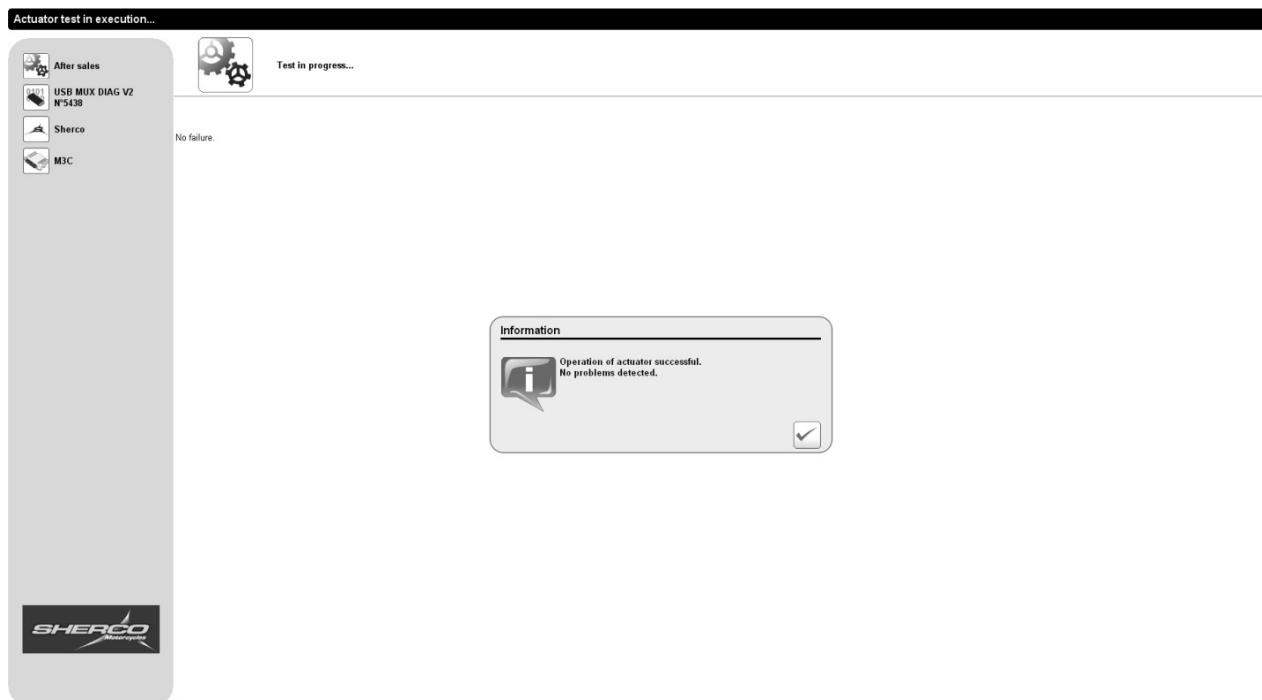

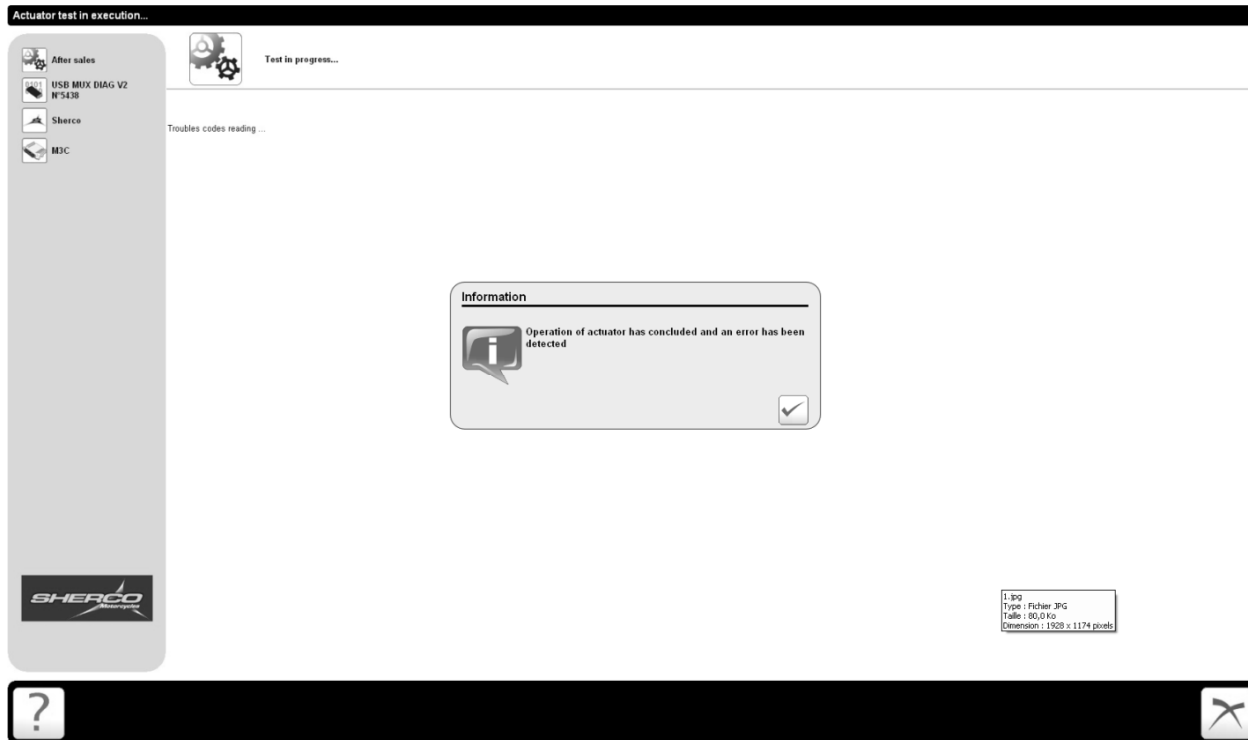

Stepper default:

In the event of a reoccurring default, check/change the defective parts.

Note : The fan test is meaningless if the bike is not equipped with a fan.

F- Updating the computer

By using the diagnostic tool it is possible to make updates to the injection mapping (calibration). An example would be the fitting of a racing silencer or there is an update from the factory. These files will be freely available on sherconetwork (end 2013):

You must pay attention to the model, the displacement, the type of silencer, etc.

In case of doubt, contact technical support.

- 1-Download the desired update (file.mot)
- 2- Power up the motorcycle
- 3- Click on the computer update

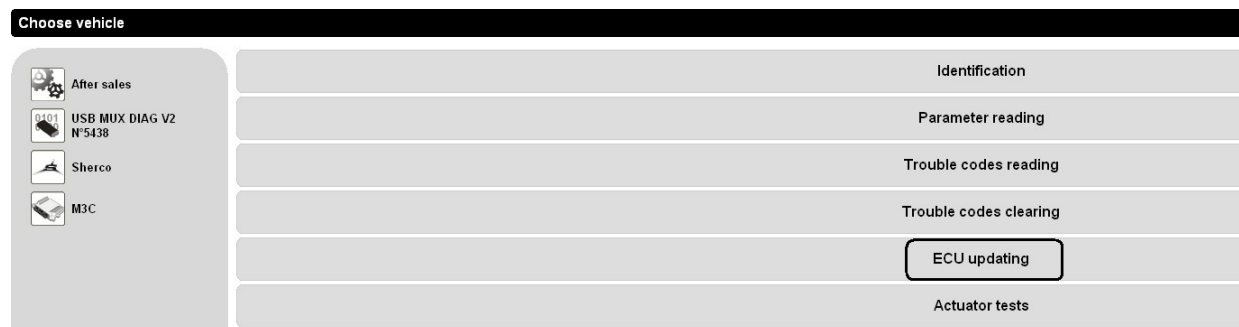



Update ECU now ?

Confirm by clicking on this icon



Select the calibration file (.mot) that was previously downloaded and click open. 4- The file is being downloaded



Downloading ... (14.2%)

WARNING !
DO NOT TURN OFF THE MOTORCYCLE DURING THE DOWNLOAD OPERATION (FLASH)
DO NOT ABRUPTLY STOP THE FLASH DOWNLOAD PROCESS
THERE IS A RISK OF IRREPAIRABLE DAMAGE TO THE COMPUTER

5- At the end of the download the fuel pump will start and the following message will appear :

INFORMATION : Download was successful

Confirm by clicking on this icon







6- Check to make sure that the correct calibration file was allocated by clicking on « Identification »

Choose vehicle

<ul style="list-style-type: none"> After sales USB MUX DIAG V2 N°5438 Sherco M3C 	<table style="width: 100%; border-collapse: collapse;"> <tr> <td style="border: 1px solid gray; padding: 2px; text-align: center;">Identification</td> </tr> <tr> <td style="border: 1px solid gray; padding: 2px; text-align: center;">Parameter reading</td> </tr> <tr> <td style="border: 1px solid gray; padding: 2px; text-align: center;">Trouble codes reading</td> </tr> <tr> <td style="border: 1px solid gray; padding: 2px; text-align: center;">Trouble codes clearing</td> </tr> <tr> <td style="border: 1px solid gray; padding: 2px; text-align: center;">ECU updating</td> </tr> <tr> <td style="border: 1px solid gray; padding: 2px; text-align: center;">Actuator tests</td> </tr> </table>	Identification	Parameter reading	Trouble codes reading	Trouble codes clearing	ECU updating	Actuator tests
Identification							
Parameter reading							
Trouble codes reading							
Trouble codes clearing							
ECU updating							
Actuator tests							

Check to make sure that the file name matches the file that was download

Lecture des paramètres en cours...

 Usine  USB MUX DIAG V2 N°5453  Sherco  M3C 	Numéro de série du véhicule (VIN)	BS630E3DB003296
	Compteur temps d'utilisation moteur	0.0 h
	N° de série du calculateur	2011980210
	Version logicielle	QR010010
	Version matérielle	S180037040Z9
Calibration	25EUS01.	

Note: Serial number information and operating hours are not reset during a calibration update.





7- Start the motorcycle and make sure that the engine parameters are normal (idle, stepper opening, etc).

G- Screen printing function

If you are communicating with technical support and need help identifying potential problems you can perform a screen print operation by pressing F10 on your keyboard. This will allow you to attach these files to your inquiry.

The "identification" screen contains all of the important information about the motorcycle (serial number of the bike, number of hours of operation, calibration, etc).

Reading of current setting...

 Factory  USB MUX DIAG V2 N°5438  Sherco  M3C 	VIN code	VNBS430E32B001821
	Overall engine operating hour counter	0.0 h
	ECU Board Serial Number	2011929783
	Software Version	QR010010
	Hardware Version	S180037040Z9
	Calibration	25EUS01.

Navigation icons: ? (left), X (right)



WWW.SHERCO.COM



SHERCO