

GALFER **MOTO**

Since 1952



CATALOGUE 2020 - 2021

**GENERAL APPLICATIONS · APLICACIONES GENERALES**

APPLICAZIONI GENERALI · APPLICATIONS GÉNÉRAL

33**BRAKE PADS · PASTILLAS DE FRENO**

PASTIGLIE DI FRENO · PLAQUETTES DE FREIN

117**BRAKE DISCS · DISCOS DE FRENO**

DISCHI FRENO · DISQUES DE FREIN

209**BRAKE SHOES · MORDAZAS DE FRENO**

GANASCE FRENO · MÂCHOIRES DE FREIN

261**BRAKE LINES & FITTINGS · LATIGUILLOS DE FRENO Y RACORERÍA**

TUBI FRENO E RACCORDI · DURITES DE FREIN ET RACCORD

267**BRACKETS OVERSIZED DF · SOPORTES DF SOBREMEDIDA**

SUPPORTI DF MAGGIORATI · SUPPORTS DF OVERSIZE

283**BRAKE KITS · KITS DE FRENO**

KITS FRENO · KITS DE FREIN

289**PADS CROSS REFERENCES · CRUCE DE REFERENCIAS PASTILLAS**

COMPARATIVA PASTIGLE · CORRESPONDANCE PLAQUETTES

303



 Industrias Galfer is a leading manufacturer of friction materials and components for braking systems for the automobile, motorcycling, and bicycle sectors. Since our company was founded in 1952, we have been known for being at the forefront of innovation, quality and organization. Today we link our experience and tradition to new technologies, cutting-edge materials and the most advanced management systems. To stay at the forefront of the market and to get to know in depth the needs for the industry, the R&D department at GALFER works closely with top-level competition teams. All our products are strictly tested for quality to guarantee its safety. We are so committed with quality regulations that our quality controls exceed the ECE R-90 standards. GALFER business philosophy is based on the values that led us to become a world leader in braking systems. There's only a thing that our brakes cannot stop: the speed at which we enter the future.

 Industrias Galfer es una empresa líder en la fabricación de materiales de fricción y componentes de sistemas de frenado para los sectores de automoción, motociclismo y bicicleta. Desde nuestra fundación, en 1952, hemos destacado por estar en primera línea en cuestiones de innovación, calidad y organización. Hoy nuestra experiencia y tradición se unen a las nuevas tecnologías, los materiales de última generación y los sistemas de gestión más novedosos. Para estar a la vanguardia del mercado y conocer en profundidad las necesidades del sector, el departamento de I+D+i de GALFER trabaja en estrecha colaboración con diversos equipos de alta competición mundial. Todos nuestros productos se someten a un estricto control de calidad que garantiza su seguridad. Nuestro compromiso con la legislación en materias de calidad es tal que nuestros controles superan los estándares de la directiva ECE R-90 vigente. El espíritu empresarial de GALFER se fundamenta en la apuesta por los valores que nos han llevado a consolidarnos como el referente internacional en sistemas de frenado. Lo único que nuestros sistemas no pueden frenar es la velocidad con que nos adentramos en el futuro.

 Industrias Galfer é stata fondata nel 1952 da Maffio Milesi. Trascorso piú di mezzo secolo GALFER si é consolidata come uno dei principali produttori di materiale d'attrito, freni, per il settore automobilistico e motociclistico. Tradizione, esperienza nel settore ricambi, investimenti continui in R&D, macchinari di ultima generazione, alta tecnologia e marcata tendenza per l'innovazione ci collocano fra le Imprese leader nel settore, con uno standard qualitativo che ci consente di essere stati scelti da molti produttori di veicoli come partner per lo sviluppo e fornitori. Attivi nel campo agonistico, ci possiamo vantare sia nelle 4 quanto nelle 2 ruote di aver contribuito ad ottenere vari campionati mondiali: Velocità, SBK, MX, SX, EC, Trial, Supermotard.

 Industrias Galfer a été fondée en 1952 par Maffio Milesi. Plus d'un demi-siècle s'est écoulé depuis et Galfer est aujourd'hui devenu l'un des principaux fabricants de matériel de friction et de système de freinage du secteur deux roues et automobile. Notre expérience, renforcée par notre investissement continu en recherche et développement, nos machines de dernière génération, nos technologies de pointe font de Galfer une des sociétés leader du secteur. Notre extrême exigence pour la qualité nous permet d'équiper les véhicules des principaux fabricants mondiaux et de soutenir de nombreux pilotes pour l'obtention de titres mondiaux: Championnat du Monde de vitesse, SBK, MX, SX, EC, Trial, Supermotard.





1952



1990





1992





2009



 The R+D+i department is key to the evolution of each of our products. Each piece is submitted to strict quality controls that guaranty the highest safety and performances. Considering the current market trends, Industrias Galfer is moving its current management system ISO 9001 to the new IATF 16949, in order to meet the requirements of the automotive sector and supply its clients more efficiently. Teamwork and collaboration with customers and suppliers is the synergy that allows us to develop new materials and techniques to improve product day after day. As a result, we have achieved great advances that result in patents and remarkable innovations. Our products are approved by the TÜV (KBA 60811 - 61147 - 61148 - 61197). The brake discs "Disc Wave®" is an example of our drive to innovate: product led to excellence that offers the end user a technology taken from the high competition.

 El Departamento de I+D+i es clave en la evolución de cada uno de nuestros productos. Cada pieza se somete a un estricto control de calidad que garantiza su máxima seguridad y prestaciones. Dadas las actuales tendencias del mercado, Industrias Galfer está migrando su actual sistema de gestión ISO 9001 al sistema IATF 16949, con el objeto de poder asumir las exigencias del sector de la automoción y poder suplir de forma óptima las necesidades de nuestros clientes. El trabajo en equipo y la estrecha colaboración con clientes y proveedores es la sinergia que nos permite desarrollar nuevos materiales y técnicas capaces de mejorar el producto día a día. Gracias a ello, hemos conseguido grandes avances que se traducen en patentes e innovaciones destacables. Nuestros productos están homologados por la certificación TÜV (KBA 60811 - 61147 - 61148 - 61197). El disco de freno "Disc Wave®" es un ejemplo de nuestro afán innovador: un producto llevado a la excelencia que ofrece al usuario final una tecnología de la alta competición.

 Le nostre attività di R & S sono la chiave per l'evoluzione dei nostri prodotti. Ogni pezzo viene sottoposto a severi controlli di qualità e garantisce la massima sicurezza e prestazioni. Nell'intento di seguire la tendenza del mercato, Galfer è migliorare il suo attuale sistema qualitativo gestionale ISO 9001 passando al sistema IATF 16949, obiettivo è di supplire a tutte le esigenze del settore automazione far fronte a tutte le necessità dei propri clienti. Il lavoro di squadra e la stretta collaborazione con i fornitori e clienti è la sinergia che ci permette di sviluppare nuovi materiali e nuove tecniche per migliorare il prodotto ogni giorno. Come risultato, abbiamo fatto grandi progressi che si traducono in brevetti con notevoli evoluzioni. I nostri prodotti sono approvati dal TÜV (KBA 60811 - 61147 - 61148 - 61197). I dischi freno "Disc Wave®" sono un esempio della nostra volontà di innovare: un prodotto di eccellenza e alta tecnologia rivolto all'utente finale.

 Notre département d'engineering joue un rôle clé dans l'évolution de chacun de nos produits. Chaque pièce est soumise à un contrôle qualité strict qui garantit une sécurité et des performances optimales. Compte tenu des tendances actuelles du marché, Industrias Galfer a changé son système actuel de gestion ISO 9001 vers un système IATF 16949 afin de pouvoir satisfaire les exigences du secteur automobile et approvisionner de façon optimale ses clients. Notre travail d'équipe et une collaboration continue avec nos clients et fournisseurs crée une synergie qui nous permet de développer de nouveaux matériaux et des techniques capables d'améliorer nos produits jours après jours. Grâce à cela, nous avons réalisé de grands progrès qui se traduisent par des brevets et de remarquables innovations. Nos produits sont approuvés par le TÜV (KBA 60811 - 61147 - 61148 - 61197). Le disque de frein "Disc Wave®" est un exemple de notre volonté d'innover: un produit gage d'excellence qui offre à l'utilisateur final une technologie de compétition.



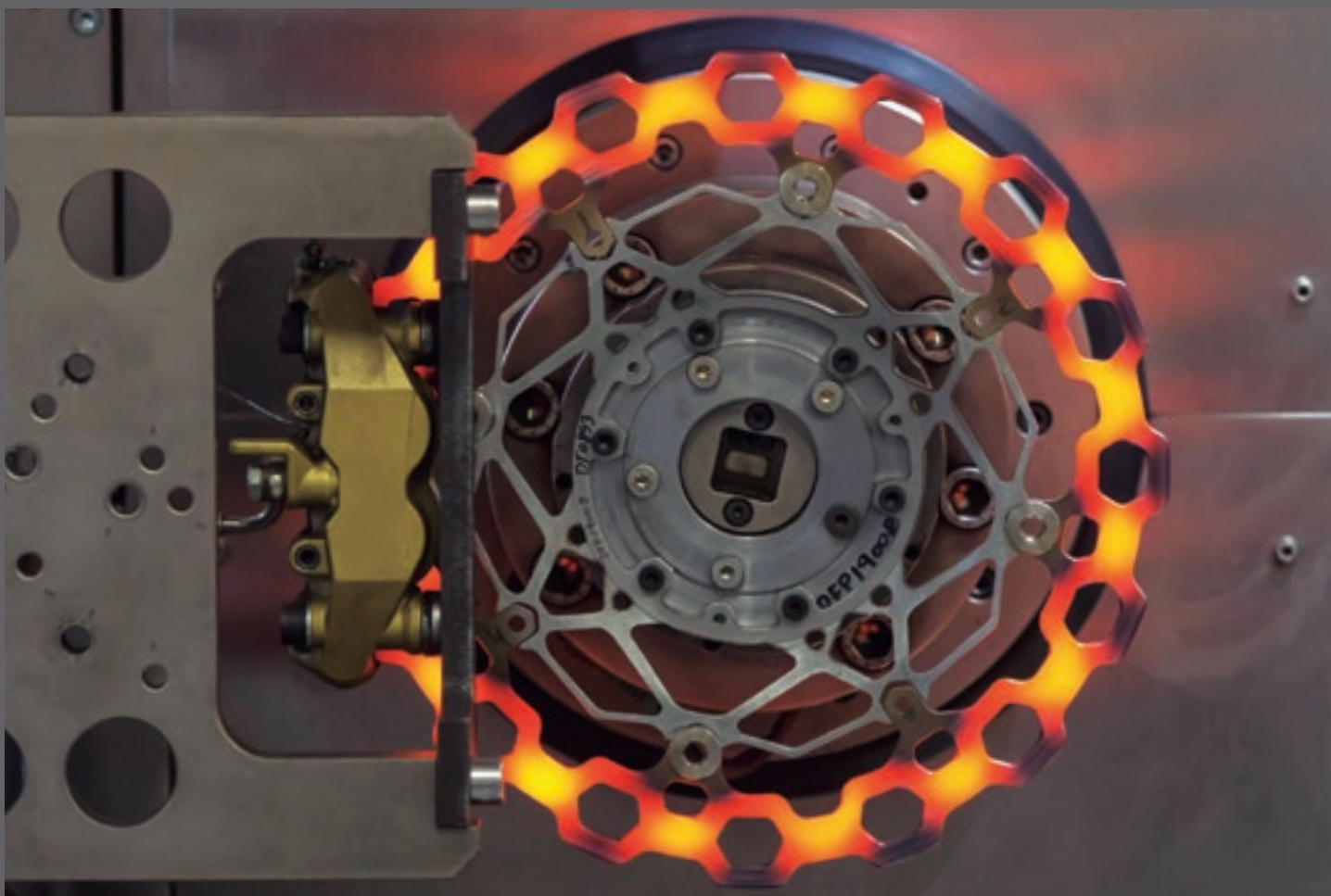

 Our products have been certified by TÜV (KBA 60811 - 61147 - 61148 - 61197) & ECE R90 and the most demanding product standards:

- ABE 60811: Brake pads, Typ 1054
- ABE 61147: Fixed brake discs DISC WAVE®, Typ W
- ABE 61148: Floating brake discs DISC WAVE®, Typ FLW
- ABE 61197: Brake pads, Typ 1375
- ECE R90 R90: Brake pads, all compounds.

Our quality assurance system reflects our experience after all these years supplying friction materials to the leading automobiles and motorbikes manufacturers.

 Nuestros productos están homologados por la certificación TÜV (KBA 60811 - 61147 - 61148 - 61197) y ECE R90 con las homologaciones de producto más exigentes:

- ABE 60811: Pastillas de freno de disco, Typ 1054
- ABE 61147: Discos de freno DISC WAVE® fijos de recambio, Typ W
- ABE 61148: Discos de freno DISC WAVE® flotantes de recambio, Typ FLW
- ABE 61197: Pastillas de freno de disco, Typ 1375
- ECE R90: Pastillas de freno, todos los compuestos.

Nuestro sistema de garantía de calidad es un reflejo de la experiencia ganada con los años de suministro de materiales de fricción a los principales fabricantes de automóviles y motos.

 I nostri prodotti sono certificati dall'ente TÜV (KBA 60811 - 61147 - 61148 - 61197) e ECE R90 da i piu esigenti enti di certificazione di prodotto:

- ABE 60811: Pastiglie freni disco, Typ 1054
- ABE 61147: Dischi freno DISC WAVE® fissi ricambio, Typ W
- ABE 61148: Dischi freno DISC WAVE® flottanti ricambio, Typ FLW
- ABE 61197: Pastiglie freni disco, Typ 1375
- ECE R90: Pastiglie freno, tutti i mescola.

Il nostro sistema di garanzia di qualità riflette la nostra esperienza acquisita nel corso degli anni in cui abbiamo fornito materiali di attrito alle piu importanti case automobilistiche e motociclistiche.

 Nos produits sont certifiés par TÜV (KBA 60811 - 61147 - 61148 - 61197) et ECE R90 sont conformes aux normes les plus exigeantes:

- ABE 60811: plaquettes de frein à disque, Type 1054
- ABE 61147: disques de frein à étrier fixe DISC WAVE®, Type W
- ABE 61148: disques de frein à étrier flottant DISC WAVE®, Type FLW
- ABE 61197: plaquettes de frein à disque, Type 1375
- ECE R90: plaquettes de frein, tous les composés.

Notre qualité de produit est le fruit de notre longue expérience en tant que fournisseur de matériel de fiction pour les principaux fabricants d'automobiles et de motos.



 - **MISSION:** To offer friction materials and components for comprehensive brake system solutions.
 - **VISION:** To become an international benchmark for braking systems.
 - **VALUES: INNOVATION:** Continual introduction of new technologies to offer improved products to the market.
ASSURANCE: Offering solutions fitted to our clients needs and to complying with current laws in all our activities, as well as any other agreed requirements related to the management system.
CONFIDENCE: By means of innovation and implementation of a quality management system based on continual improvement.
EFFICIENCY: Encouraging teamwork and facilitating direct and customized attention to our clients and complying with all our products specifications.
SUSTAINABILITY: Respecting the environment and minimizing the environmental impact.
SAFETY: Investing and training to guarantee the maximum safety and occupational health.
ACCOUNTABILITY: Ethical and responsible management in all our activities.

 - **MISIÓN:** Ofrecer materiales de fricción y componentes para soluciones integrales de sistemas de frenado.
 - **VISIÓN:** Convertirnos en un referente internacional en sistemas de frenado.
 - **VALORES: INNOVACIÓN:** incorporación constante de nuevas tecnologías para aportar mejoras de productos al mercado.
GARANTÍA: ofrecer soluciones ajustadas a los requisitos de nuestros clientes y cumplir con la legislación vigente en todas nuestras actividades, así como otros requisitos suscritos relacionados con el sistema de gestión.
CONFIANZA: mediante la innovación y la implantación de un sistema de gestión de calidad basado en la mejora continua que garantiza los resultados esperados.
EFICACIA EN LA GESTIÓN: fomentando el trabajo en equipo y facilitando un trato directo y personalizado a nuestros clientes y cumpliendo todas las especificaciones de nuestros productos.
SOSTENIBILIDAD: respeto al medio ambiente y minimización del impacto medio ambiental.
SEGURIDAD: inversión y formación para garantizar la máxima seguridad y salud en el trabajo.
RESPONSABILIDAD: gestión ética y responsable en todas nuestras actividades.

 - **LA NOSTRA MISSIONE:** Offrire i migliori materiali di attrito e componenti per soluzioni integrate di sistemi frenanti. L
 - **A NOSTRA VISIONE:** Diventare leader internazionale dei sistemi frenanti.
 - **I NOSTRI VALORI: INNOVAZIONE:** Adottare nuove tecnologie per sviluppare e migliorare i prodotti sul mercato.
GARANZIA: Offrire soluzioni adatte alle esigenze dei nostri clienti e rispettare la normativa vigente in tutte le nostre attività, nonché gli altri requisiti relativi al sistema di gestione.
AFFIDABILITÀ: Garantire i risultati attraverso l'innovazione e l'implementazione di un sistema di gestione della qualità basato sul miglioramento continuo.
GESTIONE EFFICACE: Favorire il lavoro di squadra, procurare un'attenzione diretta e personalizzata ai nostri clienti e compiere tutte le specifiche dei nostri prodotti.
SOSTENIBILITÀ: Rispettare l'ambiente e cercare di minimizzare l'impatto ambientale.
SICUREZZA: Investire in formazione per garantire la massima sicurezza e la salute nel luogo di lavoro.
RESPONSABILITÀ: Essere etici e responsabili in tutte le nostre attività.

 - **MISSION:** fournir des matériaux de friction et des composants destinés à des solutions complètes de systèmes de freinage.
 - **PERSPECTIVE:** devenir une référence internationale en matière de systèmes de freinage.
 - **VALEURS: INNOVATION:** intégrer constamment de nouvelles technologies visant à améliorer les produits disponibles sur le marché.
GARANTIE: proposer des solutions adaptées aux attentes de nos clients, respecter la législation en vigueur dans l'ensemble de nos activités et répondre à toutes les exigences de systèmes de gestion.
CONFIANCE: innover et mise en œuvre d'un système de gestion de la qualité reposant sur l'amélioration continue, garantissant l'obtention des résultats escomptés.
EFFICACITÉ DE GESTION: encourager le travail d'équipe, réserver une attention directe et personnalisée à nos clients, et respecter toutes les spécifications de nos produits.
DÉVELOPPEMENT DURABLE: respecter l'environnement et minimiser l'impact sur ce dernier.
SÉCURITÉ: investir et former pour garantir une hygiène et une sécurité maximales des conditions de travail.
RESPONSABILITÉ: gérer toutes nos activités sur la base de critères éthiques et responsables.



 All GALFER products (discs, pads and brake lines) are designed and manufactured in our 6000 sq. meters factory at Granollers (Barcelona), next to the Circuit de Catalunya.

The production process begins in the R&D Department, responsible for launching new products. The materials are developed in our laboratories and then chemical and physical tests are conducted. Once this phase is completed and to determine their going into production further tests are conducted on a vehicle. The Department of Methodology designs the production processes with the Engineering Department. Finally, the Quality Department certifies the quality and reliability of our products according to ISO standards.

We are members of the FEMFM (Federation of European Manufacturers of Friction Materials), and we have worked together for the European Quality Manual of disk pads, drum brake calipers and clutches.

 Todos los productos GALFER (discos, pastillas y latiguillos de freno) se diseñan y se producen en la fábrica de Granollers (Barcelona), unas instalaciones de 6000 m2 situadas al lado del Circuit de Catalunya.

El proceso productivo se inicia en el Departamento de I+D+i, que se encarga del lanzamiento de nuevos productos. Nuestros laboratorios desarrollan los materiales y los someten a pruebas químicas y físicas. Superada esta fase, se realizan las pruebas sobre el vehículo para determinar el paso a producción. El Departamento de Metodología diseña los procesos productivos en conjunción con el Departamento de Ingeniería. En último lugar interviene el Departamento de Control de Calidad, que certifica la calidad y fiabilidad de nuestros productos siguiendo las normas ISO.

Somos miembros de la FEMFM (Federation of European Manufacturers of Friction Materials), con la que hemos colaborado en la elaboración del Manual de Calidad europeo para pastillas de frenos de disco, mordazas de freno de tambor y embragues.

 Tutti i prodotti GALFER (dischi, pastiglie e tubi freno) sono progettati e prodotti nella fabbrica di Granollers (Barcellona), i cui stabilimenti occupano una superficie di 6000 m2 accanto al Circuit de Catalunya.

Il processo produttivo ha inizio nel reparto di R+S+i, responsabile del lancio di nuovi prodotti. I nostri laboratori sviluppano quindi i materiali e li sottopongono a test chimici e fisici. Superata questa fase, si eseguono prove sul veicolo per determinare se il prodotto possa entrare nella fase di produzione. Il reparto di metodologia sviluppa i processi produttivi in collaborazione con il reparto ingegneria e, infine, interviene il reparto di Controllo qualità, che certifica, appunto, la qualità e l'affidabilità dei nostri prodotti conformemente alle norme ISO.

Siamo membri della FEMFM (Federation of European Manufacturers of Friction Materials), con cui abbiamo collaborato alla redazione del Manuale di qualità europeo delle pastiglie per freni a disco, ganasce per freni a tamburo e frizioni.

 L'ensemble des produits GALFER (disques, plaquettes et câbles de frein) sont conçus et produits dans l'usine de Granollers (Barcelone), dans des installations d'une superficie de 6 000 m² implantées près du circuit de Barcelone-Catalogne.

Le processus de production débute au département R&D et innovation en charge du lancement des nouveaux produits. Nos laboratoires développent les matériaux et les soumettent à des essais chimiques et physiques. Une fois cette phase terminée, les essais sont réalisés sur le véhicule afin de déterminer le passage à la production. Le département Méthodologie conçoit les processus de production conjointement avec le département Ingénierie. Le département Contrôle qualité intervient en dernier lieu afin de certifier la qualité et la fiabilité de nos produits, dans le respect des normes ISO. Nous sommes membres de la FEMFM (Federation of European Manufacturers of Friction Materials) avec laquelle nous avons collaboré pour l'élaboration du Manuel qualité européen concernant les plaquettes de frein à disque, les étriers de frein à tambour et les embrayages.

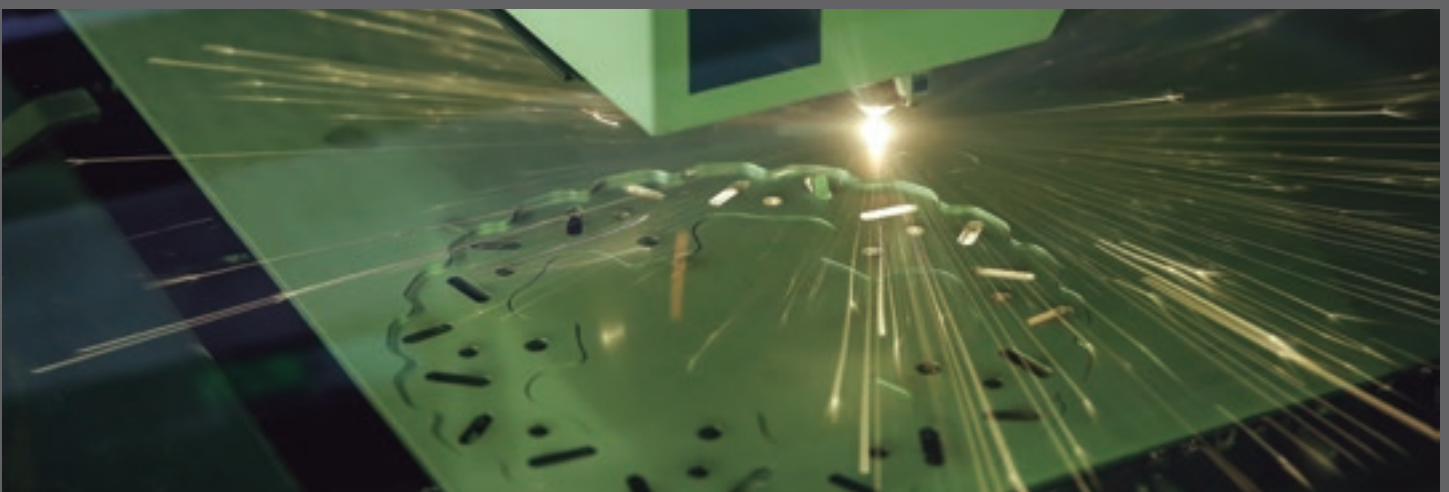

ECE R90
APPROVED

90R



SCOOTER

SEMI METAL

TRIAL TOP

SINTERED

Sport R

Racing

Brake pads are fundamental elements in any brake system because they are directly responsible for transmitting the power of the caliper to the brake disc so that it can overpower the brake pads without strain. Galfer has developed specific compounds for each use and motorcycle model looking to offer the top performances in all type of driving and for all the profiles and needs of users.

General features:

- Powerful, progressive & modular brake.
- Low wear rate and minimum noise.
- Maximum resistance to the fade effect.
- Efficiency on dry and wet conditions.
- No wear on brake disc.
- Certificate ECE R90 for all brake pads compounds.



90R

Las pastillas de freno son un elemento fundamental en el sistema de frenado, porque son las responsables directas de transmitir la fuerza de la pinza al disco, por lo que están sometidas a grandes esfuerzos. Galfer ha desarrollado compuestos específicos para cada uso y tipo de motocicleta, buscando ofrecer las máximas prestaciones en todo tipo de conducción y para todos los perfiles y necesidades de usuarios.

Características principales:

- Frenada potente, progresiva y modulable.
- Bajo índice de desgaste y mínimo ruido.
- Máxima resistencia al efecto "fade".
- Muy eficiente en seco y mojado.
- Mínima agresividad sobre el disco.
- Certificado ECE R90 para todos los compuestos de pastillas de freno.



90R

Le pastiglie freno sono elementi fondamentali di ogni impianto frenante in quanto responsabili di trasmettere la forza della pinza al disco, sono quindi sottoposte a grandi sforzi. Galfer ha sviluppato mescole specifiche per tutti i modelli di motocicli, cercando di offrire la massima prestazione per tutti gli stili di guida e per tutte le necessità del pilota.

Caratteristiche principali:

- Frenata potente, progressiva e modulare.
- Basso indice di consumo e rumore.
- Massima resistenza al fading.
- Molto efficace su asciutto e bagnato.
- Minima abrasione del disco.
- Certificato ECE R90 per tutte le mescole delle pastiglie dei freni.



90R

Les plaquettes de frein sont un élément fondamental d'un système de freinage car elles transmettent la force de l'étrier au disque de frein, et sont donc soumises à de gros efforts. Galfer, a développé des composants spécifiques pour chaque usage et type de motos, en cherchant à offrir les prestations maximales dans tous types de conduite et pour tous les profils de pilotage.

Caractéristiques principales:

- Freinage puissante, réglable et progressif.
- Faible taux d'usure et de bruits.
- Résistance maximale à l'effet "fade".
- Très efficace sur sec et mouillé.
- Faible agressivité sur le disque de frein.
- Certificat ECE R90 pour tous les composés de plaquettes de frein.



90R

BRAKE PADS COMPOUND APPLICATIONS
APLICACIÓN DE LOS COMPUESTOS DE LAS PASTILLAS DE FRENO

Scooter Street



Sport



Off-Road



Trial

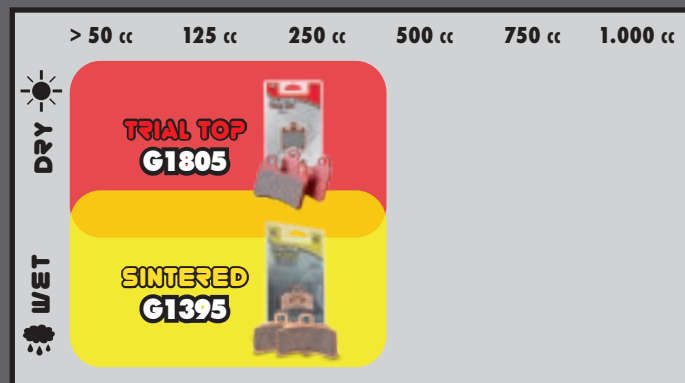
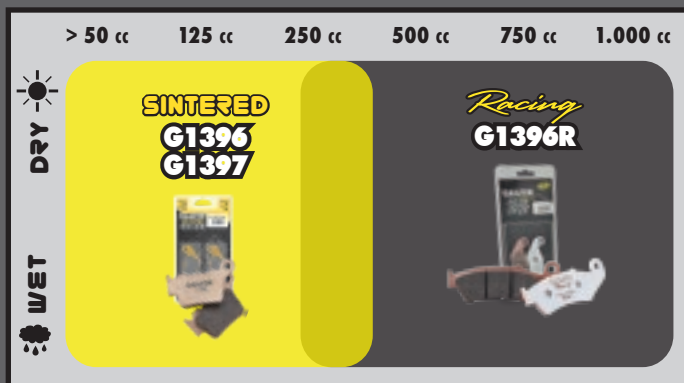

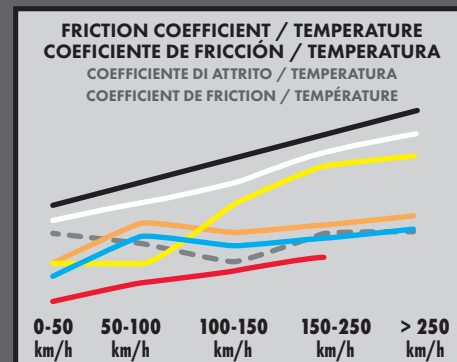
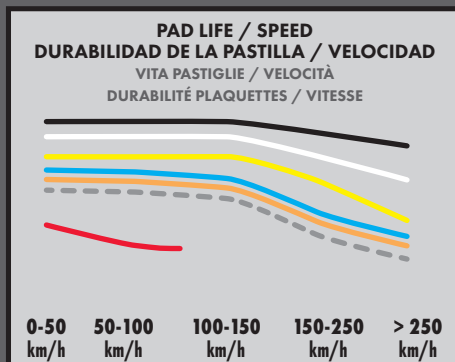
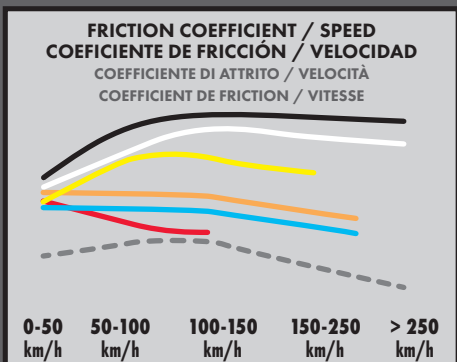

BRAKE PADS COMPOUND COMPARATIVE
COMPARATIVA DE LOS COMPUESTOS DE LAS PASTILLAS DE FRENO



SEMI METAL SCOOTER COMPOUND (G1050)

 Semi-metallic compound designed to produce excellent performance, providing maximum safety even when used on small and medium sized motorcycles. Consistent qualities under all weather conditions.

 Compuesto semimetálico diseñado para ofrecer un excelente rendimiento y la máxima seguridad incluso en motocicletas de tamaño pequeño y mediano. Mantiene sus cualidades en todo tipo de condiciones climáticas.

 Mescola semimetallica, ideata per avere ottime prestazioni e massima sicurezza anche con motocicli di piccola media cilindrata. Mantiene le sue caratteristiche con ogni condizione atmosferica.

 Matériel de friction semi-métallique, conçu pour avoir d'excellentes performances et une sécurité maximale même avec des motos de petites et moyennes cylindrées. Il maintient ses qualités dans toutes les conditions météorologiques.

SEMI METAL STREET COMPOUND (G1054)

 This compound embodies the past, present and future of semi-metallic production at GALFER. It has been manufactured for years with minor improvements, and it's still used today in several OE plants. The G1054 has an excellent coefficient of friction and low wear, offering progressive and effective braking. All these features make the compound suitable for all kinds of motorcycle.

 Este compuesto representa el pasado, el presente y el futuro de la producción semimetálica en GALFER. Ha sido producida durante años con pequeñas mejoras y hoy en día aún la utilizan muchas plantas de OE. Su excelente coeficiente de fricción, su bajo desgaste y su frenada progresiva y efectiva hacen que el G1054 sea un compuesto adecuado para los recambios de cualquier tipo de motocicleta.

 Questa mescola rappresenta il passato, il presente ed il futuro della produzione semimetallica in GALFER. Da anni si produce questa mescola, sempre con piccoli miglioramenti, ed ancora oggi viene usata in vari impianti originali OE. Ottimo coefficiente di attrito, consumi contenuti, frenata progressiva ed efficace, tutte queste caratteristiche fanno della G1054 una mescola adatta al ricambio di ogni tipo di motociclo.

 Ce matériel de friction représente le passé, le présent et le futur de la production semi-métallique chez GALFER. Ce matériel de friction est produit depuis des années avec des améliorations techniques régulières, il est toujours apprécié et utilisé par les usines en première monte d'origine. Il présente un excellent coefficient de friction, une faible usure, un freinage progressif et efficace. La plaquette G1054 est un produit qui convient à tous types de 2 roues.

SEMI METAL TRIAL TOP COMPOUND (G1805)

 This compound was studied and developed for Trial competition. The G1805 has been the chosen pad in the Trial World scene for years, used by the most prestigious Trial motorcycle brands, and also by most Trial enthusiasts because of the optimal braking it offers under all weather conditions.

 Compuesto estudiado y desarrollado para su uso en competición de Trial, durante años la pastilla reina de la escena del Trial mundial. Las marcas más prestigiosas de los fabricantes de motocicletas de Trial han utilizado las G1805 durante años en sus primeros equipos; y también las usan la mayoría de los apasionados del Trial porque garantiza siempre una frenada óptima en todas las condiciones climáticas.

 Mescola studiata e realizzata per l'uso agonistico Trial, da anni la regina incontrastata della scena mondiale del Trial. La G1805 viene usata da anni di serie nei primi montaggi dei marchi più prestigiosi dei produttori di moto da Trial, viene usata dalla maggior parte degli appassionati del trial perché garantisce sempre una frenata pronta con ogni condizione atmosferica.

 Matériel de friction étudié et développé pour une utilisation compétition TRIAL, plébiscité comme la meilleure plaquette sur la scène de la compétition mondiale TRIAL. La G1805 est également utilisée par les plus prestigieux fabricants mondiaux de moto de trial. Elle assure un freinage optimal dans toutes les conditions météorologiques.

SINTERED SCOOTER COMPOUND (G1380)

 G1380 a sintered pad designed as a replacement with specific features for maxi-scooters. Combines safe and progressive braking with a competitive price. G1380 guarantees safe braking and is able to stand high temperatures without fade. Performance is not effected by adverse weather conditions.

 G1380 pastilla sinterizada diseñada para el recambio con características específicas para los maxi scooter, que combina una frenada segura y progresiva con un precio competitivo. Garantiza una frenada segura, no tiene problemas con las altas temperaturas (FADE) y en condiciones climáticas adversas no altera su rendimiento.

 G1380 una pastiglia sinterizzata ideata per il ricambio con delle caratteristiche specifiche per il maxi scooter, abbina una frenata sicura e progressiva ad un prezzo competitivo. Garantisce una frenata sempre pronta e sicura, non teme le alte temperature d'uso (FADE) e non altera le sue prestazioni in condizioni atmosferiche avverse.

 G1380 une plaquette sinterisée présentant des caractéristiques spécifiques pour les maxi scoot associant un freinage sûr et progressif à un prix compétitif. Elle garantit un freinage puissant sans aucun effet 'fading' et constant dans toutes les conditions climatiques.



SINTERED STREET COMPOUND (G1370)

 Designed for road bike customers, G1370 is GALFER's OE product replacement. G1370 guarantees safe braking and is able to stand high temperatures without fade. Performance is not effected by adverse weather conditions. Combines safe and progressive braking with a competitive price.

 Creada para satisfacer a los clientes de motocicletas de carretera, un recambio a la altura del producto original. Garantiza una frenada segura, no tiene problemas con las altas temperaturas (FADE) y en condiciones climáticas adversas no altera su rendimiento. Combina una frenada segura y progresiva con un precio competitivo.

 G1370 creata per soddisfare la clientela che usa moto stradale, un ricambio che non teme paragoni con il prodotto originale. Garantisce una frenata sempre pronta e sicura, non teme le alte temperature d'uso (FADE) e non altera le sue prestazioni in condizioni atmosferiche avverse. Abbina una frenata sicura e progressiva ad un prezzo competitivo.

 La G1370 est une plaquette de frein sinter spéciale route qui remplace parfaitement les produits d'origine. Elle garantit un freinage puissant sans aucun effet 'fading' et constant dans toutes les conditions climatiques. Associant un freinage sûr et progressif à un prix compétitif.





SINTER TRIAL COMPOUND (G1395)



 The new brake pads compound G1395 has a high coefficient of friction both for static and high speed use, and always offers a powerful, steady and progressive feel. It offers optimal functioning in all conditions: dry, wet and muddy. The new brake pads also ranks high in durability compared with organic pads.

 El nuevo compuesto de pastillas de freno G1395 se caracteriza por su gran coeficiente de fricción, tanto en uso estático como en alta velocidad, que ofrece siempre un tacto potente, firme y progresivo. Su funcionamiento es óptimo en todo tipo de condiciones, tanto en seco, como en condiciones extremas de humedad y barro. Las nuevas pastillas de freno también destacan por su alta durabilidad en comparación con los compuestos orgánicos.

 Il nuovo composto per pastiglie freno G1395 è caratterizzato dall'elevato coefficiente di attrito, sia nell'impiego statico che ad alta velocità, garantendo così sempre una presa potente, ferma e graduale. Il suo funzionamento è eccellente su fondi stradali in qualsiasi condizione, sia sull'asciutto che in presenza di condizioni estreme su bagnato o sul fango. Le nuove pastiglie freno si contraddistinguono inoltre per la loro lunga durata rispetto a quelle prodotte con composti organici.

 Le nouveau composé des plaquettes de frein G1395 se caractérise par son coefficient de friction élevé, tant en mode statique qu'à grande vitesse, garantissant un toucher puissant, stable et progressif. Son fonctionnement est optimal tant sur sol sec que dans des conditions extrêmes d'humidité et de boue. Les nouvelles plaquettes de frein se distinguent également par leur haute durabilité par rapport aux composés organiques.





SINTERED OFF-ROAD COMPOUND G1396-97



 G1396 is a compound developed and manufactured in direct collaboration with Motocross and Enduro teams and riders. It's the result of hard work to improve and find the best braking performance in any kind of terrain. The G1396 clearly stands out thanks to effective, adaptable and progressive braking. G1396 has all the features to ensure the safety of the most demanding rider under all weather conditions. The G1397 offers the same features but for the ATV market.

 Compuesto desarrollado y fabricado en colaboración directa con equipos y pilotos del mundo del Cross y el Enduro, resultado de una constante mejora en la búsqueda de la frenada perfecta en todo tipo de terreno. Sin lugar a dudas, el G1396 destaca por su frenada eficaz, modulable y progresiva, con todas las características que garantizan la seguridad del piloto más exigente en todas las condiciones climáticas. El compuesto G1397 ofrece las mismas características, pero para el mercado ATV.

 G1396 è una miscela studiata e realizzata in collaborazione diretta con teams a piloti del mondiale di Cross ed Enduro, frutto di un costante miglioramento alla ricerca del freno perfetto in ogni tipo di terreno! Senza dubbio oggi la G1396 si distingue per la sua frenata efficace, modulabile e progressiva. Tutte caratteristiche che garantiscono anche al pilota più esigente sicurezza in ogni condizione atmosferica. Stessa cosa per la G1397 che è stata invece sviluppata per il mercato ATV.

 La G1396 est une plaquette dont le matériel de friction est issu du monde de la compétition MXGP et ENDURO WORLD CHAMPIONSHIP. Cette plaquette se distingue par son freinage puissant, adaptable et progressif pour les pilotes les plus exigeants en toutes conditions météorologiques. La G1397 présente les mêmes caractéristiques pour le marché des ATV.

SINTERED SPORT COMPOUND G1375



 An upgrade of G1370 designed to satisfy the most demanding customers who, besides the usual urban use, have a taste for sport riding. This compound has a high coefficient of friction and ensures excellent performance even at high temperatures. G1375 offers adjustable and safe braking under all conditions.

 Una mejora de la G1370, diseñada para satisfacer a los clientes más exigentes que, además del uso urbano habitual, desean una conducción más deportiva. Este compuesto, con un alto coeficiente de fricción, garantiza un rendimiento excelente incluso con altas temperaturas de uso. La G1375 ofrece una frenada modulable y segura en todo tipo de condiciones.

 Un upgrade della nostra G1370 studiata per soddisfare la clientela più esigente che oltre all'uso normale cittadino vuole usare il proprio mezzo in maniera più sportiva. Questa miscela dall'elevato coefficiente di attrito, garantisce prestazioni eccellenti fino alle più alte temperature d'uso. Frenata modulabile e sicura in ogni condizione sono la caratteristica principale della G1375.

 Cette est une évolution de la plaquette route G1370 pour une conduite plus sportive. Son matériel de friction présente un coefficient de friction élevé garantissant d'excellentes performances même à hautes températures d'utilisation (circuit). Cette plaquette G1375 est caractérisée par un freinage modulable et constant.

SINTERED OFF-ROAD RACING G1396R

**NEW
COMPOUND**

 GALFER launches the new G1396R brake pads, a new compound for the Off-Road motorcycle competition. The new compound assures a controlled braking while keeping the aggressive braking needed to ride under extreme conditions, and resists the maximum stress without compromising the performance. The new G1396R stands out for the new special ceramic paint coating, which acts as a heat shield reducing heat transfer to the braking system together with the slots on the friction material. Developed and tested on Off-Road races by the best riders of the MXGP, AMA SX and the Enduro World Championship.

 GALFER introduce en el mercado sus nuevas pastillas de freno G1396R, un nuevo compuesto dirigido a la competición de motos de campo. El nuevo compuesto garantiza una frenada modular, manteniendo la agresividad requerida en cualquier condición extrema y soportando el máximo estrés sin disminuir su rendimiento. El nuevo G1396R destaca visualmente por su pintura cerámica especial, que actúa como un escudo térmico adicional que reduce la transmisión de calor al sistema de frenos junto con las ranuras del material de fricción. Desarrolladas y probadas en las carreras Off-Road con los mejores pilotos del MXGP, AMA SX y del Campeonato del Mundo de Enduro.

 GALFER lancia sul mercato le sue nuove pastiglie freno G1396R, realizzate con un composto sviluppato specificatamente per le moto da competizione in offroad. Il nuovo composto garantisce una frenata modulare, mantenendo tuttavia l'aggressività necessaria in qualsiasi condizione estrema e sopportando le massime sollecitazioni senza ridurre le prestazioni. Le nuove pastiglie G1396R si distinguono esteticamente per la loro speciale verniciatura ceramica, che agisce come uno scudo termico e che, assieme alle scanalature del materiale di attrito, riduce la trasmissione del calore all'impianto frenante. Sviluppate e testate in offroad dai migliori piloti di MXGP, AMA SX e del Campionato del mondo di Enduro.

 GALFER lance sur le marché ses nouvelles plaquettes de frein G1396R, un nouveau composé destiné à la compétition de motos tout-terrain. Le nouveau composé garantit un freinage modulaire, conservant l'agressivité requise dans toute condition extrême et supportant les contraintes maximales sans entraîner une baisse de performance. Le nouveau G1396R se distingue visuellement par sa peinture spéciale céramique qui, associée aux rainures du matériau de friction, agit comme un bouclier thermique supplémentaire permettant de réduire la transmission de chaleur au système de freinage. Ces plaquettes ont été développées et testées lors des courses Off-Road avec les meilleurs pilotes MXGP et AMA SX et avec le Champion du monde Enduro.





SINTERED ROAD SPORT RACING G1375R

**NEW
COMPOUND**

 GALFER launches the new Sport Racing G1375R brake pads made for sports bikes, and for road or circuit use. The new G1375R are made of sintered metal compound and stand out for their braking power, their high coefficient of friction and for being suitable for all conditions, especially with higher brake temperatures. As with its brother compound, the G1375, the new R brake pads will have a special ceramic coating that serves as a heat shield and reduces heat transmission to the braking system together with the slots on the friction material.

 GALFER lanza al mercado sus nuevas pastillas de freno Sport Racing G1375R especiales para motos deportivas y para uso en carretera abierta o en circuito. Las nuevas G1375R son de metal sinterizado y destacan por su alto poder de frenada, su elevado coeficiente de fricción y por ser aptas para todo tipo de condiciones, en especial con altas temperaturas en los frenos. Como ya sucede con su compuesto hermano, el G1375, las nuevas pastillas "R" también contarán con una pintura cerámica especial en el soporte que actúa como escudo térmico adicional y reduce la transmisión de calor al sistema de frenos junto las ranuras del material de fricción.

 GALFER lancia sul mercato le sue nuove pastiglie freno Sport Racing G1375R, sviluppate specificatamente per moto sportive e per l'impiego in offroad o su circuito. Le nuove G1375R sono realizzate in metallo sinterizzato e si distinguono per la loro elevata potenza frenante, l'alto coefficiente di attrito e l'idoneità a qualsiasi condizione di marcia, in particolare ad alte temperature del freno. Analogamente all'altro modello della stessa famiglia G1375, anche le nuove pastiglie "R" sono dotate della speciale verniciatura ceramica sul supporto, che agisce come ulteriore protezione termica che, assieme alle scanalature del materiale di attrito, riduce la trasmissione del calore all'impianto frenante.

 GALFER lance sur le marché ses nouvelles plaquettes de frein Sport Racing G1375R destinées aux motos de sport et pour un usage sur route ouverte ou sur circuit. Les nouvelles G1375R sont constituées de métal fritté et se distinguent par leur grande puissance de freinage, leur coefficient de friction élevé et par le fait qu'elles conviennent à tous types de conditions, notamment lorsque les freins atteignent des températures importantes. Comme pour le G1375, le support des nouvelles plaquettes « R » est également revêtu d'une peinture spéciale céramique qui, associée aux rainures du matériau de friction, agit comme un bouclier thermique supplémentaire et permet de réduire la transmission de chaleur au système de freinage.



Classic

Disc Wave®

SKULL

CUBIQ®



 Galfer brake discs represents the best example of research and development by Galfer. Laser cut, stainless steel and high carbon content. There is a direct application of competitive technology for any user. Direct replacement system that does not require brackets or any extra parts, it bolts just like a stock disc would. General features:

- Lower weight of the unsprung masses.
- More braking power.
- Better heat dissipation.
- Low working temperature.
- Less tendency to warp.
- Excellent resistance to corrosion.
- Stainless steel high carbon content.
- Anodized or chromed high resistance aluminium (7075 T6 - 6082 T6) or stainless steel carrier.
- "Disc Wave®" is an intellectual property of Galfer Industries SA, patented in Europe and America.



 Los discos de freno Galfer suponen la mejor expresión del trabajo en investigación y desarrollo por parte de Galfer. Cortados en láser a partir de acero inoxidable de alto contenido en carbono, suponen la aplicación directa de una tecnología de la alta competición al alcance de cualquier usuario. Reemplazan a los discos originales sin necesidad de adaptación o manipulación. Características principales:

- Menor peso de las masas no suspendidas.
- Mayor potencia de frenada.
- Mejor capacidad de disipación del calor.
- Menor temperatura de trabajo.
- Menor tendencia a la deformación.
- Excelente resistencia a la corrosión.
- Acero inoxidable de alto contenido en carbono.
- Núcleo anodizado o cromado, en aluminio de alta resistencia (7075 T6 - 6082 T6) o en acero inoxidable.
- El "Disc Wave®" es una propiedad intelectual de Industrias Galfer SA, patentada en Europa y America.



 I dischi Galfer rappresentano l'esempio migliore di Ricerca e Sviluppo di Galfer. I dischi Galfer vengono prodotti con macchine a taglio laser utilizzando la miglior qualità di acciaio inossidabile ad alto contenuto di carbonio. Le tecnologie di produzione derivano direttamente dalle competizioni e rese disponibili a tutti gli utenti. Il montaggio non richiede staffe o parti supplementari e sono compatibili ai ricambi originali. Caratteristiche principali:











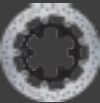
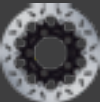



- Minor peso delle masse non sospese.
- Maggior potenza frenante.
- Miglior dissipazione del calore.
- Minor temperatura d'utilizzo.
- Una minore tendenza a deformarsi.
- Eccellente resistenza alla corrosione.
- Acciaio inossidabile ad alto contenuto di carbonio.
- Mozzo anodizzato o cromato in lega di alluminio ad alta resistenza ergal (7075 T6 - 6082 T6) o in acciaio inossidabile.
- Il disco freno "Disc Wave®" è una proprietà intellettuale di Industrias Galfer SA protetta da brevetto in Europa ed America.

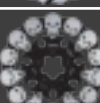
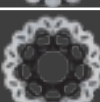

 Les disques de frein Galfer sont les meilleurs exemples des prouesses techniques du département Recherche & Développement de Galfer. Tranchés au laser dans le meilleur acier inoxydable à forte teneur en carbone, le procédé de fabrication est une technologie issue de la compétition destinée à tous les utilisateurs du marché. Ils remplacent les disques d'origine sans nécessité d'adaptation ou de transformation. Caractéristiques principales:

- Moins de poids des masses non suspendues.
- Une plus grande puissance de freinage.
- Une meilleure capacité de dissipation de la chaleur.
- Une faible température de travail.
- Moins tendance à se déformer.
- Excellente résistance à la corrosion.
- Acier inoxydable à forte densité de carbone.
- Frette intérieure anodisée ou chromée avec aluminium à haute résistance (7075 T6 - 6082 T6) ou avec acier inoxydable.
- Les disques de frein "Disc Wave®" sont la propriété intellectuelle de Industrias Galfer SA et sont protégés par un brevet en Europe et en Amérique.

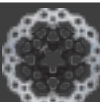

SHAPE	TYPE	EXT. SIZE	CENTER	TRACK	CODIFICATION	IMAGE	
Round Disc Disco Redondo	Fixed Fijo (V)	Original Original	NA	Holes Agujeros	V		
	Floating Flotante (F)		Steel Acero (FL)		FLV		
			Aluminium Aluminio (CV)		CV		
Disc Wave® Disco Wave	Fixed Fijo (W)	Oversize Sobremedida (S)	NA	Solid Lleno	W		
				Grooved Ranurado	WLL		
				Holes Agujeros	RW		
				Grooved Ranurado	WS		
				Skull Calaveras	RWS		
	Floating Flotante (F)	Original Original	Oversize Sobremedida (S)	Steel Acero (FL)	Holes Agujeros	RH	
					Grooved Ranurado	FLW	
					Skull Calaveras	FLS	
					Holes Agujeros	FRS	
					Grooved Ranurado	FRH	
					Aluminium Aluminio (CW)	CW	
Grooved Ranurado	Original Original	Oversize Sobremedida (S)	Aluminium Aluminio (CW)	Grooved Ranurado	CRW		
				Aluminium Aluminio (CW)	CRW		
CUBIQ® Disc	Fixed Fijo (Q)	Original Original	NA	Holes Agujeros	Q		
	Floating Flotante (F)		Steel Acero (FL)		FLQ		

FIXED DISC WAVE® (W-WLL)

OE

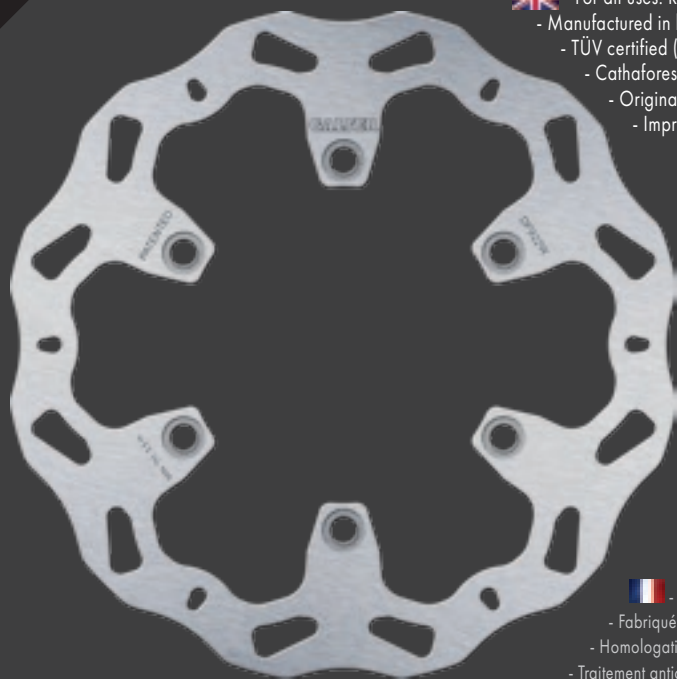

- For all uses: Road and Off-Road.
- Manufactured in high carbon stainless steel, laser-cut.
- TÜV certified (KBA No. 61147)
- Cathaforesis-treated to prevent corrosion.
- Original equipment manufacturer.
- Improves braking performance when used with GALFER brake pads.



- Para todo tipo de uso: carretera y Off-Road.
- Fabricado en acero inoxidable de alto contenido en carbono mediante corte láser.
- Homologación TÜV (KBA nº61147)
- Tratamiento de cataforesis que evita la corrosión.
- Disco utilizado en primer equipo (OEM).
- Las prestaciones de frenada mejoran si se utilizan las pastillas de freno GALFER en el compuesto recomendado.



- Per tutti gli usi: strada ed Off-Road.
- Realizzato in acciaio inossidabile ad alto tenore di carbonio tagliato al laser.
- Certificazione TÜV (KBA nº61147)
- Trattamento di cataforesi per evitare la corrosione.
- Dischi di primo equipaggiamento (OEM).
- Ottimizza la frenata usando le pastiglie di freno GALFER della miscela raccomandata.



- Pour tous usages : route et off-road.
- Fabriqué en acier inoxydable à haute teneur en carbone par découpe laser.
- Homologation TÜV (KBA nº61147)
- Traitement anticorrosion par cathaphorèse.
- Disque utilisé en équipement d'origine (OEM).
- Amélioration des performances de freinage grâce aux plaquettes de frein GALFER utilisées avec le matériel de friction recommandé.

FIXED OVERSIZE DISC WAVE® (WS)



- New, exclusive, and specialized Wave design for Off-Road.
- Bigger outside diameter provides more braking power.
- 25% weight reduction to the original.
- Improved heat dissipation.
- Requires a caliper adapter bracket.



- Nuevo diseño exclusivo Wave especial para Off-Road.
- Más potencia de frenada gracias a su mayor diámetro exterior.
- Reducción del 25% del peso respecto al disco original.
- Mayor capacidad de disipación del calor.
- Precisa de separador de pinza de freno.



- Nuovo design esclusivo Wave speciale per Off-Road.
- Più potenza di frenata grazie all'aumento del diametro esterno.
- Riduzione del 25% del peso rispetto al disco originale.
- Incremento della dissipazione del calore.
- Ha bisogno di un adattatore di pinza di freno.



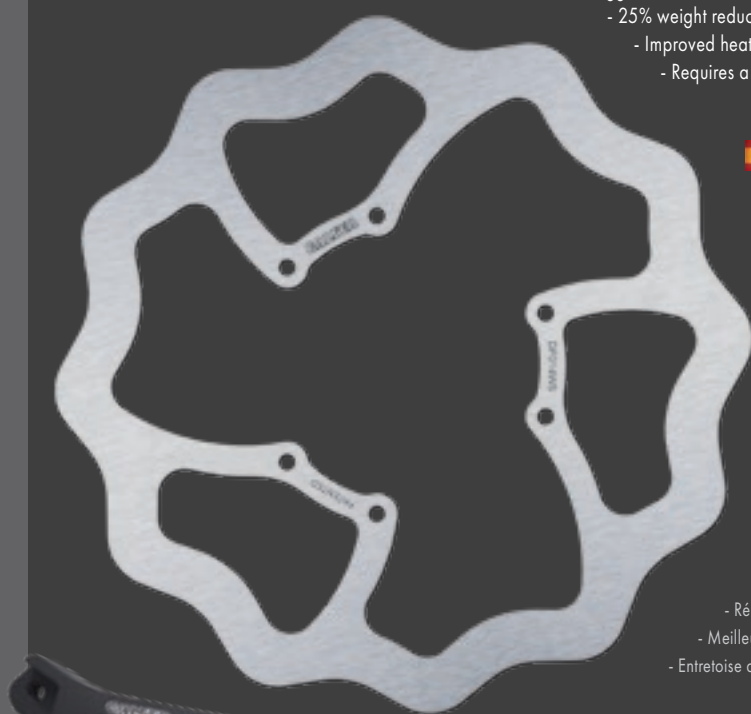

- Nouvelle conception exclusive Wave développé pour l'off-road.
- Plus de puissance de freinage grâce à l'augmentation du diamètre extérieur.
- Réduction de 25 % du poids par rapport au disque original.
- Meilleure capacité de dissipation de la chaleur.
- Entrenoise d'écartement d'étrier de frein nécessaire.





for axial caliper

FIXED GROOVED DISC WAVE® (RW-RH)

-  - Laser-cut and CNC high carbon stainless steel grooved rotor.
- The grooved rotor ensures water and dirt are better dispersed.
 - 30% weight reduction to the original.
 - Improved heat dissipation.

-  - Pista de freno ranurada fabricada mediante corte láser y CNC en acero inoxidable de alto contenido en carbono.
- Las ranuras de ambas caras de la pista de freno permiten una mejor evacuación del agua y la suciedad.
 - Reducción del 30% del peso respecto al disco original.
 - Mayor capacidad de disipación del calor.

-  - Fascia frenante scanalata realizzata in acciaio inossidabile ad alto tenore di carbonio tagliata al laser e CNC.
- Scanalature su entrambe facce della fascia frenante che permette migliorare l'evacuazione dell'acqua e dello sporco.
 - Riduzione del 30% del peso rispetto al disco originale.
 - Incremento della dissipazione del calore.

-  - Piste de freinage rainurée en acier inoxydable à haute teneur en carbone, fabriquée par découpe laser et CNC.
- Améliore l'évacuation de l'eau et de la saleté grâce aux rainures sur les deux faces du disque.
 - Réduction de 30% du poids par rapport au disque original.
 - Meilleure capacité de dissipation de la chaleur.



FIXED GROOVED OVERSIZE DISC WAVE® (RWS)

-  - Laser-cut and CNC high carbon stainless steel grooved rotor.
- Bigger outside diameter provides more braking power.
 - The grooved rotor ensures water and dirt are better dispersed.
 - The weight reduction (unsprung mass reduction; gyroscopic effect minimization) improves handling of the bike.
 - One of the best options in the market, widely used at the AMA SX and MXGP.
 - Requires a caliper adapter bracket.

-  - Pista de freno ranurada fabricada mediante corte láser y CNC en acero inoxidable de alto contenido en carbono.
- Mayor potencia de frenada gracias su mayor diámetro exterior.
 - Las ranuras de ambas caras de la pista de freno permiten una mejor evacuación del agua y la suciedad.
 - Mejora del manejo de la moto gracias a la reducción de peso en masa no suspendida (minimizando el efecto giroscópico).
 - Una de las mejores opciones del mercado, muy utilizado en el AMA SX y MXGP.
 - Precisa de separador de pinza de freno.

-  - Fascia frenante scanalata realizzata in acciaio inossidabile ad alto tenore di carbonio tagliata al laser e CNC.
- Più potenza di frenata grazie all'aumento del diametro esterno.
 - Scanalature su entrambe facce della fascia frenante che permette migliorare l'evacuazione dell'acqua e dello sporco.
 - Grazie alla riduzione di peso (riduzione di massa non sospesa - effetto giroscopico) si migliora il maneggio della motocicletta.
 - Dei migliori del mercato, viene utilizzato all'AMA SX ed al MXGP.
 - Ha bisogno di un adattatore di pinza di freno.

-  - Piste de freinage rainurée en acier inoxydable à haute teneur en carbone, fabriquée par découpe laser et CNC.
- Plus de puissance de freinage grâce à l'augmentation du diamètre extérieur.
 - Améliore l'évacuation de l'eau et de la saleté grâce aux rainures sur les deux faces du disque.
 - Améliore la maniabilité de la moto grâce à la réduction de poids en « masse non suspendue » (effet gyroscopique).
 - Une des meilleures solutions, très utilisée dans les championnats AMA SX et MXGP.
 - Entretien d'écartement d'étrier de frein nécessaire.

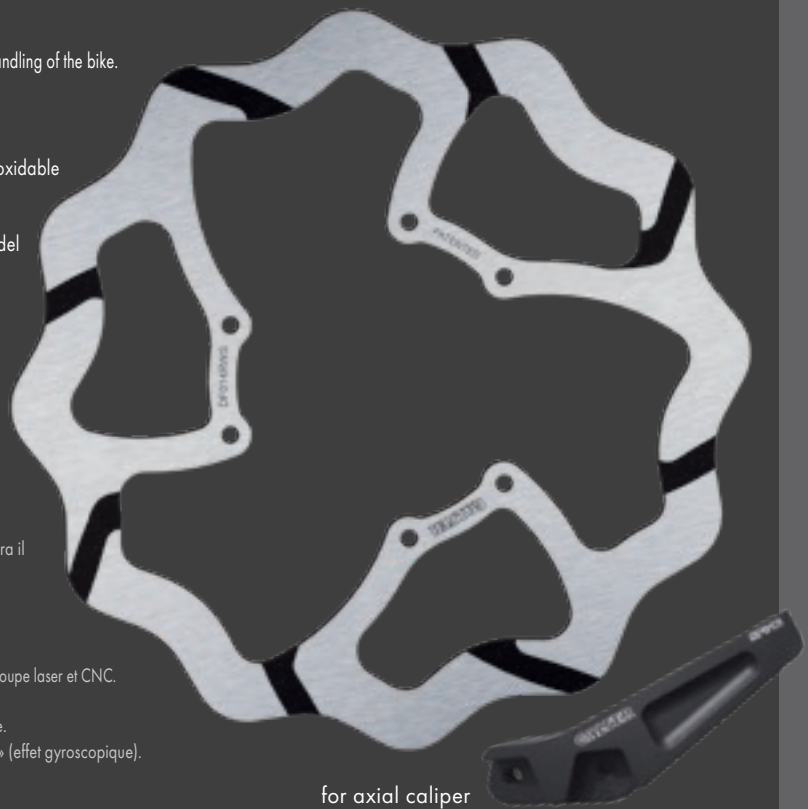



for axial caliper

FLOATING DISC WAVE® (FLW)

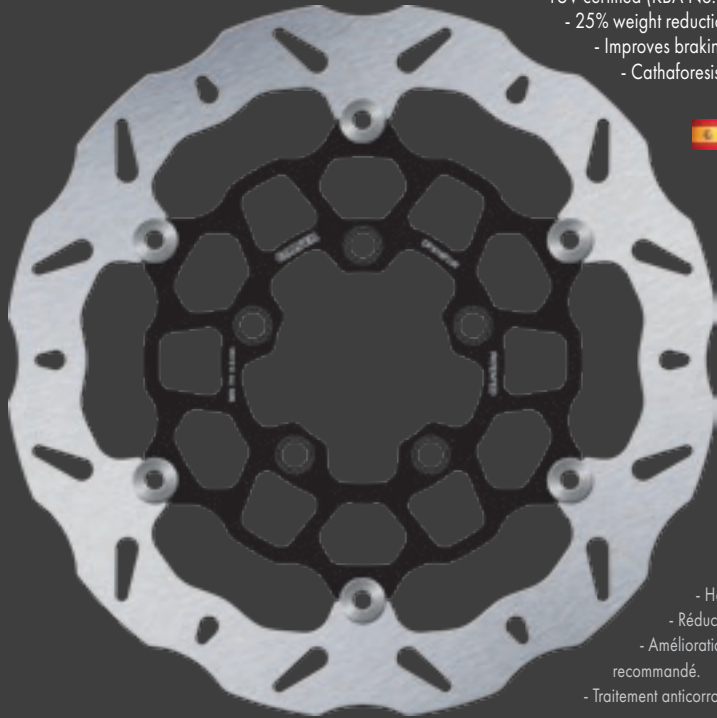
OE



-  - Laser-cut high carbon stainless steel brake band and stainless steel core.
- TÜV certified (KBA No. 61148)
- 25% weight reduction to the original.
- Improves braking performance when used with GALFER brake pads.
- Cathaforesis-treated to prevent corrosion.

-  - Pista de freno fabricada mediante corte láser en acero inoxidable de alto contenido en carbono y núcleo en acero inoxidable.
- Homologación TÜV (KBA nº61148)
- Reducción del 25% del peso respecto al disco original.
- Las prestaciones de frenada mejoran con el uso de las pastillas de freno GALFER en el compuesto recomendado.
- Tratamiento de cataforesis que evita la corrosión.

-  - Fascia frenante realizzata in acciaio inossidabile ad alto tenore di carbonio tagliato al laser e nucleo interno in acciaio inossidabile.
- Certificazione TÜV (KBA nº61148)
- Riduzione del 25% del peso rispetto al disco originale.
- Ottimizza la frenata usando le pastiglie di freno GALFER della miscela raccomandata.
- Trattamento di cataforesis per evitare la corrosione.

-  - Piste de freinage rainurée en acier inoxydable à haute teneur en carbone, fabriquée par découpe laser et frette en acier inoxydable.
- Homologation TÜV (KBA n° 61148)
- Réduction de 25 % du poids par rapport au disque original.
- Amélioration des performances de freinage grâce aux plaquettes de frein GALFER utilisées avec le matériel de friction recommandé.
- Traitement anticorrosion par cathaphorèse.

FLOATING OVERSIZE DISC WAVE® (FLS)

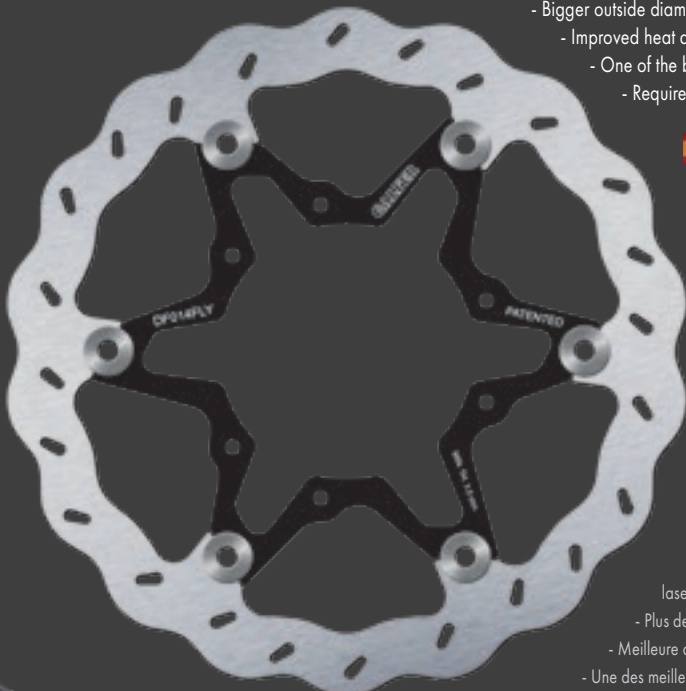

-  - Laser-cut high carbon stainless steel brake band and stainless steel core.
- Bigger outside diameter provides more braking power.
- Improved heat dissipation.
- One of the best options in the market, widely used at the AMA SX and MXGP.
- Requires a caliper adapter bracket.

-  - Pista de freno fabricada mediante corte láser en acero inoxidable de alto contenido en carbono y núcleo en acero inoxidable.
- Mayor potencia de frenada gracias a su mayor diámetro exterior.
- Mayor capacidad de disipación del calor.
- Una de las mejores opciones y muy utilizado en el AMA SX y MXGP.
- Precisa de separador de pinza de freno.

-  - Fascia frenante realizzata in acciaio inossidabile ad alto tenore di carbonio tagliato al laser e nucleo interno in acciaio inossidabile.
- Più potenza di frenata grazie all'aumento del diametro esterno.
- Incremento della dissipazione del calore.
- Dei migliori del mercato, viene utilizzato all'AMA SX ed al MXGP.
- Ha bisogno di un adattatore di pinza di freno.

-  - Piste de freinage rainurée en acier inoxydable à haute teneur en carbone, fabriquée par découpe laser et frette en acier inoxydable.
- Plus de puissance de freinage grâce à l'augmentation du diamètre extérieur.
- Meilleure capacité de dissipation de la chaleur.
- Une des meilleures solutions, très utilisée dans les championnats AMA SX et MXGP.
- Entroise d'écartement d'étrier de frein nécessaire.





for axial caliper

FLOATING GROOVED DISC WAVE® (FRW-FRS-FRH)

-  - Outside diameter bigger than the original rotor resulting in a better braking performance.
- The grooved rotor ensures water and dirt are better dispersed.
- One of the best options in the market, widely used at the AMA SX and MXGP.
- The weight reduction (unsprung mass reduction; gyroscopic effect minimization) improves handling of the bike.
- Requires a caliper adapter bracket.

-  - Medida de diámetro externo superior al disco original mejorando la potencia de frenada considerablemente.
- Las ranuras de ambas caras de la pista de freno permiten una mejor evacuación del agua y la suciedad.
- Una de las mejores opciones del mercado, muy utilizado en el AMA SX y MXGP.
- Mejora el manejo de la moto gracias a la reducción de peso en masa no suspendida (minimizando el efecto giroscópico).
- Precisa de separador de pinza de freno.

-  - Diametro esterno superiore al disco originale: la potenza di frenata migliora notevolmente.
- Scanalature su entrambe facce della fascia frenante che permette migliorare l'evacuazione dell'acqua e dello sporco.
- Dei migliori del mercato, viene utilizzato all'AMA SX ed al MXGP.
- Grazie alla riduzione di peso (riduzione di massa non sospesa - effetto giroscopico) si migliora il maneggio della motocicletta.
- Ha bisogno di un adattatore di pinza di freno.

-  - Diamètre extérieur supérieur au disque d'origine, amélioration considérable de la puissance de freinage.
- Améliore l'évacuation de l'eau et de la saleté grâce aux rainures sur les deux faces du disque.
- Une des meilleures solutions, très utilisée dans les championnats AMA SX et MXGP.
- Améliore la maniabilité de la moto grâce à la réduction de poids en « masse non suspendue » (effet gyroscopique).
- Entretien d'écartement d'étrier de frein nécessaire.

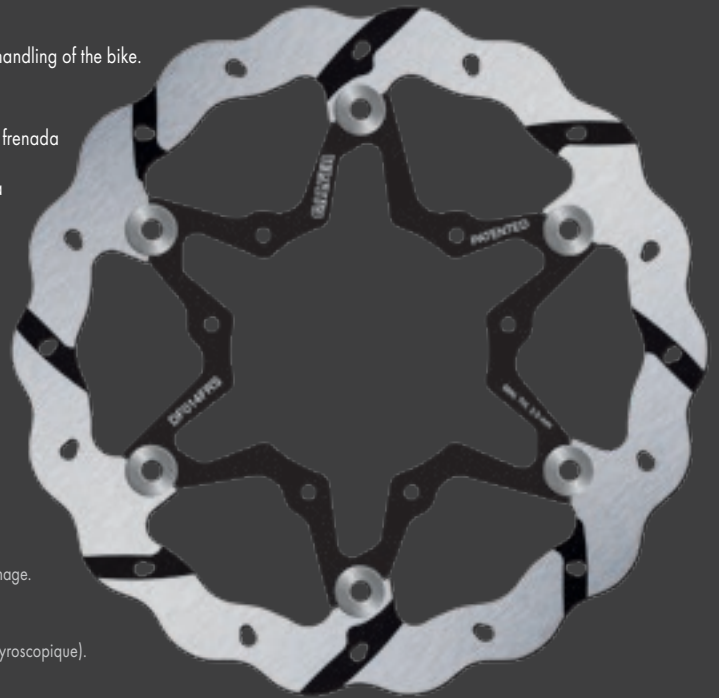

FLOATING STREET DISC WAVE® (CW-CRW)

-  - Laser-cut high carbon stainless steel brake band and high-strength anodised aluminium core (7075 T6 - 6082 T6).
- TÜV certified (KBA No. 61148)
- 25% weight reduction to the original.
- The weight reduction (unsprung mass reduction; gyroscopic effect minimization) improves handling of the bike.
- Improved braking sensation thanks to the floating system.
- Cathaforesis-treated to prevent corrosion.
- Fit for daily use, track days, competition, etc.

-  - Pista de freno fabricada mediante corte láser en acero inoxidable de alto contenido en carbono y núcleo anodizado en aluminio de alta resistencia (7075 T6 - 6082 T6).
- Homologación TÜV (KBA nº61148)
- Reducción del 25% del peso respecto al disco original.
- Mejora del manejo de la moto gracias a la reducción de peso en masa no suspendida (minimizando el efecto giroscópico).
- Mejor sensación de frenada gracias al sistema flotante.
- Tratamiento de cataforesis que evita la corrosión.
- Válido tanto para uso diario como para uso en tandas, competición, etc.

-  - Fascia frenante realizzata in acciaio inossidabile ad alto tenore di carbonio tagliata al laser e nucleo interno anodizzato in alluminio ad alta resistenza (7075 T6 - 6082 T6).
- Certificazione TÜV (KBA nº61148)
- Riduzione del 25% del peso rispetto al disco originale.
- Grazie alla riduzione di peso (riduzione di massa non sospesa - effetto giroscopico) si migliora il maneggio della motocicletta.
- Grazie al sistema flottante la sensazione di frenata è migliore.
- Trattamento di cataforesi per evitare la corrosione.
- Valido sia per uso stradale sia per track days, competizione, ecc.

-  - Piste de freinage rainurée en acier inoxydable à haute teneur en carbone, fabriquée par découpe laser et frettée en aluminium anodisé de haute résistance (7075 T6 - 6082 T6).
- Homologation TÜV (KBA nº 61148)
- Réduction de 25 % du poids par rapport au disque original.
- Améliore la maniabilité de la moto grâce à la réduction de poids en « masse non suspendue » (effet gyroscopique).
- Meilleure sensibilité de freinage grâce au système flottant.
- Traitement anticorrosion par cathaphorèse.
- Adapté aussi bien à l'usage courant qu'aux événements sur circuit, à la compétition, etc.

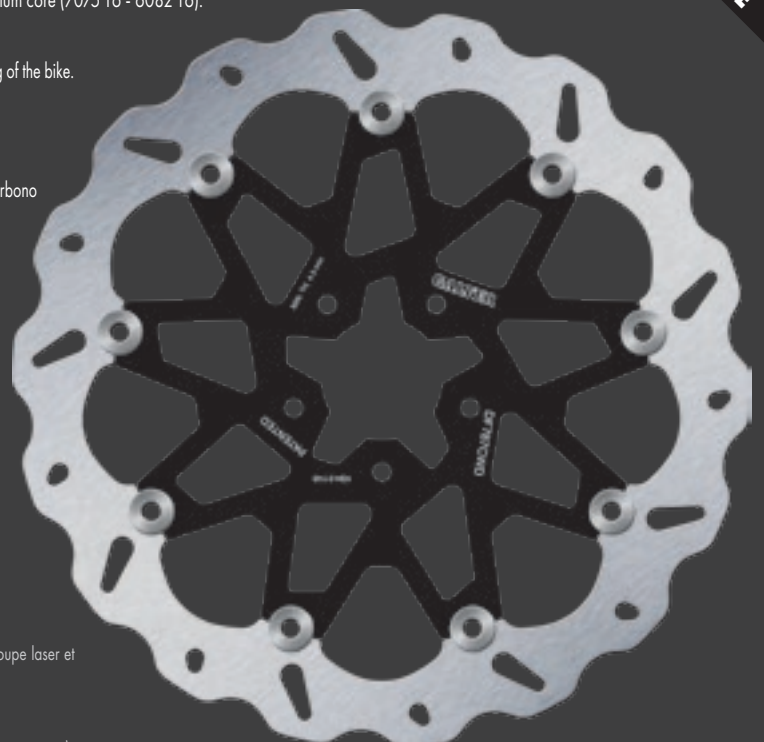

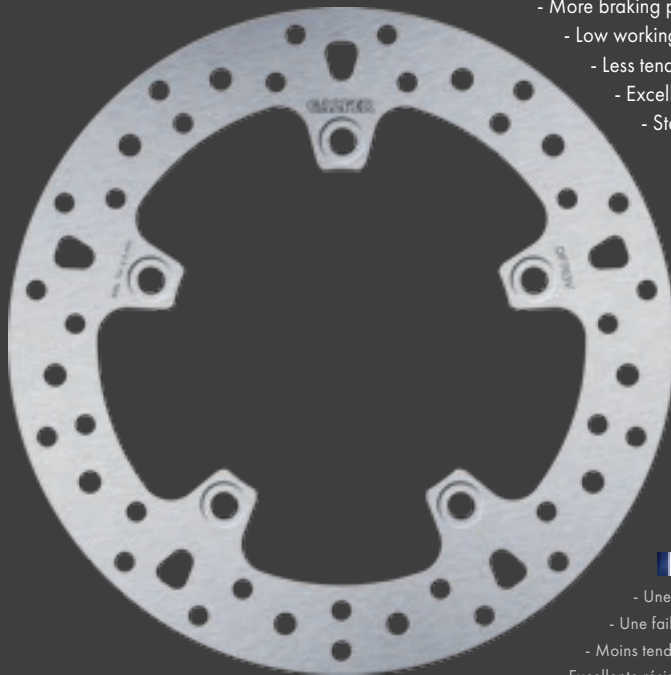

FIXED ROUND DISC (V)

OE



-  - Classic look.
- More braking power than the original disc.
- Low working temperature.
- Less tendency to warp.
- Excellent resistance to corrosion.
- Stainless steel high carbon content.

-  - Aspecto clásico
- Mayor potencia de frenada respecto al disco original.
- Menor temperatura de trabajo.
- Menor tendencia a la deformación.
- Excelente resistencia a la corrosión.
- Acero inoxidable de alto contenido en carbono.

-  - Aspetto classico
- Maggior potenza frenante sul disco originale.
- Minor temperatura d'utilizzo.
- Minore tendenza a deformarsi.
- Eccellente resistenza alla corrosione.
- Acciaio inossidabile ad alto contenuto di carbonio.

-  - Look classique
- Une plus grande puissance de freinage sur le disque d'origine.
- Une faible température de travail.
- Moins tendance à se déformer.
- Excellente résistance à la corrosion.
- Acier inoxydable à forte densité de carbone.

FLOATING ROUND DISC (FLV-CV)

OE

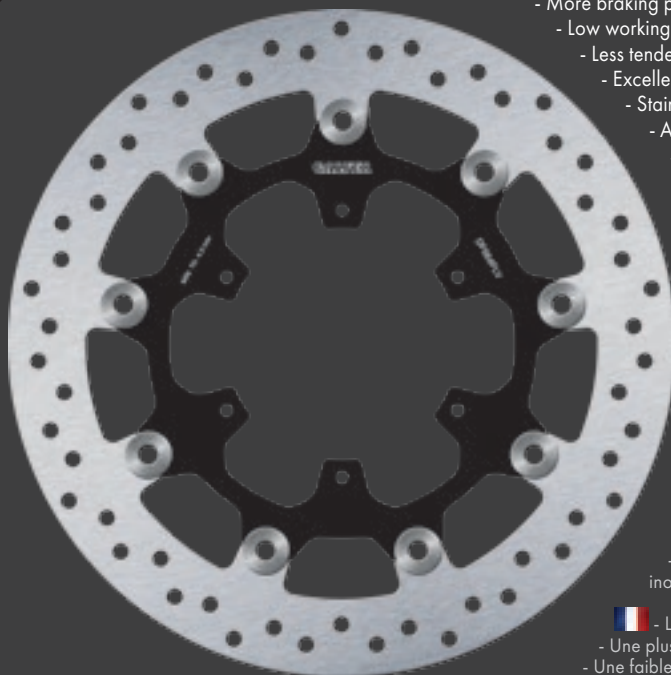

-  - Classic look.
- More braking power than the original disc.
- Low working temperature.
- Less tendency to warp.
- Excellent resistance to corrosion.
- Stainless steel high carbon content.
- Anodized or chromed high resistance aluminium (7075 T6 - 6082 T6) or stainless steel (AISI 420) carrier.

-  - Aspecto clásico
- Mayor potencia de frenada respecto al disco original.
- Menor temperatura de trabajo.
- Menor tendencia a la deformación.
- Excelente resistencia a la corrosión.
- Acero inoxidable de alto contenido en carbono.
- Núcleo anodizado o cromado, en aluminio de alta resistencia (7075 T6 - 6082 T6) o en acero inoxidable (AISI 420)

-  - Aspetto classico
- Maggior potenza frenante sul disco originale.
- Minor temperatura d'utilizzo.
- Minore tendenza a deformarsi.
- Eccellente resistenza alla corrosione.
- Acciaio inossidabile ad alto contenuto di carbonio.
- Mozzo anodizzato o cromato in alluminio ad alta resistenza (7075 T6 - 6082 T6) o in acciaio inossidabile (AISI 420)

-  - Look classique
- Une plus grande puissance de freinage sur le disque d'origine.
- Une faible température de travail.
- Moins tendance à se déformer.
- Excellente résistance à la corrosion.
- Acier inoxydable à forte densité de carbone.
- Frette centrale anodisée ou chromée avec aluminium de haute résistance (7075 T6 - 6082 T6) ou avec acier inoxydable (AISI 420)

FIXED CUBIQ® DISC (Q)

**NEW
DISC TYPE**



- CUBIQ® design inspired by the crystal molecules structure of the steel.
- Weight reduction due to the lighter brake track design.
- Better cooling thanks to increasing the convection perimeter and the cooling surface around the brake track.
- Dynamic unbalances decrease by having less unsprung mass that improves the maneuverability of the motorcycle.



- Diseño CUBIQ® inspirado en las moléculas de la estructura cristalina del acero.
- Reducción del peso debido al diseño de pista de freno más ligero.
- Mejor refrigeración gracias al aumento del perímetro de convección y de la superficie de enfriamiento alrededor de la pista del freno.
- Disminución de los desequilibrios dinámicos al tener menos masa no suspendida que mejora la maniobrabilidad de la motocicleta.



- Design CUBIQ® ispirato alle molecole della struttura cristallina dell'acciaio.
- Riduzione del peso grazie al design più leggero della guida freno..
- Migliore raffreddamento grazie all'aumento del perimetro di convezione e della superficie di raffreddamento attorno alla guida freno.
- Riduzione degli squilibri dinamici grazie alle minori masse sospese, che a loro volta migliorano la manovrabilità della moto.



- Conception CUBIQ® inspirée des molécules de la structure cristalline de l'acier.
- Réduction du poids grâce à une piste de freinage plus légère.
- Meilleur refroidissement grâce à l'augmentation du périmètre de convection et de la surface de refroidissement autour de la piste de freinage.
- Réduction des déséquilibres dynamiques du fait de la diminution de la masse non suspendue qui améliore la maniabilité de la moto.

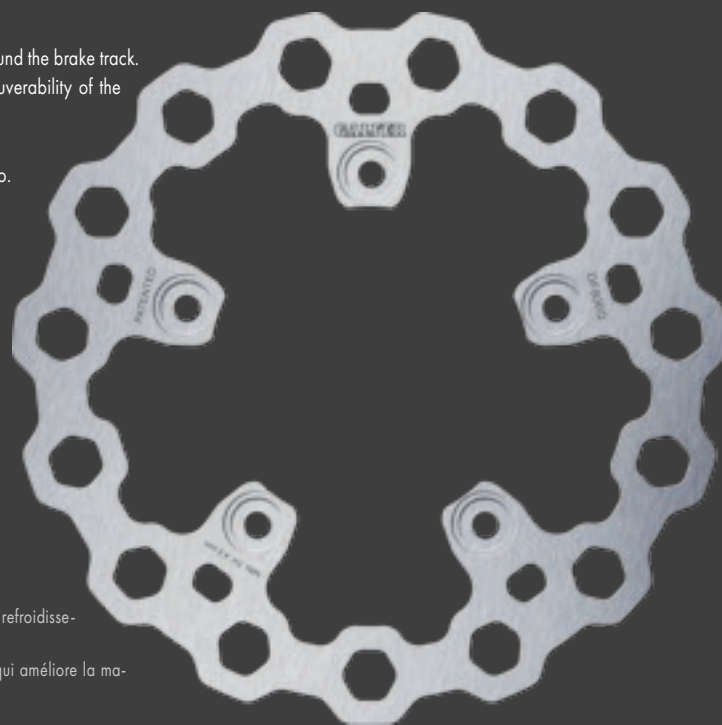

FLOATING CUBIQ® DISC (FLQ)

**NEW
DISC TYPE**



- CUBIQ® design inspired by the crystal molecules structure of the steel.
- Weight reduction due to the lighter brake track design.
- Better cooling thanks to increasing the convection perimeter and the cooling surface around the brake track.
- Dynamic unbalances decrease by having less unsprung mass that improves the maneuverability of the motorcycle.
- Stainless steel (AISI 420) carrier.



- Diseño CUBIQ® inspirado en las moléculas de la estructura cristalina del acero.
- Reducción del peso debido al diseño de pista de freno más ligero.
- Mejor refrigeración gracias al aumento del perímetro de convección y de la superficie de enfriamiento alrededor de la pista del freno.
- Disminución de los desequilibrios dinámicos al tener menos masa no suspendida que mejora la maniobrabilidad de la motocicleta.
- Núcleo de acero inoxidable (AISI 420)



- Design CUBIQ® ispirato alle molecole della struttura cristallina dell'acciaio.
- Riduzione del peso grazie al design più leggero della guida freno..
- Migliore raffreddamento grazie all'aumento del perimetro di convezione e della superficie di raffreddamento attorno alla guida freno.
- Riduzione degli squilibri dinamici grazie alle minori masse sospese, che a loro volta migliorano la manovrabilità della moto.
- Nucleo in acciaio inox (AISI 420).



- Conception CUBIQ® inspirée des molécules de la structure cristalline de l'acier.
- Réduction du poids grâce à une piste de freinage plus légère.
- Meilleur refroidissement grâce à l'augmentation du périmètre de convection et de la surface de refroidissement autour de la piste de freinage.
- Réduction des déséquilibres dynamiques du fait de la diminution de la masse non suspendue qui améliore la maniabilité de la moto.
- Support en acier inoxydable (AISI 420).

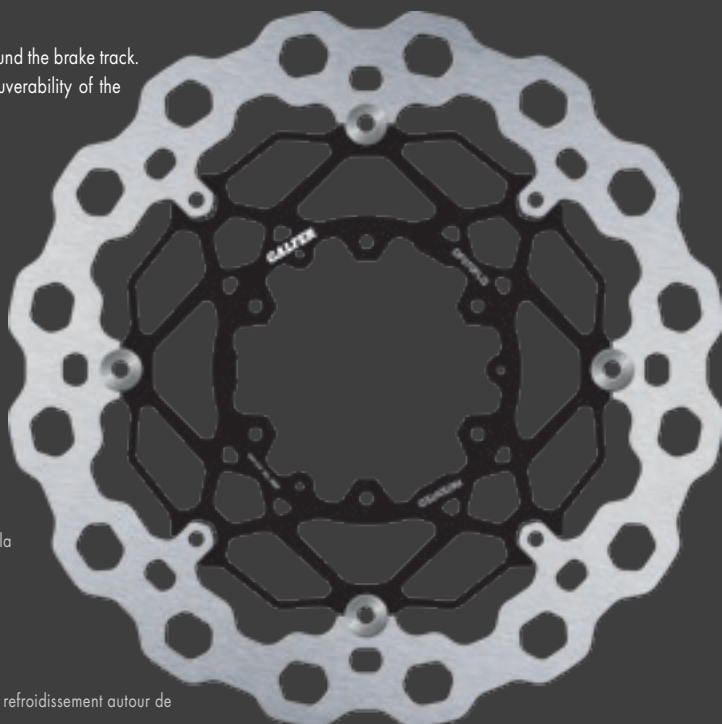



 FK Galfer metal hoses improved by more than 30% of the braking performance as they have a much lower expansion coefficient than traditional hoses. They are made of materials of the highest quality: braided stainless steel coated with PVC for the outside.

Key Features:

- Improves direct touch: strong, consistent and more accurate.
- Direct connection to the brake pump caliper.
- Increased speed of response.
- Do not corrode and resist the highest temperatures.
- Complete kits brake and clutch with 1, 2 or 3 tubes for each specific motorcycle model (tubes for off-road motorcycles include a protective sheath).
- Fittings and reusable supplied exploded.
- Tubes available in 4 colors (transparent, black, red and carbon) and fittings available in silver brass quality.

 Los latiguillos metálicos FK Galfer mejoran en más de un 30% el rendimiento de la frenada ya que gozan de un coeficiente de dilatación mucho menor que los tubos tradicionales. Están realizados en materiales de la más alta calidad: acero inoxidable trenzado recubierto de PVC para el exterior.

Características principales:

- Mejora directa del tacto: firme, constante y más preciso.
- Conexión directa de bomba a pinza de freno.
- Aumento de la velocidad de respuesta.
- No se oxidan y resisten las más altas temperaturas.
- Kits completos de frenado y de embrague con 1, 2 ó 3 tubos específicos para cada modelo de moto (los tubos para motos off-road incluyen una vaina protectora).
- Racorería y tubería reusable suministrado en despiece.
- Tubería disponible en 4 colores (transparente, negro, rojo y carbono) y racorería disponible en calidad latón plata.

 Le tubazioni freno aeronautiche FK Galfer migliorano il rendimento della frenata fino ad un 30% grazie alla maggiore resistenza alla dilatazione delle tubazioni tradizionali. Le tubazioni sono fatte con materiali della più alta qualità, una rete trecciata in acciaio inox il tutto ricoperto da una strato esterno in PVC.

Le caratteristiche principali di un FK Galfer sono:

- Miglioramento della sensibilità alla leva, frenata costante e precisa.
- Connessione diretta dalla pinza alla pompa freno.
- Risposta immediata, più rapida.
- Niente ossidazioni e maggior resistenza alle alte temperature.
- Grande assortimento, Kit freno e frizione completi con 1, 2 o 3 tubi a seconda delle esigenze e della tipologia di moto (le tubazioni off-road includono anche una guaina protettiva rigida).
- Raccorderia e tubazioni riutilizzabile.
- Tubazioni disponibili in 4 colorazioni (trasparente, nero, rosso e carbono) e qualità ottone silver di raccordi.

 Les durites métalliques FK Galfer améliorent de plus de 30% la performance du freinage car elles offrent un coefficient de dilatation beaucoup plus faible que les durites classiques. Elles sont fabriquées à partir de matériaux d'excellente qualité: enveloppe extérieure en acier inox tressé recouvert de PVC.

Caractéristiques principales:

- Améliore le feeling au levier, freinage constant et précis.
- Connexion directe au maître-cylindre de frein.
- Augmente la réactivité.
- Ne s'oxydent pas et résistent à des températures élevées.
- Kits complets de Frein et embrayage avec 1, 2 ou 3 durites suivant la spécificité de chaque moto (les durites pour motos « off road » incluent une gaine de protection).
- Raccords de connexion réutilisables pouvant être fournis séparément.
- Gains disponibles en 4 couleurs (transparente, noir, rouge e carbon) et qualité laiton argent raccords.



 Necessary element for assembling oversized brake discs with original or special calipers. Aluminium 7075 T6 or 6082 T6 made. CNC mechanized and anodized.

 Elemento imprescindible para el montaje de discos sobredimensionados con pinzas de origen o bien especiales. Fabricados en aluminio 7075 T6 ó 6082 T6. Mecanizados en CNC y anodizados.

 Elemento indispensabile se si decide di utilizzare dischi freno maggiorati con pinze originali o aftermarket. Prodotte in alluminio 7075 T6 O 6082 T6. Lavorazione macchine a controllo numerico CNC e anodizzate.

 Éléments indispensables pour le montage des disques oversized (grande taille) avec des étriers d'origine ou spéciaux. Fabriqués en aluminium 7075 T6 OU 6082 T6. Mécanisés en CNC et anodisé.

BRAKE SHOES · MORDAZAS DE FRENO

GANASCE FRENO · MÂCHOIRES DE FREIN



 Our brake shoes are supplied with the same compound as used for most of our OEM producers. They include all necessary devices for fast and easy replacement.

 Mordazas de freno con guarniciones de freno idénticas a las suministradas en OEM. Suministramos los conjuntos de mordazas forradas para freno de tambor con todos sus accesorios permitiendo una ágil y rápida sustitución del material original.

 Le nostre ganasce sono fornite con lo stesso composto utilizzato per la maggior parte dei nostri produttori OEM. Includono tutti i dispositivi necessari per una sostituzione rapida e semplice.

 Nos mâchoires de frein sont fournis avec le même composé que celui utilisé pour la plupart de nos producteurs OEM. Ils comprennent tous les dispositifs nécessaires pour un remplacement rapide et facile.

KITS OFF-ROAD FRONT DISC OVERSIZED



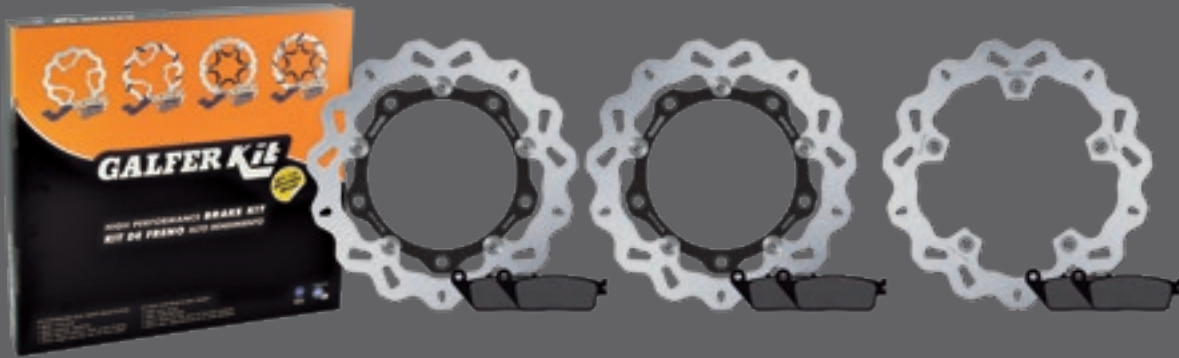

KITS ROAD FRONT & REAR DISC ORIGINAL OR OVERSIZED



 The GALFER KIT are composed of many different combinations of "Disc Wave®" with other brake system elements like brake pads, metallic lines, calipers, brackets and other promotional accessories (stickers, gloves, cap, etc.)

 Los GALFER KIT se componen de distintas combinaciones de "Discs Wave®" con otros elementos del sistema de freno, ya sean pastillas de freno, latiguillos de freno metálicos, pinzas, soportes para la pinza y otros accesorios promocionales como adhesivos, guantes, gorras, etc.

 I KIT GALFER sono composti da varie combinazioni di "Disc Wave®" con altri componenti: pastiglie freni, tubi freno in metallo, pinze e supporti, accessori promozionali come adesivi, guanti, cappelli, etc.

 Les KITS GALFER se composent de différentes combinaisons de "Disc Wave®" et autres composants du système de freinage, les jeux de plaquettes de frein, durites de frein en métal, des étriers, supports pour les étriers et autres accessoires promotionnels tels que des adhésifs, des gants, des casquettes, etc.



BRAKE CLEANER



BRAKE FLUID



TELEMETRY SENSOR ADAPTER



SHIM NOISE REDUCTION

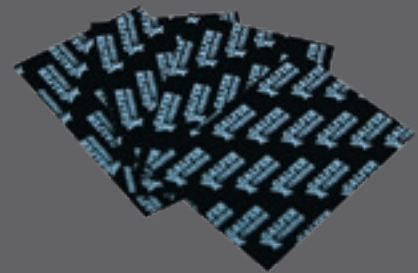

BRAKE PADS PACKAGING SYSTEM

PADS SET



207

112

12 PADS SETS

PADS BOX



213

114

140

4 BOXES (48 PADS SETS)

SHIPMENT BOX



225

290

238

max. 1200
(5 files)

PALLET SYSTEM



1200

800

1PALLET = 5 FILES
x
12 SHIPMENT BOXES
=
240 PADS BOX
=
2.880 PADS SETS (max.)

KTM **TRUST** **IN** **GALFER** PERFORMANCE BRAKING SYSTEMS

GALFER OEM & OES SUPPLIER
KTM POWERPARTS



KTM
65 SX



KTM
50 SX



KTM
FREERIDE 250



KTM
450 SX-F



KTM
500 EXC-F



HUSQVARNA
FS450 SM



KTM
1290 SUPERDUKE





KTM
690 DUKE R





 GALFER supplies the best brands. The quality and guarantee of our products are the reasons that explain why the most prestigious motorcycles and mopeds manufacturers rely on us from decades.

 GALFER fabrica para las mejores marcas. La calidad y garantía de nuestros productos son el motivo por el que los fabricantes de motocicletas y ciclomotores más prestigiosos confían en nosotros desde hace décadas.

 GALFER produce per le migliori marche. La qualità e la garanzia dei nostri prodotti sono la ragione per la quale i produttori di motocicli e ciclomotori più prestigiosi si affidano a noi.

 GALFER fournit les meilleures marques. La qualité et la garantie de nos produits sont la raison pour laquelle les fabricants de motocyclettes et cyclomoteurs les plus prestigieux nous font confiance depuis des décennies.



ALEX CRIVILLÉ

1989
JJ Cobas



EMILIO ALZAMORA

1999
Aprilia



JORGE LORENZO

2006-2007
Aprilia



MARC MÁRQUEZ

2010 (125cc) & 2012 (Moto2)
Derbi & Suter



LAIA SANZ

2012 & 2013
Gas Gas



ALEX MÁRQUEZ

2014
Honda HRC



TONI BOU

2016, 2017, 2018, 2019 & 2020
Montesa-Honda



STEVE HOLCOMBE

2016, 2017, 2018 & 2019
Beta



KIARA FONTANESI

2017 & 2018
Yamaha



JOAN MIR

2017
Honda HRC



JORGE MARTIN

2018
Honda HRC



LORENZO DALLA PORTA

2019
Honda HRC





REALE-AVINTIA

Johan Zarco (FRA)
Tito Rabat (SPA)



PRAMAC RACING

Pecco Bagnaia (ITA)



SAG RACING TEAM

Remy Gardner (AUS)
Kasma Daniel (MAL)



LEOPARD RACING

Jaume Masia (SPA)
Dennis Foggia (ITA)



GRESINI RACING

Gabriel Rodrigo (ARG)
Jeremy Alcoba (SPA)



EVAN BROS BARDAHL

Andrea Locatelli (ITA)



MV AGUSTA CORSE

Randy Krummenacher (SUI)
Raffaele De Rosa (ITA)
Federico Fuligni (ITA)



HONDA SR

Jeremy Van Horebeek (BEL)
Valentin Guillod (SUI)



YAMAHA SM ACTION

Henry Jacobi (GER)
Maxime Renaux (ITA)
Andrea Adamo (ITA)



BETA FACTORY TEAM

Steve Holcombe (GBR)
Brad Freeman (GBR)
Benjamin Herrera (CHI)



SHERCO FACTORY TEAM

Mario Román (ESP)
Wade Young (RSA)



MONTESA-HONDA

Toni Bou (ESP)
Takahisa Fujinami (JPN)



GALFER

Racing



RACING CATALOGUE
Webiste download

**DOWNLOAD
THE CATALOGUE**



**PASSION
NEVER
STOPS**

CUBIQ®

NEW DISC BY
GALFER



CUBIQ CATALOGUE
Webiste download

**DOWNLOAD
THE CATALOGUE**



1 COOLING IMPROVEMENT

Increasing the convection perimeter generates more cooling surface around the brake track and a better temperature dissipation.

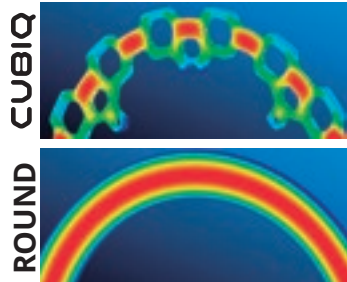

2 WEIGHT REDUCTION

Increasing the cooling surface optimizes the friction surface and enables a lighter brake track design.

**UP TO
40%
WEIGHT
OFF
CUBIQ
VS.
ROUND**

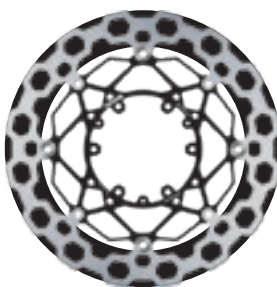

3 HOMOGENEOUS BRAKE PADS WEAR

The same contact surface between pad and disc during each turn generates a regular wear out of the brake pads and an homogeneous pressure.

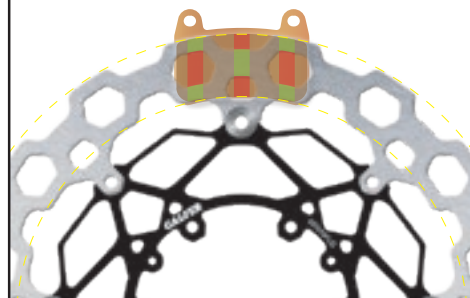

4 DYNAMIC UNBALANCE DECREASE

Having less unsprung mass reduces the gyroscopic effect and improves the maneuverability of the motorcycle.

5 STATE OF THE ART TECHNOLOGY

The CUBIQ brake track design is inspired in the latest modern designs and in contemporary elements.

6 NAMED AFTER THE STEEL MOLECULES

The origin of the CUBIQ name comes from the crystal molecules of the steel.

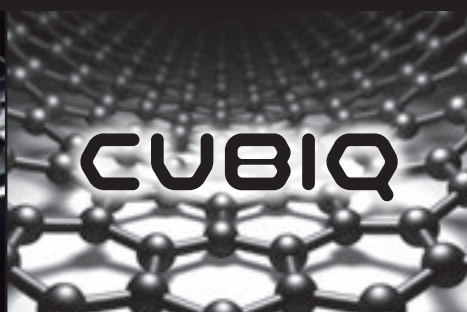

CUSTOM BRAKE PRODUCTS FOR V-TWIN MOTORCYCLES



CUSTOM CATALOGUE
Webiste download

DOWNLOAD THE CATALOGUE





GENERAL APPLICATIONS

APLICACIONES GENERALES

APPLICAZIONI GENERALI

APPLICATIONS GÉNÉRAL

(from year 1990)

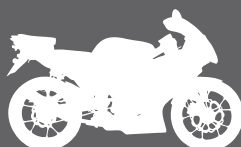
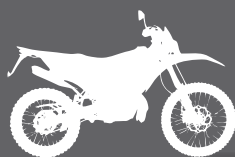

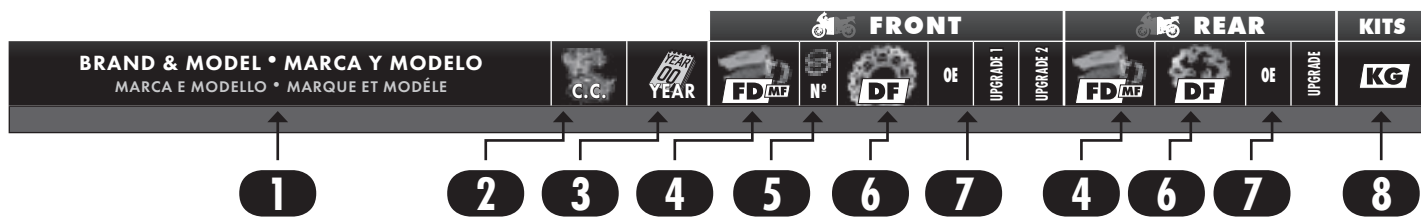

DESCRIPTION · DESCRIPCIÓN · DESCRIZIONE · DESCRIPTION

1

Brand and model of the motorcycle
Marca y modelo de la moto
 Marca e modello del motociclo
 Marque et modèle de la moto

2

Cylinder capacity of the motorcycle
Cilindrada de la moto
 Cilindrata del motociclo
 Cylindrée de la moto

3

Fabrication year of the motorcycle
Año de fabricación de la moto
 Anno di produzione del motociclo
 Année de fabrication de la moto

4

Brake pads or shoes reference
Referencia de las pastillas o mordazas de freno
 Riferimento pastiglie o ganasce freno
 Référence plaquettes ou mâchoires de frein

5

Number of front brake discs
Número de discos de freno delanteros
 Numero di dischi freno anteriori
 Nombre de disques de frein avant

6

Brake disc reference
Referencia del disco de freno
 Riferimento disco freno
 Référence disque de frein

7

Brake disc options (OE: original equipment / Upgrade: more performance)
Opciones del disco de freno (OE: equipo original / Upgrade: más prestaciones)
 Opzioni disco freno (OE: attrezzatura originale / Upgrade: maggiori prestazioni)
 Options disque de frein (OE: équipement original / Upgrade: plus de performance)

8

Brake kit reference
Referencia del kit de freno
 Riferimento kit freno
 Référence kit de frein



BRAND & MODEL · MARCA Y MODELO MARCA E MODELLO · MARQUE ET MODÉLE	C.C.	YEAR	FRONT						REAR				KITS KG	
			FD _{MF}	N°	DF	OE	UPGRADE 1	UPGRADE 2	FD _{MF}	DF	OE	UPGRADE		
ADIVA														
AD 125	125	09	FD188	1						FD220				
AD 250	250	09	FD220	1						FD220				
AD 400	400	09	FD220	1						FD220				
ADLY														
CAT 50	50	06	FD136	1						MF453	-			
JET 50	50	06	FD136	1						MF453	-			
MOTO FOX PLUS	50	02	FD094	1						MF453	-			
MOTO SILVER FOX	50	02	FD094	1						MF453	-			
NOBLE 50	50	05	FD094	1						MF453	-			
PANTHER 50	50	02	FD094	1						MF453	-			
PISTA 50	50	05	FD136	1						MF453	-			
ROAD RACER 50	50	04	FD136	1						MF453	-			
RS SUPERSONIC 50	50	06	FD094	1						FD094				
SILVER FOX 50	50	06	FD094	1						MF453	-			
THUNDER BIKE 50	50	06	FD094	1						MF453	-			
PISTA 70	70	05	FD136	1						MF453	-			
ROAD RACER 90	90	04	FD136	1						MF453	-			
CAT 100	100	06	FD136	1						MF453	-			
JET 100	100	06	FD136	1						MF453	-			
NOBLE 100	100	05	FD094	1						MF453	-			
PANTHER 100	100	02	FD094	1						MF453	-			
ROAD RACER 100	100	04	FD136	1						MF453	-			
SILVER FOX 100	100	06	FD094	1						MF453	-			
THUNDER BIKE 100	100	06	FD094	1						MF453	-			
CAT 125	125	06	FD136	1						MF453	-			
NOBLE 125	125	05	FD094	1						MF453	-			
SUPER SONIC 125 B	125	03	FD094	1						FD094				
THUNDER BIKE 125	125	06	FD094	1						FD094				
ADLY 4 Wheels														
CRUSADER QUAD 150	150	06	FD094	2						FD094				
INTERCEPTOR 150	150	06	FD094	2						FD094				
ATV 280 S	280	08	FD336	2						FD				
ATV 280 U	280	08	FD336	2						FD				
CRUSADER QUAD 300	300	06	FD094	2						FD094				
INTERCEPTOR 300	300	06	FD336	2						FD094				
320 4 VALVE 4X4	320	08	FD336	2						FD				
ATV 320 S	320	08	FD336	2						FD				
ATV 320 U	320	08	FD336	2						FD				
ATV 500 S	500	08	FD336	2						FD				
AEON														
AERO 50	50	06	FD094	1						MF	-			
NOX 50	50	06	FD094	1						MF	-			
REGAL 50	50	06	FD094	1						MF	-			
X FAST	50	04	FD136	1						MF	-			
AERO 100	100	06	FD094	1						MF	-			
NOX 100	100	06	FD094	1						MF	-			
PULSAR 100	100	06	FD094	1						MF	-			
X FAST	110	04	FD136	1						MF	-			
NOX 125	125	06	FD094	1						MF	-			
PULSAR 125	125	06	FD094	1						MF	-			
URBAN 125	125	11	FD187	1						FD094				
NOX 150	150	06	FD094	1						MF	-			
PULSAR 150	150	06	FD094	1						MF	-			
ELITE 200i	200	11	FD187	1						FD094				
URBAN 350i	350	11	FD187	1						FD094				
AEON 4 Wheels														
REVO R 50	50	03	MF		-					FD094				
REVO R 100	100	03	MF		-					FD094				
COBRA RS 125	125	03	MF		-					FD117				
OVERLAND 125	125	03	MF		-					FD117				
COBRA RS 180	180	03	MF		-					FD117				
OVERLAND 180	180	03	MF		-					FD117				
ROADSTER 180	180	03	MF		-					FD117				
COBRA 220	220	06	FD094	2						FD094				
OVERLAND 3.0	300	06	FD094	2						FD094				
CROSSLAND RX 350	350	11	FD094	2						FD117				
AJP														
PR 4 125 ENDURO	125	05	09	FD133	1	DF677	W	FLW	FLS	FD223	DF678	WLL	WS	
PR 4 125 ENDURO / PRO	125	10		FD162	1	DF677	W	FLW	FLS	FD252	DF678	WLL	WS	
PR 4 125 SM	125	05	09	FD133	1	DF677	W	FLW	FLS	FD223	DF678	WLL	WS	
PR 4 125 SM / PRO	125	10		FD162	1	DF677	W	FLW	FLS	FD252	DF678	WLL	WS	
MX 200	200	09		FD162	1					FD065				

APPLICATIONS

PADS FD

DISCS DF

SHOES MF

LINES FK

BRACKETS SP

KITS KG

CROSS REFERENCE





APPLICATIONS

PADS **FD**

DISCS **DF**

SHOES **MF**

LINES **FK**

BRACKETS **SP**

KITS **KG**

CROSS REFERENCE

BRAND & MODEL · MARCA Y MODELO MARCA E MODELLO · MARQUE ET MODÈLE	C.C.	YEAR	FRONT					REAR				KITS KG
			FD	N°	DF	OE	UPGRADE 1	UPGRADE 2	FD	DF	OE	
continue AJP												
PR 4 200 ENDURO / PRO	200	10	FD162	1	DF677	W	FLW	FLS	FD252	DF678	WLL	WS
PR 4 200 SM / PRO	200	10	FD162	1	DF677	W	FLW	FLS	FD252	DF678	WLL	WS
ENDURO 250	250	05	FD133	1	DF677	W	FLW	FLS	FD223	DF678	WLL	WS
PR 5 ENDURO 250	250	09	FD164	1					FD093			
PR 5 ENDURO 250	250	11	FD409	1					FD093			
PR 5 SUPERMOTO 250	250	09	FD164	1					FD093			
PR 5 SUPERMOTO 250	250	11	FD409	1					FD093			
AKT												
AK 100 S	100		FD095	1					MF	-		
AK 110 / SMART	110		FD073	1					MF	-		
SPECIAL 110	110	13	FD095	1					MF	-		
AK 125 DYNAMIC	125		FD188	1					MF	-		
AK 125 EVO	125		FD086	1					MF	-		
AK 125 FLEX	125		FD298	1					MF	-		
AK 125 JET 4	125		FD188	1					MF	-		
AK 125 NKD	125		FD086	1					MF	-		
AK 125 SL	125		FD073	1					MF	-		
AK 125 SPORT	125		FD073	1					MF	-		
AK 125 TT	125		FD117	1					MF	-		
EVO R3 125	125	15	FD073	1					MF	-		
FLEX 125	125	13	FD095	1					MF	-		
JET 4 R	125		FD188	1					MF	-		
NKD 125	125	11	FD073	1					FD095			
TTR 125	125	13	FD086	1					MF	-		
AK 150	150		FD086	1					MF	-		
AK 150 EVO	150		FD086	1					MF	-		
AK 150 TT	150		FD117	1					MF	-		
EVO R3 150	150	15	FD073	1					MF	-		
RTX 150	150		FD188	1					MF	-		
RTX UNISHOCK 150	150	15	FD073	1					FD095			
TTR 150	150	13	FD086	1					MF	-		
AK 180 XM XTREME MOTARD	180		FD095	1					FD187			
CR5 180	180	15	FD169	1					MF	-		
TTR 180	180	15	FD086	1					MF	-		
TTX 180	180	15	FD086	1					MF	-		
XM 180	180	11	FD086	1					FD095			
AK 200 XM	200		FD086	1					FD095			
AK 235 R	235		FD086	1					FD095			
AK 250 F RANCHERO	250		FD073	1					MF	-		
TT 250 ADVENTOUR	250	16	FD497	1	DF922				FD457	DF923		
ALFER												
125 VR 4T	125	03	FD138	1	DF606	W	FLW		FD165	DF607	W	WLL
125 VR 4T NO LIMITS	125	03	FD138	1	DF606	W	FLW		FD165	DF607	W	WLL
250 AR	250	92	FD089	1					FD075			
250 AR	250	93	FD138	1					FD075			
250 VR	250	94	FD138	1					FD075			
250 VR ENDURO	250	95	FD138	1	DF606	W	FLW		FD165	DF607	W	WLL
250 VR MOTOCROSS	250	95	FD138	1	DF606	W	FLW		FD165	DF607	W	WLL
NO LIMITS	250	95	FD138	1	DF606	W	FLW		FD165	DF607	W	WLL
300 TX	300	90	FD065	1					FD012			
ALPINA												
RENANIA VERONA 125	125	06	FD169	1					FD214			
AP LOCKHEED												
REAR CALIPER 2P (CP7003/4226/7-2S0)									FD356			
APRILIA												
AF1 50 FUTURA	50	90	FD084	1					FD048			
AMICO 50	50	90	MF630		-				MF630	-		
AMICO 50 GL,GLE,LX,SPORT LIFE,LX	50	92	FD153	1	DF466	W			MF630	-		
AREA 51	50	98	FD153	1					FD153	DF037	W	RW
CLASSIC 50	50	93	FD084	1					MF721	-		
COMPAY	50	02	FD153	1	DF629	W	RW	FLS	MF723	-		
EUROPA 50	50	91	FD084	1					FD048			
GULLIVER 50	50	95	FD153	1	DF629	W	RW	FLS	MF630	-		
GULLIVER 50 LC	50	96	FD153	1	DF629	W	RW	FLS	MF630	-		
HABANA	50	98	FD153	1	DF629	W	RW	FLS	MF723	-		
HABANA CUSTOM	50	98	FD153	1	DF629	W	RW	FLS	MF723	-		
Mc GULLIVER 50	50	98	FD153	1	DF629	W	RW	FLS	MF630	-		
MOJITO 50	50	02	FD153	1	DF629	W	RW	FLS	MF723	-		
MX SUPERMOTARD	50	02	FD162	1					FD048			
PEGASO 50	50	94	FD084	1					FD071			
RALLY 50	50	94	FD153	1	DF629	W	RW	FLS	MF630	-		
RALLY 50 LC	50	96	FD153	1	DF629	W	RW	FLS	FD153	DF629	W	RW



BRAND & MODEL · MARCA Y MODELO MARCA E MODELLO · MARQUE ET MODÈLE	C.C.	YEAR	FRONT					REAR				KITS KG	
			FD _{MF}	N°	DF	OE	UPGRADE 1	UPGRADE 2	FD _{MF}	DF	OE		UPGRADE
continue APRILIA													
RED ROSE 50	50	92	FD084	1						MF721	-		
RS 4 50	50	11	FD341	1						FD252			
RS 50	50	96 98	FD153	1						FD048			
RS 50	50	07	FD220	1						FD065			
RS 50 EXTREMA	50	94 95	FD171	1						FD048			
RS 50 REPLICA	50	99 06	FD162	1						FD048			
RS 50, ROSSI REPLICA	50	98 98	FD153	1						FD048			
RX 50	50	90 91	FD071	1						FD048			
RX 50	50	92 92	FD133	1						FD048			
RX 50	50	93	FD162	1						FD048			
SCARABEO 4 T	50	04	FD234	1	DF612	W				MF630	-		
SCARABEO 50	50	96 97	FD153	1	DF609	W				MF639	-		
SCARABEO de LUXE 50	50	98 01	FD153	1	DF612	W				FD153	DF629	W	RW
SCARABEO DITECH 50	50	02	FD153	1	DF612	W				FD228			
SONIC	50	98	FD153	1	DF466	W				MF630	-		
SONIC GP	50	98	FD153	1	DF466	W				MF630	-		
SPICE SONIC GP	50	98	FD153	1	DF466	W				MF630	-		
SPORT CITY ONE 50	50	08	FD074	1	DF612	W				MF	-		
SPORT CITY STREET 50	50	09	FD277	1						MF	-		
SR 50	50	93 93	FD153	1	DF629	W	RW	FLS		MF630	-		
SR 50 ACQUA	50	95 96	FD153	1	DF629	W	RW	FLS		MF630	-		
SR 50 EUROPA, URBAND KID, VIPER	50	94 94	FD171	1	DF629	W	RW	FLS		MF630	-		
SR 50 FACTORY	50	05	FD153	1	DF629	W	RW	FLS		FD228	DF648	W	RW
SR 50 R	50	05	FD153	1	DF629	W	RW	FLS		FD228	DF629	W	RW
SR 50 RACING CATALIZADA	50	00	FD232	1	DF629	W	RW	FLS		FD228	DF629	W	RW
SR 50 REPLICA	50	92 92	FD153	1	DF629	W	RW	FLS		MF630	-		
SR 50 REPLICA	50	93 93	FD170	1	DF629	W	RW	FLS		MF630	-		
SR 50 STEALTH	50	97 99	FD153	1	DF629	W	RW	FLS		FD153	DF629	W	RW
SR 50 URBAN	50	92 92	FD153	1	DF629	W	RW	FLS		MF630	-		
SR 50 VIPER	50	92 92	FD153	1	DF629	W	RW	FLS		MF630	-		
SR 50 VIPER	50	94 94	FD171	1	DF629	W	RW	FLS		MF630	-		
SR 50 WWW	50	97 99	FD153	1	DF629	W	RW	FLS		FD153	DF629	W	RW
TUAREG RALLY 50	50	90	FD071	1						FD048			
TUAREG WIND 50	50	90	FD071	1						MF	-		
TUONO 50	50	03	FD162	1						FD048			
SCARABEO 70	70	94	FD153	1	DF609	W				MF630	-		
CLASSIC 80	80	93	FD084	1						MF721	-		
SCARABEO 100	100	00 03	FD153	1	DF612	W				MF630	-		
SCARABEO 100 4T	100	04	FD234	1	DF612	W				MF630	-		
AF 1 125 FUTURA	125	90	FD118	1	DF660	CW				FD012			
ARRECIFE 125	125	03 05	FD245	1						FD228	DF648	W	RW
ARRECIFE 125 SPRINT	125	06	FD245	1						FD228	DF648	W	RW
ATLANTIC 125	125	03 05	FD245	1						FD228	DF648	W	RW
ATLANTIC 125 SPRINT	125	06	FD245	1						FD228	DF648	W	RW
COMPAY	125	03	FD153	1	DF629	W	RW	FLS		MF630	-		
EUROPA 125	125	91	FD118	1	DF660	CW				FD012			
HABANA	125	00 02	FD234	1	DF629	W	RW	FLS		MF	-		
HABANA CUSTOM	125	00 02	FD234	1	DF629	W	RW	FLS		MF	-		
LEONARDO 125 4T	125	96 98	FD153	1	DF612	W				FD153	DF629	W	RW
LEONARDO 125 4T	125	99	FD232	1	DF612	W				FD234	DF629	W	RW
MOJITO 125	125	05	FD153	1	DF629	W	RW	FLS		MF630	-		
MX 125	125	04	FD138	1	DF660	CW	CRW			FD135	DF632	W	
PEGASO 125	125	91 92	FD133	1	DF663	FLW				FD135	DF632	W	
PEGASO 125 KAT	125	93	FD118	1	DF663	FLW				FD170	DF632	W	
RED ROSE 125 AE	125	91	FD133	1						FD012			
RS 125	125	06 11	FD367	1	DF660	CW	CRW			FD228	DF669	W	
RS 125 EXTREMA, REPLICA	125	92 05	FD118	1	DF660	CW	CRW			FD170	DF669	W	
RS 4 125	125	11	FD341	1	DF860	W				FD252	DF861	W	
RX 125	125	91 91	FD089	1						FD135	DF887	W	
RX 125	125	92 92	FD133	1						FD075	DF887	W	
RX 125	125	95	FD162	1						FD135	DF887	W	
RX 125	125	08	FD138	1						FD135			
RX 125 (AJP)	125	08	FD138	1						FD252			
RX 125 C, CD	125	93 94	FD162	1						FD170	DF887	W	
SCARABEO 125 4T	125	98 04	FD074	1	DF671	W	FLW			FD228	DF609	W	
SCARABEO 125 4T	125	05	FD245	1	DF671	W	FLW			FD228			
SPORT CITY 125	125	04	FD074	1	DF671	W	FLW			FD228	DF612	W	
SPORT CITY ONE 125	125	08	FD074	1	DF612	W				MF	-		
SPORT PROT 125	125	92 94	FD118	1	DF660	CW	CRW			FD170			
SR 125	125	98	FD234	1	DF629	W	RW	FLS		MF	-		
SX 125	125	08	FD138	1						FD135			
TUAREG RALLY 125	125	91	FD133	1						FD135	DF887	W	

APPLICATIONS
 PADS FD
 DISCS DF
 SHOES MF
 LINES FK
 BRACKETS SP
 KITS KG
 CROSS REFERENCE



APPLICATIONS

PADS

DISCS

SHOES

LINES

BRACKETS

KITS

CROSS REFERENCE

BRAND & MODEL * MARCA Y MODELO MARCA E MODELLO * MARQUE ET MODÈLE	C.C.	YEAR	FRONT					REAR					KITS KG	
			FD	N°	DF	OE	UPGRADE 1	UPGRADE 2	FD	DF	OE	UPGRADE		
continue APRILIA														
TUONO 125	125	03	15	FD118	1	DF660	CW	CRW			FD153	DF669	W	
TUONO 125	125	16		FD341	1	DF660	CW	CRW			FD094	DF669	W	
LEONARDO 150 4T	150	98	98	FD153	1	DF612	W				FD153	DF629	W	RW
LEONARDO 150 4T	150	99		FD234	1	DF612	W				FD234	DF629	W	RW
SCARABEO 150 4T	150	98		FD074	1	DF671	W	FLW			FD228	DF612	W	
SR 150	150	00		FD234	1	DF629	W	RW	FLS		MF	-		
ARRECIFE 200	200	03		FD245	1						FD228	DF648	W	RW
ATLANTIC 200	200	03		FD245	1						FD228	DF648	W	RW
SCARABEO 200	200	07		FD245	1	DF671	W	FLW			FD228			
SCARABEO 200 / GT	200	02	06	FD074	1	DF671	W	FLW			FD228	DF612	W	
SPORT CITY 200	200	04		FD074	1	DF671	W	FLW			FD228	DF612	W	
ARRECIFE 250 SPRINT	250	06		FD245	1						FD228	DF648	W	RW
ATLANTIC 250 SPRINT	250	06		FD245	1						FD228	DF648	W	RW
CLIMBER 250	250	90	91	FD065	1						FD048			
CLIMBER 250 R	250	92		FD065	1						FD048			
LEONARDO 250 4T	250	99		FD074	1	DF612	W				FD228			
REPLICA 250	250	92		FD068	2						FD065			
RS 250	250	95	97	FD068	2						FD153	DF669	W	
RS 250	250	98		FD176	2						FD153	DF669	W	
SCARABEO 250	250	04	04	FD074	1	DF671	W	FLW			FD228	DF612	W	
SCARABEO 250 ie	250	05		FD245	1	DF671	W	FLW			FD228			
SPORT CITY 250	250	06		FD074	2	DF671	W	FLW			FD228	DF612	W	
CLIMBER 280 R	280	93		FD065	1						FD048			
ARRECIFE 300	300	10		FD245	1						FD228			
ATLANTIC 300	300	10		FD245	1						FD228			
LEONARDO 300	300	04		FD074	1	DF612	W				FD228			
SCARABEO 300 S	300	09		FD245	1	DF671	W	FLW			FD228			
SPORT CITY CUBE 300	300	08		FD074	2	DF671	W	FLW			FD228	DF612	W	
SR MAX 300	300	12		FD277	1	DF667	W				FD277	DF666	W	
ARRECIFE 400 SPRINT	400	07		FD245	1	DF671	W	FLW			FD228			
ATLANTIC 400 SPRINT	400	07		FD245	1	DF671	W	FLW			FD228			
SCARABEO 400 ie	400	07		FD074	2	DF671	W	FLW			FD228			
MXV 450	450	07		FD164	1						FD286			
RXV 450	450	06		FD164	1						FD286			
SXV 450	450	06		FD	1	DF826	CW	CRW			FD286	DF827	W	
ARRECIFE 500	500	02		FD074	2	DF671	W	FLW			FD228	DF612	W	
ARRECIFE 500 SPRINT	500	05		FD245	1	DF671	W	FLW			FD228	DF612	W	
ATLANTIC 500	500	02		FD074	2	DF671	W	FLW			FD228	DF612	W	
ATLANTIC 500 SPRINT	500	05		FD245	1	DF671	W	FLW			FD228	DF612	W	
SCARABEO 500	500	03		FD074	2	DF671	W	FLW			FD228			
SCARABEO 500 ABS++	500	03		FD074	2	DF671	W	FLW			FD228	DF612	W	
RXV 550	550	07		FD164	1						FD286			
SXV 550	550	06		FD	1	DF826	CW	CRW			FD286	DF827	W	
PEGASO 600 4 VALVOLE	600	91		FD128	1	DF663	FLW				FD075	DF632	W	
PEGASO 600 AE	600	91		FD133	1	DF663	FLW				FD135	DF632	W	
TUAREG 600 WIND AE	600	91		FD089	1	DF663	FLW				FD135			
MOTO 6.5	650	95		FD172	1						FD135	DF632	W	
PEGASO 650	650	91	93	FD132	1	DF663	FLW				FD135	DF632	W	
PEGASO 650	650	94	97	FD162	1	DF663	FLW				FD171	DF632	W	
PEGASO 650	650	98	00	FD172	1	DF663	FLW				FD075	DF632	W	
PEGASO 650 ie	650	01	06	FD172	1	DF663	FLW				FD165	DF703	W	
PEGASO 650 ie	650	07		FD176	1	DF660	CW	CRW			FD165	DF703	W	
PEGASO 650 ie FACTORY	650	06	08	FD	1	DF660	CW	CRW			FD165	DF703	W	
PEGASO 650 STRADA	650	05		FD176	1	DF660	CW	CRW			FD165	DF703	W	
RS 660	660	20		FD475	2	DF660	CW	CRW			FD165			
DORSODURO	750	08		FD367	2	DF660	CW	CRW			FD165			
DORSODURO FACTORY	750	10		FD367	2	DF660	CW	CRW			FD165			
SHIVER	750	07		FD367	2	DF660	CW	CRW			FD165			
SHIVER SL GT / ABS	750	09		FD367	2	DF660	CW	CRW			FD165			
MANA	850	07		FD367	2	DF660	CW	CRW			FD165			
MANA GT / ABS	850	09		FD367	2	DF660	CW	CRW			FD165			
MANA X / ABS	850	10		FD367	2	DF660	CW	CRW			FD165			
SRV 850	850	12		FD138	2						FD277			
DORSODURO 900	896	17		FD367	2	DF660	CW	CRW			FD165			
SHIVER 900	896	17		FD367	2	DF660	CW	CRW			FD165			
BLUE MARLIN	1000	02		FD176	2	DF660	CW	CRW			FD220	DF669	W	
CAPONORD RAID	1000	03		FD172	2						FD138			
ETV CAPONORD	1000	01		FD172	2						FD220			
PEGASO 1000	1000	01		FD172	2						FD165			
RST FUTURA	1000	01		FD176	2	DF472	FLW	FLV			FD138			
RSV MILLE	1000	98	00	FD176	2	DF660	CW	CRW			FD220	DF669	W	
RSV MILLE	1000	01		FD262	2	DF883	CW				FD220	DF669	W	



BRAND & MODEL · MARCA Y MODELO MARCA E MODELLO · MARQUE ET MODÈLE	C.C.	YEAR	FRONT						REAR				KITS KG	
			FD _{MF}	N°	DF	OE	UPGRADE 1	UPGRADE 2	FD _{MF}	DF	OE	UPGRADE		
continue APRILIA														
RSV MILLE R	1000	00	00	FD176	2	DF660	CW	CRW			FD220	DF669	W	
RSV MILLE R	1000	01		FD262	2	DF883	CW				FD220	DF669	W	
RSV MILLE SP	1000	00		FD176	2	DF660	CW	CRW			FD220	DF669	W	
RSV R FACTORY	1000	04		FD262	2	DF883	CW				FD220	DF669	W	
RSV TUONO	1000	02	05	FD176	2	DF660	CW	CRW			FD220	DF669	W	
RSV TUONO R	1000	02		FD262	2	DF883	CW				FD220	DF669	W	
RSV TUONO V4 R	1000	11		FD176	2	DF883	CW				FD220	DF669	W	
RSV4 FACTORY	1000	09		FD373	2	DF883	CW				FD220	DF669	W	
RSV4 R	1000	09	14	FD373	2	DF883	CW				FD220	DF669	W	
RSV4 RR	1000	15	16	FD373	2	DF883	CW				FD220	DF669	W	
RSV4 RR	1000	17		FD373	2	DF952	CW				FD220	DF669	WA	
RSV4 RR FW	1000	18	19	FD373	2	DF952	CW				FD220	DF669	WA	
RSV4 RR FW	1000	20		FD373	2	DF952	CW				FD181			
SL 1000 FALCO	1000	00		FD176	2	DF660	CW	CRW			FD220	DF669	W	
RSV TUONO V4 FACTORY	1100	17		FD373	2	DF952	CW				FD220	DF669	WA	
RSV TUONO V4 R	1100	15		FD475	2	DF883	CW				FD220	DF669	W	
RSV TUONO V4 RR	1100	17		FD373	2	DF952	CW				FD220	DF669	WA	
CAPONORD 1200	1200	13		FD475	2	DF883	CW				FD165			
DORSODURO 1200	1200	11		FD176	2	DF883	CW				FD165			
ARCTIC CAT 4 Wheels														
250 2X4/4X4 TODOS	250	98	04	FD302	2	DF723	W				FD302	DF723	W	
250 2X4/4X4 TODOS	250	05		FD353	2	DF723	W				FD353	DF723	W	
300 2X4/4X4 TODOS	300	98	04	FD302	2	DF723	W				FD302	DF723	W	
300 2X4	300	10		FD353	2	DF723	W				FD353	DF723	W	
300 4X4	300	05		FD353	2	DF723	W				FD353	DF723	W	
375 2X4/4X4 TODOS	375	98	04	FD302	2	DF723	W				FD302	DF723	W	
400 2X4/4X4 TODOS	400	98	04	FD302	2	DF723	W				FD302	DF723	W	
400 FI 5 4X4	400	05		FD353	2	DF723	W				FD353	DF723	W	
450 Hi	450	10		FD353	2	DF723	W				FD353	DF723	W	
454 2X4/4X4 TODOS	454	98	04	FD302	2	DF723	W				FD353	DF723	W	
500 2X4/4X4 TODOS	500	98	04	FD302	2	DF723	W				FD302	DF723	W	
500 FI 5	500	05		FD353	2	DF723	W				FD353	DF723	W	
500 TRV	500	05		FD353	2	DF723	W				FD353	DF723	W	
650 4X4	650	05		FD353	2	DF723	W				FD353	DF723	W	
650 H1 4X4	650	05		FD353	2	DF723	W				FD353	DF723	W	
650 PROWLER XT	650	05		FD353	2	DF723	W				FD353	DF723	W	
650 TRV	650	09		FD353	2	DF723	W				FD353	DF723	W	
700 DIESEL TRV	700	06		FD353	2	DF723	W				FD353	DF723	W	
700 H1 TRV	700	09		FD353	2	DF723	W				FD353	DF723	W	
700 SUPER DUTY DIESEL	700	10		FD353	2	DF723	W				FD353	DF723	W	
1000 THUNDERCAT	1000	08		FD353	2	DF723	W				FD353	DF723	W	
1000 H2 TRV	1000	09		FD353	2	DF723	W				FD353	DF723	W	
1000 WILDCAT 1000i H.D.	1000	12		FD353	2						FD353			
ARCTIC CAT SNOW														
WILLWOOD BRAKES TODOS		01									FD182			
COGUAR DE LUXE		98									FD182			
POWDER EXT		95	98								FD182			
THUNDERCAT		93	00								FD182			
JAG 440 Z	440	95	97								FD182			
ZL 440	440	97	00								FD182			
ZR 440	440	93	00								FD182			
POWDER 500 SPECIAL	500	98	00								FD182			
ZL 500 EFI	500	98	00								FD182			
ZR 500 EFI	500	95	00								FD182			
ETX 580 EFI - MC	580	95	98								FD182			
PANTERA	580	95	98								FD182			
POWDER 580 SPECIAL	580	97	98								FD182			
ZR 580	580	93	00								FD182			
ETX 600 TRIPLE	600	97	00								FD182			
POWDER 600 SPECIAL EFI	600	97	00								FD182			
ZL 600 EFI	600	98	00								FD182			
ZR 600 EFI	600	98	00								FD182			
ZRT 600	600	96	00								FD182			
POWDER 700 SPECIAL EFI	600	99	00								FD182			
WILDCAT 700 EFI	700	95	96								FD182			
ZR 700	700	94	00								FD182			
PANTERA 800	800	98	99								FD182			
ZRT 800	800	96	00								FD182			
ATALA														
MASTER 4	50	94		FD071	1						MF	-		
BYTE	50	99		FD153	1	DF466	W				MF	-		
CAROSSELLO	50	99		FD084	1	DF609	W				MF	-		

APPLICATIONS
 PADS FD
 DISCS DF
 SHOES MF
 LINES FK
 BRACKETS SP
 KITS KG
 CROSS REFERENCE





APPLICATIONS

PADS FD

DISCS DF

SHOES MF

LINES FK

BRACKETS SP

KITS KG

CROSS REFERENCE

BRAND & MODEL * MARCA Y MODELO MARCA E MODELLO * MARQUE ET MODÈLE	C.C.	YEAR	FRONT					REAR				KITS KG
			FD _{MF}	N°	DF	OE	UPGRADE 1	UPGRADE 2	FD _{MF}	DF	OE	
continue ATALA												
HACKER AT 12	50	99	FD153	1	DF649	W			MF	-		
HACKER LC	50	99	FD153	1	DF649	W			MF	-		
SKEGGIA	50	99	FD153	1	DF649	W			MF	-		
ATK												
BULL 50	50	94	FD086	1					FD086			
BULLET 50 CN N	50	94	FD086	1					FD086			
COBRA 50	50	94	FD086	1					FD086			
TODOS MODELOS		92 93	FD085	1					FD012			
TODOS MODELOS		93 96	FD086	1					FD086			
TODOS MODELOS		97	FD138	1					FD165			
BAJAJ												
DISCOVER 125	125	14	FD145	1					MF	-		
DISCOVER S 125	125	14	FD138	1					MF	-		
DISCOVER ST	125	13	FD138	1					MF	-		
XDC 125	125	14	FD138	1					MF	-		
DISCOVER 135	135		FD138	1					MF	-		
PULSAR 135 LS	135	12	FD138	1					MF	-		
AVENGER STREET	150	15	FD138	1					MF	-		
DISCOVER 150 F	150	17	FD138	1					MF	-		
DISCOVER 150 M	150	14	FD138	1					MF	-		
DISCOVER 150 S	150	17	FD138	1					MF	-		
PULSAR 150	150	17	FD138	1					MF	-		
PULSAR 150 R	150	19	FD138	1					FD165			
V 150	150	16	FD138	1					MF	-		
PULSAR 160 NS F	160	19	FD138	1					MF	-		
PULSAR 160 NS TD	160	19	FD138	1					FD165			
PULSAR 180	180		FD138	1					MF	-		
PULSAR 180 BLACKTEC	180		FD138	1					MF	-		
PULSAR 180 UG	180		FD138	1					MF	-		
PULSAR 200	200	15	FD138	1					MF	-		
PULSAR 200 ADVENTURE	200	15	FD138	1					FD165			
PULSAR 200 NS	200	17	FD138	1					FD165			
PULSAR 200 RS	200	17	FD138	1					FD165			
AVENGER CRUISE DTS	220	15	FD145	1					MF	-		
AVENGER STREET	220	15	FD145	1					MF	-		
PULSAR 220 F	220		FD138	1					FD165			
PULSAR 220 S	220		FD138	1					FD165			
DOMINAR 400	400	17	FD138	1					FD165			
BAROSSA 4 Wheels												
PYTHON 50	50	04	MF		-				FD187			
PYTHON 100	100	04	MF		-				FD187			
150 CHEETAH	150	03	MF		-				FD187			
150 MAGNA	150	03	MF		-				FD187			
170 CHEETAH	170	03	MF		-				FD187			
170 MAGNA	170	03	MF		-				FD187			
BENELLI												
49 X	50	07	FD175	1					MF	-		
BUNNY 50	50	95	FD079	1					MF	-		
DEVIL 50	50	95	FD085	1					FD071			
GT 491	50	98	FD153	1	DF649	W			MF	-		
K 2	50	98	FD153	1	DF649	W			MF	-		
K 2 LIQUID	50	98	FD153	1	DF649	W			MF	-		
K 2 NAMUR	50	98	FD153	1	DF649	W			MF	-		
MALA 50	50	13	FD153	1					MF	-		
MASTER 4 50	50	95	FD071	1					MF	-		
NAKED 50	50	98	FD153	1	DF649	W			MF	-		
PEPE	50	98	FD153	1					MF	-		
QUATTRO NOVE X	50	09	FD095	1					MF	-		
RACING 491	50	98	FD153	1	DF649	W			FD200	DF649	W	
SPORT 491	50	98	FD153	1	DF649	W			MF	-		
SPRING 50	50	95	FD085	1					FD071			
SUPERBIKE 491	50	98	FD153	1	DF649	W			FD200	DF649	W	
DEVIL 80	80	95	FD085	1					FD071			
K 2 BIPOSTO	100	98	FD153	1	DF649	W			MF	-		
666	125	98	FD068	1					FD220			
ADIVA	125	00	FD153	1	DF737	W			FD263			
CIVITAS 125	125	20	FD073	1					FD165			
HOBBY 125	125	13	FD187	1					FD187			
MACIS 125	125	08	FD187	1					FD187			
TORNADO NAKET 125	125	18	FD	1					FD500			
VELVET 125	125	98 10	FD153	1	DF669	W			FD153	DF649	W	
VELVET 125	125	11	FD162	1					FD153			



BRAND & MODEL · MARCA Y MODELO MARCA E MODELLO · MARQUE ET MODÈLE	C.C.	YEAR	FRONT					REAR				KITS KG	
			FD _{MF}	N°	DF	OE	UPGRADE 1	UPGRADE 2	FD _{MF}	DF	OE		UPGRADE
continue BENELLI													
ADIVA	150	00	FD153	1	DF737	W				FD263			
HOBBY 150	150	13	FD187	1						FD187			
MACIS 150	150	10	FD187	1						FD187			
UNO C 150	150	13	FD176	1						FD012			
VELVET 150	150	98	FD153	1	DF669	W				FD153	DF649	W	
TNT 200	200	17	FD538	1						FD500			
251 S	250	20	FD538	1						FD345			
BN 251	250	14	FD538	1						FD345			
CAFFE NERO DER.	250	08	FD187	1						FD315			
CAFFE NERO IZQ.	250	08	FD145	1									
LEONCIO 250	250	18	FD538	1						FD345			
TRK 251	250	18	FD538	1						FD345			
UNO C 250	250	13	FD176	1						FD012			
VELVET 250	250	99	FD162	1	DF669	W				FD228	DF649	W	
TNT 300	300	16	FD538	2						FD345			
302 R	302	17	FD538	2						FD345			
302 S	302	18	FD538	2						FD345			
BN 302	302	14	FD538	2						FD214			
TRK 302	302	20	FD538	2						FD345			
402 S	400	18	FD538	2						FD345			
IMPERIALE 400	400	18	FD176	1						FD345			
VELVET DUSK 400	400	03	FD162	1						FD228	DF649	W	
BX 449	449	07	FD138	1	DF862	FLW				FD291	DF632	W	
LEONCIO	500	17	FD262	2	DF660	CW	CRW			FD345			
LEONCIO CINQUECENTO	500	18	FD262	2	DF660	CW	CRW			FD345			
LEONCIO TRAIL	500	17	FD266	2	DF660	CW	CRW			FD345			
TRK 502	500	17	FD262	2	DF660	CW	CRW			FD165	DF736		
TRK 502 X	500	17	FD266	2	DF660	CW	CRW			FD345	DF736		
TRX 502	500	18	FD172	2	DF660	CW	CRW			FD345			
502 C	502	19	FD475	2						FD220			
510 ENDURO	510	08	FD138	1	DF862	FLW				FD165	DF632	W	
570 SUPERMOTO	570	08	FD262	1	DF886					FD165	DF632	W	
BN 600	600	13	FD176	2	DF660	CW	CRW			FD220			
BN 600 GT	600	15	FD475	2	DF660	CW	CRW			FD220			
BN 600 R	600	14	FD475	2	DF660	CW	CRW			FD220			
756	750	10	FD176	2						FD220			
752 S	750	18	19	FD262	2	DF660	CW	CRW		FD345			
752 S	750	20	FD475	2	DF660	CW	CRW			FD345			
DUE	750	07	FD262	2						FD220			
LEONCINO 800	800	20	FD475	2	DF660	CW	CRW			FD220			
LEONCINO 800 TRAIL	800	20	FD475	2	DF660	CW	CRW			FD220			
CENTURY RACER 899	900	11	FD262	2	DF660	CW	CRW			FD220	DF703	W	
TNT 899	900	11	FD262	2	DF660	CW	CRW			FD220			
TNT 899 S/T	900	08	10	FD176	2	DF660	CW	CRW		FD220			
TORNADO TRE 900 LM	900	03	FD262	2	DF660	CW	CRW			FD220			
TRE-K 899	900	09	FD176	2	DF660	CW	CRW			FD220	DF703	W	
SPORT TORNADO NAKED TRE	1130	06	FD262	2	DF881	CW	FLW	CRW		FD220	DF736	W	
TNT 1130	1130	04	FD176	2	DF660	CW	CRW			FD220	DF703	W	
TNT CAFÉ RACER	1130	06	FD262	2	DF660	CW	CRW			FD220	DF703	W	
TNT R 160	1130	10	FD262	2	DF660	CW	CRW			FD220	DF703	W	
TNT TITANIUM	1130	06	FD262	2	DF660	CW	CRW			FD220	DF703	W	
TORNADO TRE 1130	1130	06	FD262	2	DF881	CW	FLW	CRW		FD220	DF736	W	
TREK AMAZONAS	1130	07	FD176	2	DF881	CW	FLW	CRW		FD220	DF736	W	
BETA													
ALP 50	50	94	FD065	1						FD102			
AR-T	50	03	04	FD162	1	DF674	W	FLW		FD065	DF675	W	
AR-T	50	05	FD162	1	DF744	W				FD223	DF745	W	
ARK 50	50	96	96	FD153	1					MF	-		
ARK 50 LC - R	50	97	FD153	1	DF649	W				FD153	DF649	W	
CHRONO 50	50	94	FD153	1	DF629	W	RW	FLS		MF630	-		
EIKON	50	99	FD065	1	DF649	W				FD065	DF649	W	
MINI TRIAL 50	50	09	FD224	1						FD224			
MX 50	50	92	FD084	1						FD084			
MX 50 ENDURO	50	92	FD065	1	DF645	CW				FD065			
QUADRA	50	94	FD153	1	DF649	W				MF630	-		
RK6 50	50	94	98	FD133	1					FD065	DF654		
RK6T 50	50	99	01	FD065	1	DF658	W			FD065			
RK6T 50 SUPERMOTARD	50	99	01	FD065	1	DF658	W			FD065			
RR ENDURO	50	08	FD162	1						FD456			
RR MOTARD	50	08	FD162	1						FD456			
RR-T	50	99	01	FD133	1	DF658	W			FD065			
RR-T	50	02	04	FD065	1					FD065			



APPLICATIONS
 PADS FD
 DISCS DF
 SHOES MF
 LINES FK
 BRACKETS SP
 KITS KG
 CROSS REFERENCE



APPLICATIONS

PADS FD

DISCS DF

SHOES MF

LINES FK

BRACKETS SP

KITS KG

CROSS REFERENCE

BRAND & MODEL * MARCA Y MODELO MARCA E MODELLO * MARQUE ET MODÈLE	C.C.	YEAR	FRONT					REAR				KITS KG	
			FD _{MF}	N°	DF	OE	UPGRADE 1	UPGRADE 2	FD _{MF}	DF	OE		UPGRADE
continue BETA													
RR-T	50	05	FD065	1						FD065			
ST 50	50	94	FD065	1						FD102			
TEMPO 50	50	94	FD084	1	DF629	W	RW	FLS		MF630	-		
ZERO 50	50	94	FD065	1						FD102			
EVO 80 JUNIOR	80	09	FD223	1	DF804	W				FD335			
REV 3	80	00	07	FD065	1					FD065			
REV 3	80	08	FD223	1						FD335			
ALP 125	125	06	07	FD162	1					FD093			
ALP 125	125	08	FD162	1						FD456			
EIKON 125 4T	125	99	FD153	1	DF612	W				FD153			
EVO 125	125	09	11	FD223	1	DF818	W			FD428	DF819	W	
EVO 125 MY12	125	12	FD223	1	DF818	W				FD428	DF819	W	
JONATHAN	125	00	FD068	1						FD165			
REV 3	125	00	04	FD223	1					FD223			
REV 3	125	05	05	FD223	1	DF818	W			FD223	DF805	W	
REV 3	125	06	FD223	1	DF818	W				FD335	DF805	W	
RR 125 4T	125	06	FD162	1						FD456			
RR 125 4T SM	125	06	FD162	1						FD456			
RR ENDURO	125	08	FD162	1						FD456			
RR MOTARD	125	08	FD162	1						FD456			
SYNT 125	125	94	FD065	1						FD151	DF643		
TR 35 125	125	91	FD065	1						FD102			
URBAN 125	125	08	FD162	1						FD456			
ZERO 125	125	92	FD065	1						FD102			
EIKON 150 4T	150	99	FD153	1						FD228			
200 ALP	200	00	07	FD065	1					FD065			
200 ALP	200	08	FD162	1						FD456			
EVO 200	200	09	11	FD223	1	DF818	W			FD428	DF819	W	
EVO 200 MY12	200	12	FD223	1	DF818	W				FD428	DF819	W	
REV 3	200	06	FD223	1	DF818	W				FD335	DF805	W	
URBAN 200	200	08	FD162	1						FD456			
240 ST	240	92	FD065	1	DF804	W				FD102			
250 RR 2T ENDURO	250	12	FD164	1	DF814	W				FD456	DF815	W	RW
250 RR 4T	250	05	FD164	1	DF635	FLW	FLS	FRS		FD456	DF670	W	PW
EVO 250 2T	250	09	11	FD223	1	DF818	W			FD428	DF819	W	
EVO 250 2T MY12	250	12	FD223	1	DF818	W				FD428	DF819	W	
EVO 250 4T	250	09	11	FD223	1	DF818	W			FD428	DF819	W	
EVO 250 4T MY12	250	12	FD223	1	DF818	W				FD428	DF819	W	
REV 3	250	00	04	FD223	1					FD223			
REV 3	250	05	05	FD223	1	DF818	W			FD224	DF805	W	
REV 3	250	06	FD223	1	DF818	W				FD335	DF805	W	
REV 4T	250	07	FD223	1	DF818	W				FD335	DF805	W	
TECHNO 250	250	94	FD065	1	DF804	W				FD151	DF643	W	
X-TRAINER	250	18	FD164	1	DF814	W				FD286	DF815	W	
SYNT 260	260	92	93	FD065	1	DF804	W			FD102			
SYNT 260	260	94	FD065	1	DF804	W				FD151	DF643		
ZERO	260	98	FD065	1	DF804	W				FD065			
ZERO 93 GARA	260	93	97	FD065	1	DF804	W			FD159			
REV 3	270	05	FD223	1	DF818	W				FD335	DF805	W	
EVO 290 2T	290	09	FD223	1	DF818	W				FD428	DF819	W	
300 RR 2T ENDURO	300	13	FD164	1	DF814	W				FD456	DF815	W	RW
EVO 300 2T MY12	300	12	FD223	1	DF818	W				FD428	DF819	W	
EVO 300 4T	300	09	FD223	1	DF818	W				FD428	DF819	W	
EVO 300 4T MY12	300	12	FD223	1	DF818	W				FD428	DF819	W	
XTRAINER	300	15	FD164	1	DF814	W				FD456	DF815	W	RW
350 RR 4T	350	11	12	FD164	1	DF635	FLW	FLS	FRS	FD456	DF670	W	PW
350 RR 4T ENDURO	350	13	FD164	1	DF814	W				FD456	DF815	W	RW
350 RR efi	350	15	FD164	1	DF814	W				FD456	DF815	W	RW
ALP 4.0	350	03	07	FD162	1	DF677	W	FLW	FLS	FD075	DF678	WLL	WS
ALP 4.0	350	08	FD162	1						FD456			
EURO	350	00	FD068	1						FD165			
JONATHAN	350	03	FD068	1						FD165			
M 4	350	06	FD337	1						FD093			
MOTARD 4.0	350	05	06	FD337	1					FD075			
MOTARD 4.0	350	07	FD337	1						FD456			
390 RR 4T	390	15	FD164	1	DF814	W				FD456	DF815	W	RW
400 RR 4T	400	05	12	FD164	1	DF635	FLW	FLS	FRS	FD456	DF670	W	PW
400 RR 4T ENDURO	400	13	FD164	1	DF814	W				FD456	DF815	W	RW
430 RR 4T	430	15	FD164	1	DF814	W				FD456	DF815	W	RW
450 RR 4T	450	05	12	FD164	1	DF635	FLW	FLS	FRS	FD456	DF670	W	PW
450 RR 4T ENDURO	450	13	FD164	1	DF814	W				FD456	DF815	W	RW
480 RR 4T	480	15	FD164	1	DF814	W				FD456	DF815	W	RW



BRAND & MODEL · MARCA Y MODELO MARCA E MODELLO · MARQUE ET MODÈLE	C.C.	YEAR	FRONT					REAR				KITS KG	
			FD MF	N°	DF	OE	UPGRADE 1	UPGRADE 2	FD MF	DF	OE		UPGRADE
continue BETA													
498 RR 4T	498	12	12	FD164	1	DF635	FLW	FLS	FRS	FD456	DF670	W	PW
498 RR 4T ENDURO	498	13		FD164	1	DF814	W			FD456	DF815	W	RW
525 RR 4T	525	05		FD164	1	DF635	FLW	FLS	FRS	FD456	DF670	W	PW
BIMOTA													
V-DUE 500	500	98		FD068	2	DF660	CW	CRW		FD012			
V-DUE 500 EVOLUZIONE	500	00		FD176	2	DF660	CW	CRW		FD012			
BELLARIA	600	90		FD068	2					FD012			
YB9 SUPERSPORT 600	600	93		FD068	2	DF660	CW	CRW		FD012			
BB1 SUPERMONO	650	95		FD068	1	DF660	CW	CRW		FD012			
SB 6 750	750	94		FD068	2					FD012			
TESI 1D 851	851	90	91	FD068	2	DF660	CW	CRW		FD012			
MANTRA 900	900	95		FD068	2	DF660	CW	CRW		FD012			
DB4	900	98	99	FD176	2	DF660	CW	CRW		FD012			
DB2 H.F, SR, INJECTION	904	93		FD068	2	DF660	CW	CRW		FD012			
TESI 1D 906 SR, ES, EF	904	93		FD068	2					FD012			
DB 5 R / S	990	10		FD262	2					FD220			
DB 6 / R	990	10		FD262	2					FD220			
DB5 MILLE	992	05		FD262	2	DF883	CW			FD220			
TESI 2D	992	06		FD068	2					FD012			
SB8 K SANTAMONICA	996	06		FD262	2	DF883	CW			FD012			
SB8 R SPECIAL	996	97		FD068	2	DF660	CW	CRW		FD012			
BB3	1000	14		FD373	2					FD			
DELIRIO	1000	07		FD262	2					FD220			
DIECI	1000	91		FD068	2					FD012			
DIECI BIPOSTO	1000	92	95	FD068	2	DF660	CW	CRW		FD012			
TESI 2D	1000	05		FD068	2					FD012			
TESI 3D	1000	07		FD262	2					FD220			
YB10 BIPOSTO	1000	93		FD068	2					FD012			
YB8	1000	90		FD068	2					FD012			
YB8 EVOLUTION	1000	93		FD068	2					FD012			
YB8 EXUP	1000	91		FD068	2					FD012			
YB8 FURANO 1000	1000	92		FD068	2					FD012			
DB 6 RE / E	1100	12		FD262	2					FD220			
DB 7	1100	08	08	FD262	2	DF660	CW	CRW		FD220			
DB 7	1100	09		FD373	2					FD220			
DB 10	1100	12		FD262	2					FD220			
DBx	1100	13		FD172	2					FD172			
SB6	1100	98		FD068	2	DF660	CW	CRW		FD012			
SB7 1100	1100	94		FD068	2					FD012			
TESI 3D	1100	08		FD262	2					FD220			
TUATARA 1100	1100	90		FD068	2					FD012			
DB 8	1198	10		FD373	2					FD220			
DB 8 SP	1198	13		FD373	2					FD220			
DB 11 / VLX	1198	13		FD373	2					FD220			
DB 12 B.TOURIST	1198	13		FD262	2					FD220			
BLANEY 4 Wheels													
XC 125 TROJAN	125	03		MF		-				FD073			
XL 200 TROOPER	200	03		MF		-				FD117			
BLATA													
ENDURO 125	125	07		FD341	1					FD065			
MOTARD 125	125	07		FD341	1					FD065			
BMW													
C EVOLUTION	EL	14		FD266	1	DF816	W	FLW		FD266	DF816	W	FLW
C1 125	125	00		FD172	1					FD165			
C1 200	200	01		FD172	1					FD165			
G 310 GS	310	17		FD450	1	DF800	CW			FD165	DF075	W	
G 310 R	310	16		FD450	1	DF800	CW			FD165	DF075	W	
C 400 GT	400	19		FD450	2					FD165			
C 400 X	400	18		FD450	2					FD165			
G 450 X	450	08		FD138	1	DF710	FLW	FLS	FRS	FD291	DF711	W	WLL
SPORT ENDURO 450	450	08		FD138	1	DF710	FLW	FLS	FRS	FD291	DF711	W	WLL
C 600 SPORT	600	12		FD266	2	DF816	W	FLW		FD266	DF816	W	FLW
C 650 GT	650	12		FD266	2	DF816	W	FLW		FD266	DF816	W	FLW
C 650 MOTORSPORT	650	19		FD266	2	DF816	W	FLW		FD266	DF816	W	FLW
F 650	650	93		FD172	1	DF663	FLW			FD165	DF703	W	
F 650 CS SCARVER	650	01		FD172	1	DF663	FLW			FD165	DF703	W	
F 650 DAKAR	650	00	01	FD172	1	DF663	FLW			FD165	DF703	W	
F 650 GS	650	00		FD172	1	DF663	FLW			FD165	DF703	W	
F 650 GS BICILINDRICO	650	07		FD172	1	DF663	FLW			FD165	DF763	W	
F 650 ST	650	97		FD172	1	DF663	FLW			FD165	DF703	W	
G 650 GS	650	09		FD172	1	DF663	FLW			FD165	DF703	W	
G 650 XCHALLENGE	650	07		FD172	1	DF663	FLW			FD165	DF703	W	





APPLICATIONS

PADS FD

DISCS DF

SHOES MF

LINES FK

BRACKETS SP

KITS KG

CROSS REFERENCE

BRAND & MODEL · MARCA Y MODELO MARCA E MODELLO · MARQUE ET MODÈLE	C.C.	YEAR	FRONT					REAR				KITS
			FD	N°	DF	OE	UPGRADE 1	UPGRADE 2	FD	DF	OE	
continue BMW												
G 650 XCOUNTRY	650	07	FD172	1	DF663	FLW			FD165	DF703	W	
G 650 XMOTO	650	07	FD176	1	DF883	CW			FD165			
R 65 R	650	93	FD044	1					MF610	-		
F 700 GS	700	13	FD172	2	DF664	CW			FD165	DF763	W	
F 750 GS	750	18	FD172	2	DF702	W			FD165	DF763	W	
K 75	750	93	FD013	2	DF662	W			FD013	DF662	W	
K 75 RT, S	750	93	FD013	2	DF662	W			FD044	DF662	W	
F 800 GS	800	08	FD172	2	DF664	CW			FD165	DF763	W	
F 800 GT	800	13	FD176	2	DF707	W			FD165	DF763	W	
F 800 R	800	09	FD176	2	DF707	W			FD165	DF763	W	
F 800 R	800	15	FD475	2	DF707	W			FD165	DF763	W	
F 800 S	800	06	FD176	2	DF707	W			FD165	DF763	W	
F 800 ST	800	06	FD176	2	DF707	W			FD165	DF763	W	
R 80 GS	800	93	FD044	1	DF662	W			MF610	-		
R 80 R	800	94	FD198	2					MF	-		
R 80 R ROADSTER	800	93	FD198	2					MF	-		
R 80 RT	800	93	FD044	2	DF662	W			MF	-		
RT 80 RT	800	91	FD044	1					MF	-		
F 850 GS	850	18	FD172	2	DF702	W			FD165	DF763	W	
R 850 R	850	04	FD272	2	DF707	W			FD186	DF701	W	
R 850 R ROADSTER	850	95	FD198	2	DF631	CW			FD186	DF701	W	
R 850 R ROADSTER	850	01	FD271	2	DF631	CW			FD186	DF701	W	
R 850 RT	850	06	FD271	2	DF707	W			FD186	DF701	W	
F 900 R	900	20	FD475	2	DF707	W			FD165	DF763	W	
F 900 XR	900	20	FD475	2	DF707	W			FD165	DF763	W	
F 900 XR SPORT	900	20	FD475	2	DF707	W			FD165	DF763	W	
HP 4	1000	12	FD373	2	DF817	CW			FD165	DF756	W	
HP 4 RACE	1000	18	FD373	2	DF817	CW			FD165	DF756	W	
R 100 GS, PD, RT	1000	93	FD044	1	DF662	W			MF610	-		
R 100 GS, R	1000	93	FD198	2	DF631	CW			FD013	DF662	W	
R 100 GS/ABS, R, RS	1000	95	FD198	2	DF702	W			FD186	DF701	W	
R 100 R	1000	92	FD137	2	DF662	W			MF	-		
R 100 R CLASSIC, MYSTIC	1000	95	FD198	2	DF662	W			FD186	DF701	W	
R 100 ROADSTER	1000	93	FD198	2	DF662	W			MF	-		
S 1000 R NAKED	1000	14	FD437	2	DF755	CW			FD165	DF756	W	
S 1000 R NAKED	1000	20	FD475	2	DF707	W			FD165	DF756	W	
S 1000 RR	1000	09	FD437	2	DF755	CW			FD165	DF756	W	
S 1000 RR ABS	1000	09	FD437	2	DF755	CW			FD165	DF756	W	
S 1000 RR ABS	1000	19	FD537	2	DF817	CW			FD165	DF756	W	
S 1000 XR	1000	15	FD475	2	DF755	CW			FD186	DF763	W	
S 1000 XR	1000	20	FD537	2	DF755	CW			FD186	DF763	W	
S 1000 XR M	1000	20	FD537	2	DF817	CW			FD186	DF763	W	
K 1100 RS ABS	1100	93	FD198	2	DF631	CW			FD013	DF662	W	
K 1100 LT SPECIAL EDITION	1100	95	FD198	2	DF631	CW			FD044	DF662	W	
K 1100 LT (ABS)	1100	93	FD198	2	DF631	CW			FD013	DF662	W	
R 1100 GS ABS	1100	94	FD198	2	DF702	W			FD186	DF701	W	
R 1100 GS NO ABS	1100	94	FD198	2	DF702	W			FD186	DF701	W	
R 1100 LT	1100	95	FD198	2	DF631	CW			FD013	DF662	W	
R 1100 R ROADSTER	1100	95	FD198	2	DF631	CW			FD186	DF701	W	
R 1100 RS	1100	93	FD198	2	DF631	CW			FD013	DF662	W	
R 1100 RS NO ABS	1100	95	FD198	2	DF631	CW			FD186	DF701	W	
R 1100 RT ABS	1100	94	FD198	2	DF631	CW			FD186	DF701	W	
R 1100 RT NO ABS	1100	94	FD198	2	DF631	CW			FD186	DF701	W	
R 1100 S NO ABS	1100	98	FD198	2	DF702	W			FD186	DF701	W	
R 1100 S	1100	01	FD271	2	DF707	W			FD186	DF701	W	
R 1100 S ABS	1100	01	FD272	2	DF707	W			FD186	DF701	W	
HP 2 ENDURO	1150	05	FD172	1	DF702	W			FD186	DF763	W	
HP 2 SM	1150	06	FD172	1	DF707	W			FD186	DF763	W	
HP 2 SPORT	1150	08	FD373	2	DF707	W			FD186	DF763	W	
HP 2 MEGAMOTO	1150	07	FD271	2	DF707	W			FD186	DF763	W	
R 1150 GS ABS	1150	00	FD198	2	DF702	W			FD186	DF701	W	
R 1150 GS	1150	02	FD271	2	DF702	W			FD186	DF701	W	KG702
R 1150 GS ADVENTURE	1150	03	FD272	2	DF707	W			FD186	DF701	W	
R 1150 R ROCKESTER	1150	03	FD272	2	DF707	W			FD186	DF701	W	
R 1150 R ROADSTER	1150	01	FD272	2	DF707	W			FD186	DF701	W	
R 1150 RS	1150	01	FD272	2	DF707	W			FD186	DF701	W	
R 1150 RT	1150	01	FD271	2	DF707	W			FD186	DF701	W	
K 1200 GT	1200	02	FD271	2	DF707	W			FD013	DF662	W	
K 1200 GT DER/RIGHT	1200	06	FD	2	DF707	W			FD			
K 1200 GT IZQ/LEFT	1200	06	FD271	2	DF707	W						
K 1200 LT	1200	97	FD198	2	DF702	W			FD251			
K 1200 LT	1200	01	FD272	2	DF707	W			FD251			



BRAND & MODEL · MARCA Y MODELO MARCA E MODELLO · MARQUE ET MODÈLE	C.C.	YEAR	FRONT					REAR				KITS	
			FD MF	N°	DF	OE	UPGRADE 1	UPGRADE 2	FD MF	DF	OE		UPGRADE
continue BMW													
K 1200 LT	1200	09		FD272	2	DF707	W			FD251			
K 1200 RS ABS	1200	97	00	FD198	2	DF702	W			FD186	DF701	W	
K 1200 RS	1200	01		FD272	2	DF707	W			FD013	DF662	W	
K 1200 R	1200	05		FD272	2	DF707	W			FD186	DF763	W	
K 1200 R SPORT	1200	07		FD272	2	DF707	W			FD186	DF763	W	
K 1200 RT	1200	06		FD271	2	DF707	W			FD186	DF701	W	
K 1200 S	1200	04		FD271	2	DF707	W			FD186	DF763	W	
K 1200 ST	1200	06	08	FD271	2	DF707	W			FD186			
K 1200 ST	1200	09		FD271	2	DF707	W			FD186			
R 1200 CRUISER	1200	97		FD198	2	DF702	W			FD186	DF701	W	
R 1200 C AVANTGARDE	1200	00		FD198	2	DF702	W			FD186	DF701	W	
R 1200 C INDEPENDENT	1200	01		FD198	2	DF702	W			FD186	DF701	W	
R 1200 C MONTAUK	1200	04		FD272	2	DF702	W			FD186			
R 1200 GS	1200	04	08	FD271	2	DF702	W			FD186	DF763	W	KG702
R 1200 GS	1200	09		FD271	2	DF702	W			FD186	DF763	W	KG702
R 1200 GS LC	1200	13		FD475	2	DF702	W			FD172	DF720	W	KG702
R 1200 GS ADVENTURE	1200	06	08	FD271	2	DF702	W			FD186	DF763	W	KG702
R 1200 GS ADVENTURE	1200	09		FD271	2	DF702	W			FD186	DF763	W	KG702
R 1200 GS LC ADVENTURE	1200	13		FD475	2	DF702	W			FD172	DF720	W	KG702
R 1200 R	1200	06	08	FD272	2	DF707	W			FD186	DF763	W	
R 1200 R	1200	09	14	FD272	2	DF707	W			FD186	DF763	W	
R 1200 R	1200	15		FD475	2	DF707	W			FD172	DF720	W	
R 1200 R NINE T	1200	14		FD475	2	DF707	W			FD186	DF763	W	
R 1200 R NINE T PURE	1200	17		FD176	2	DF707	W			FD186	DF763	W	
R 1200 R NINE T RACER	1200	17		FD176	2	DF707	W			FD186	DF763	W	
R 1200 R NINE T SCRAMBLER	1200	16		FD176	2	DF707	W			FD186	DF763	W	
R 1200 R NINE T URBAN G/S	1200	18		FD176	2	DF707	W			FD186	DF763	W	
R 1200 RT	1200	05		FD271	2	DF707	W			FD186	DF763	W	
R 1200 RT SE	1200	10		FD271	2	DF707	W			FD186	DF763	W	
R 1200 RT LC	1200	14		FD475	2	DF707	W			FD172	DF720	W	
R 1200 RS	1200	15		FD475	2	DF707	W			FD172	DF720	W	
R 1200 S	1200	06	08	FD271	2	DF707	W			FD186	DF763	W	
R 1200 S	1200	09		FD271	2	DF707	W			FD186	DF763	W	
R 1200 ST	1200	05	08	FD271	2	DF707	W			FD186	DF763	W	
R 1200 ST	1200	09		FD271	2	DF707	W			FD186	DF763	W	
R 1250 GS	1250	19		FD537	2	DF702	W			FD172	DF720	W	
R 1250 GS ADVENTURE	1250	19		FD537	2	DF702	W			FD172	DF720	W	
R 1250 R	1250	19		FD475	2	DF707	W			FD172	DF720	W	
R 1250 RS	1250	19		FD475	2	DF707	W			FD172	DF720	W	
R 1250 RT	1250	19		FD537	2	DF707	W			FD172	DF720	W	
R 1250 RT SPORT	1250	19		FD537	2	DF707	W			FD172	DF720	W	
K 1300 GT	1300	09		FD271	2	DF707	W			FD186	DF763	W	
K 1300 R	1300	09		FD272	2	DF707	W			FD186	DF763	W	
K 1300 S	1300	09		FD271	2	DF707	W			FD186	DF763	W	
K 1300 S MOTOR SPORT	1300	15		FD475	2	DF707	W			FD186	DF763	W	
K 1600 B	1600	17		FD272	2	DF707	W			FD172	DF726	W	
K 1600 GRAND AMERICA	1600	18		FD272	2	DF707	W			FD172	DF726	W	
K 1600 GT	1600	11		FD272	2	DF707	W			FD172	DF726	W	
K 1600 GT SE	1600	12		FD272	2	DF707	W			FD172	DF726	W	
K 1600 GTL	1600	11		FD272	2	DF707	W			FD172	DF726	W	
K 1600 GTL E	1600	12		FD272	2	DF707	W			FD172	DF726	W	
R 18	1800	20		FD373	2					FD262			
BOMBARDIER 4 Wheels													
RALLY 200	200	03	04	FD094	2					FD			
RALLY 200	200	05		FD094	2					FD315			
OUTLANDER 330 DER.	330	04		FD315	2								
OUTLANDER 330 IZQ.	330	04		FD318	2					FD315			
OUTLANDER 400 DER.	400	03		FD315	2								
OUTLANDER 400 DER. MAX	400	03		FD315	2								
OUTLANDER 400 IZQ.	400	03		FD318	2					FD315			
OUTLANDER 400 IZQ. MAX	400	03		FD318	2					FD315			
TRAXTER 500 XL / XT	500	00		FD220	2	DF719	W			FD220	DF727	W	
DS 650 / BAJA DER.	650	00		FD318	2	DF719	W				DF727	W	
DS 650 / BAJA IZQ.	650	00		FD315	2	DF719	W			FD315	DF727	W	
QUEST 500/600 DER.	650	02		FD318	2	DF719	W				DF727	W	
QUEST 500/600 IZQ.	650	02		FD315	2	DF719	W			FD315	DF727	W	
TRAXTER MAX 650 DER.	650	04		FD318	2	DF719	W						
TRAXTER MAX 650 IZQ.	650	04		FD315	2	DF719	W			FD318			
OUTLANDER 800 DER.	800	06		FD318	2						DF727	W	
OUTLANDER 800 IZQ.	800	06		FD315	2					FD315	DF727	W	
BORILE													
B 500 CR	500	02		FD068	1					FD165			



APPLICATIONS
 PADS FD
 DISCS DF
 SHOES MF
 LINES FK
 BRACKETS SP
 KITS KG
 CROSS REFERENCE



APPLICATIONS

PADS FD

DISCS DF

SHOES MF

LINES FK

BRACKETS SP

KITS KG

CROSS REFERENCE

BRAND & MODEL * MARCA Y MODELO MARCA E MODELLO * MARQUE ET MODÈLE	C.C.	YEAR	FRONT					REAR				KITS
			FD _{MF}	N°	DF	OE	UPGRADE 1	UPGRADE 2	FD _{MF}	DF	OE	UPGRADE
continue BORILE												
B 500 MT	500	02	FD068	1						FD165		
BRATEC												
SERIE 210	DEL		FD065									
SERIE 213FR	TRAS									FD065		
SERIE 213RR	TRAS									FD065		
SERIE 215	TRAS									FD260		
SERIE 222	DEL		FD223									
SERIE 223	TRAS									FD224		
SERIE 235	DEL		FD162									
SERIE 242	TRAS									FD456		
SERIE 245	DEL		FD220									
SERIE 254	DEL		FD341									
SERIE 280	DEL		FD138									
SERIE 282	DEL		FD223									
SERIE 284	TRAS									FD456		
SERIE 365	DEL		FD460									
TRIAL RACING EVO17	DEL		FD511									
OFF ROAD 2P	DEL		FD138									
OFF ROAD 1P	TRAS									FD291		
BRAMMO												
EMPULSE	EL	19	FD176	2						FD220		
EMPULSE R	EL	19	FD176	2						FD220		
ENERTIA	EL	19	FD172	1						FD220		
ENERTIA PLUS	EL	19	FD172	1						FD220		
BREMO CUSTOM												
120B814**	DEL		FD262									
BREMO OFF ROAD												
122A99021	DEL		FD138									
XQ21361	DEL		FD138									
XQ21390	TRAS									FD291		
BREMO RACING												
120B765**	DEL		FD068									
129B766**	DEL		FD068									
2209885**	DEL		FD373									
220A016**	DEL		FD176									
220A168**	DEL		FD176									
220A397**	DEL		FD373									
220B010**	DEL		FD373									
X10117**	DEL		FD208									
X9737**	DEL		FD208									
X99C4** 4P	DEL		FD391									
XA3B8**	DEL		FD168									
XA7G2**	DEL		FD208									
XA888** (MOTO3)	DEL		FD391									
XA933**	DEL		FD208									
XA3.J7.F0/F1	DEL		FD478									
120A44110	TRAS									FD220		
120B27810	TRAS									FD220		
X206001	TRAS									FD181		
X206101	TRAS									FD		
X206121	TRAS									FD		
X988870	TRAS									FD		
XA1J040	TRAS									FD		
BRIXTON												
BX 125	125	19	FD086	1						FD117		
FELSBERG 125 X	125	19	FD086	1						FD117		
GLANVILLE 250 X	250	19	FD086	1						FD117		
SAXBY 250	250	19	FD086	1						FD117		
BUELL												
BLAST	500	00	FD140	1						FD103		
XB 9 R FIREBOLT F	984	02	07	FD402	1	DF820	W			FD103		
XB 9 S LIGHTNING F	984	03	04	FD402	1	DF820	W			FD103		
XB 9 SX CITYX	984	06	09	FD402	1	DF820	W			FD103		
1125 CR	1125	09		FD	1					FD398		
1125 R	1125	08		FD	1					FD398		
M2 CYCLONE	1200	00		FD384	1	DF882	CW			FD103	DF884	W
S3 THUNDERBOLT	1200	00		FD384	1	DF882	CW			FD103	DF884	W
SPECIAL M2 CYCLONE	1200	00		FD226	1	DF882	CW			FD103	DF884	W
X1 LIGHTNING	1200	00		FD384	1	DF882	CW			FD103	DF884	W
XB 12 R FIREBOLT	1200	06	08	FD402	1	DF820	W			FD103	DF884	W
XB 12 R FIREBOLT	1200	09		FD	1	DF820	W			FD103	DF884	W
XB 12 S LIGHTNING	1200	06	08	FD402	1	DF820	W			FD103	DF884	W



BRAND & MODEL · MARCA Y MODELO MARCA E MODELLO · MARQUE ET MODÉLE	C.C.	YEAR	FRONT						REAR				KITS KG	
			FD _{MF}	N°	DF	OE	UPGRADE 1	UPGRADE 2	FD _{MF}	DF	OE	UPGRADE		
continue BUELL														
XB 12 SS LIGHTNING LONG	1200	06	08	FD402	1	DF820	W				FD103	DF884	W	
XB 12 SS LIGHTNING LONG	1200	09		FD	1	DF820	W				FD103	DF884	W	
XB 12 X ULYSSES	1200	06	08	FD402	1	DF820	W				FD103	DF884	W	
XB 12 XT ULYSSES	1200	09	10	FD402	1	DF820	W				FD103	DF884	W	
BULTACO														
ASTRO	50	00		FD133	1	DF674	W	FLW			FD065	DF698	W	
LOBITO	50	99		FD133	1	DF674	W	FLW			FD065	DF698	W	
SHERCO 125	125	00		FD065	1						FD065			
SHERCO 200	200	00		FD065	1						FD065			
SHERCO 2.5	250	99		FD065	1						FD065			
SHERCO 290	290	00		FD065	1						FD065			
CAGIVA														
CITY 50	50	93		FD149	1	DF018					MF630	-		
CUCCIOLO	50	01		FD171	1						MF	-		
K3 50	50	92		FD012	1						FD048			
NAG 50	50	08		FD175	1						MF	-		
NUVOLA	50	00		FD171	1						MF	-		
PASSING 50	50	95		FD188	1	DF018								
PRIMA 50	50	92		FD151	1						FD152			
STRADA PRIMA 50	50	92		FD118	1						FD048			
SUPER CITY 50	50	92		FD151	1						FD152			
W4-50 PRO ACTION	50	92		FD012	1						FD048			
PRIMA 75	75	92		FD151	1						FD152			
SUPER CITY 80	80	92		FD151	1						FD152			
BLUS 125	125	93		FD074	1						FD048			
CUCCIOLO	125	99		FD171	1						MF	-		
K7 125 N90	125	91		FD089	1						FD075			
MITO 125 EDDY	125	93		FD068	1	DF660	CW	CRW			FD012			
MITO 125 SP 525	125	08		FD068	1	DF660	CW	CRW			FD012			
NUVOLA	125	00		FD171	1						MF	-		
PASSING 125	125	95		FD188	1	DF018					MF	-		
PLANET 125	125	98		FD068	1	DF660	CW	CRW			FD012			
RAPTOR 125	125	03		FD068	1	DF660	CW	CRW			FD012			
ROADSTER 125	125	93		FD074	1						MF	-		
SUPER CITY 125	125	91		FD119	1	DF660	CW	CRW			FD012			
W8 125	125	92		FD089	1						FD012			
W8 PRO ACTION	125	91		FD089	1						FD048			
WMX 125	125	90		FD089	1						FD075			
W12 350	350	93		FD089	1						FD135			
CANYON	500	99		FD082	1	DF006	W				FD117			
MITO 500	500	07	07	FD068	1	DF660	CW	CRW			FD012			
MITO 500	500	08		FD262	1	DF660	CW	CRW			FD012			
RIVER 500	500	00		FD068	1	DF660	CW	CRW			FD171			
CANYON	600	95		FD129	1	DF006	W				FD117			
RIVER 600	600	95		FD068	1	DF660	CW	CRW			FD012			
W 16 600	600	95		FD089	1						FD075			
V-RAPTOR	650	01		FD176	2	DF472	FLW	FLV			FD220			
ELEFANT 750	750	94		FD138	1	DF009	W				FD138	DF007	W	
CANYON	900	97		FD172	2	DF009	W				FD117	DF458	W	
ELEFANT 900	900	94		FD138	2						FD138	DF007	W	
ELEFANT 900 CATALITICA	900	93	93	FD138	2						FD140	DF007	W	
ELEFANT 900 i.e.	900	91	92	FD082	1	DF009	W				FD145	DF007	W	
GRAN CANYON	900	99		FD266	2	DF009	W				FD117	DF007	W	
NAVIGATOR	1000	00		FD266	2	DF009	W				FD117			
RAPTOR	1000	00		FD176	2	DF472	FLW	FLV			FD220			
V-RAPTOR	1000	00		FD176	2	DF472	FLW	FLV			FD220			
X-TRA RAPTOR	1000	02		FD176	2	DF472	FLW	FLV			FD220			
CAN-AM														
RYKER 600 IZQ./LEFT	600	18		FD514	1						FD514			
RYKER 600 DER./RIGHT	600	18		FD515	1									
RYKER 900 IZQ./LEFT	900	18		FD514	1						FD514			
RYKER 900 DER./RIGHT	900	18		FD515	1									
RYKER 900 RALLY EDITION IZQ./LEFT	900	18		FD514	1						FD514			
RYKER 900 RALLY EDITION DER./RIGHT	900	18		FD515	1									
CAN-AM 4 Wheels														
DS 90 X	90	08		FD094	2						FD094			
RALLY 200	200	07		FD073	2						FD315			
DS 250	250	07		FD336	2						FD336			
OUTLANDER 400 STD/XT IZQ./LEFT	400	07		FD315	2									
OUTLANDER 400 STD/XT DER./RIGHT	400	07		FD318	2						FD315			
OUTLANDER 400 MAX STD/XT IZQ./LEFT	400	07		FD315	2									
OUTLANDER 400 MAX STD/XT DER./RIGHT	400	07		FD318	2						FD315			



APPLICATIONS
 PADS FD
 DISCS DF
 SHOES MF
 LINES FK
 BRACKETS SP
 KITS KG
 CROSS REFERENCE



APPLICATIONS

PADS FD

DISCS DF

SHOES MF

LINES FK

BRACKETS SP

KITS KG

CROSS REFERENCE

BRAND & MODEL • MARCA Y MODELO MARCA E MODELLO • MARQUE ET MODÈLE	C.C.	YEAR	FRONT					REAR					KITS KG
			FD _{MF}	N°	DF	OE	UPGRADE 1	UPGRADE 2	FD _{MF}	DF	OE	UPGRADE	
continue CAN-AM 4 Wheels													
DS 450 X	450	08	FD	2						FD			
OUTLANDER 500 STD/XT IZQ./LEFT	500	07	FD315	2									
OUTLANDER 500 STD/XT DER./RIGHT	500	07	FD318	2						FD315			
OUTLANDER 500 MAX STD/XT IZQ./LEFT	500	07	FD315	2									
OUTLANDER 500 MAX STD/XT DER./RIGHT	500	07	FD318	2						FD315			
DS 650 X IZQ./LEFT	650	07	FD315	2									
DS 650 X DER./RIGHT	650	07	FD318	2						FD315			
OUTLANDER 650 STD/XT IZQ./LEFT	650	07	FD315	2									
OUTLANDER 650 STD/XT DER./RIGHT	650	07	FD318	2						FD315			
OUTLANDER 650 MAX STD/XT IZQ./LEFT	650	07	FD315	2									
OUTLANDER 650 MAX STD/XT DER./RIGHT	650	07	FD318	2						FD315			
OUTLANDER 800 STD/XT IZQ./LEFT	800	07	FD315	2									
OUTLANDER 800 STD/XT DER./RIGHT	800	07	FD318	2						FD315			
OUTLANDER 800 MAX STD/XT IZQ./LEFT	800	07	FD315	2									
OUTLANDER 800 MAX STD/XT DER./RIGHT	800	07	FD318	2						FD315			
RENEGADE 800 HO efi IZQ./LEFT	800	07	FD315	2									
RENEGADE 800 HO efi DER./RIGHT	800	07	FD318	2						FD315			
CAN-AM SIDE x SIDE													
DEFENDER IZQ./LEFT	800	16	FD514	1	DF980	W				FD	DF980	W	
DEFENDER DER./RIGHT	800	16	FD515	1	DF980	W				FD	DF980	W	
DEFENDER DPS IZQ./LEFT	800	16	FD514	1	DF980	W				FD	DF980	W	
DEFENDER DPS DER./RIGHT	800	16	FD515	1	DF980	W				FD	DF980	W	
DEFENDER XT IZQ./LEFT	800	16	FD514	1	DF980	W				FD	DF980	W	
DEFENDER XT DER./RIGHT	800	16	FD515	1	DF980	W				FD	DF980	W	
DEFENDER XT CAB IZQ./LEFT	800	16	FD514	1	DF980	W				FD	DF980	W	
DEFENDER XT CAB DER./RIGHT	800	16	FD515	1	DF980	W				FD	DF980	W	
MAVERICK X3 MAX TURBO IZQ./LEFT	900	17	FD514	1	DF980	W				FD514	DF981	W	
MAVERICK X3 MAX TURBO DER./RIGHT	900	17	FD515	1	DF980	W				FD515	DF981	W	
MAVERICK X3 TURBO IZQ./LEFT	900	18	FD514	1	DF980	W				FD514	DF981	W	
MAVERICK X3 TURBO DER./RIGHT	900	18	FD515	1	DF980	W				FD515	DF981	W	
MAVERICK X3 TURBO R IZQ./LEFT	900	18	FD514	1	DF980	W				FD514	DF981	W	
MAVERICK X3 TURBO R DER./RIGHT	900	18	FD515	1	DF980	W				FD515	DF981	W	
MAVERICK X3 MAX TURBO R IZQ./LEFT	900	18	FD514	1	DF980	W				FD514	DF981	W	
MAVERICK X3 MAX TURBO R DER./RIGHT	900	18	FD515	1	DF980	W				FD515	DF981	W	
DEFENDER IZQ./LEFT	975	16	FD514	1	DF980	W				FD	DF980	W	
DEFENDER DER./RIGHT	975	16	FD515	1	DF980	W				FD	DF980	W	
DEFENDER DPS IZQ./LEFT	975	16	FD514	1	DF980	W				FD	DF980	W	
DEFENDER DPS DER./RIGHT	975	16	FD515	1	DF980	W				FD	DF980	W	
DEFENDER XT IZQ./LEFT	975	16	FD514	1	DF980	W				FD	DF980	W	
DEFENDER XT DER./RIGHT	975	16	FD515	1	DF980	W				FD	DF980	W	
DEFENDER XT CAB IZQ./LEFT	975	16	FD514	1	DF980	W				FD	DF980	W	
DEFENDER XT CAB DER./RIGHT	975	16	FD515	1	DF980	W				FD	DF980	W	
MAVERICK X3 IZQ./LEFT	1000	17	FD514	1	DF970	W				FD514	DF971	W	
MAVERICK X3 DER./RIGHT	1000	17	FD515	1	DF970	W				FD515	DF971	W	
CANNONDALE													
XC 400	400	01	FD164	1	DF338	W				FD114	DF718	W	
E 440	440	01	FD164	1	DF338	W				FD114	DF718	W	
X 440	440	01	FD164	1	DF338	W				FD114	DF718	W	
X 440 S	440	01	FD164	1	DF338	W				FD114	DF718	W	
CANNONDALE 4 Wheels													
FX 400 DER.	400	01	FD318	2	DF717	W							
FX 400 IZQ.	400	01	FD315	2	DF717	W				FD315	DF716	W	
CANNIBAL 440 DER.	440	02	FD318	2	DF717	W							
CANNIBAL 440 IZQ.	440	02	FD315	2	DF717	W				FD315	DF716	W	
BLAZE 440 DER.	440	02	FD318	2	DF717	W							
BLAZE 440 IZQ.	440	02	FD315	2	DF717	W				FD315	DF716	W	
GLAMIS 440 DER.	440	03	FD318	2	DF717	W							
GLAMIS 440 IZQ.	440	03	FD315	2	DF717	W				FD315	DF716	W	
MOTO 440 DER.	440	02	FD318	2	DF717	W							
MOTO 440 IZQ.	440	02	FD315	2	DF717	W				FD315	DF716	W	
SPEED 440 DER.	440	02	FD318	2	DF717	W							
SPEED 440 IZQ.	440	02	FD315	2	DF717	W				FD315	DF716	W	
CCM													
C-XR 125 E	125	08	FD073	1						FD095			
C-XR 125 M	125	08	FD073	1						FD095			
C-XR 125 S	125	08	FD073	1						FD095			
RL 125	125	08	FD187	1						MF	-		
SM 125	125	08	FD187	1						FD145			
TL 125	125	08	FD073	1						FD145			
C-XR 230 E	230	07	FD073	1						FD095			
C-XR 230 M	230	07	FD073	1						FD095			
C-XR 230 S	230	07	FD073	1						FD095			



BRAND & MODEL · MARCA Y MODELO MARCA E MODELLO · MARQUE ET MODÉLE	C.C.	YEAR	FRONT					REAR				KITS KG	
			FD _{MF}	N°	DF	OE	UPGRADE 1	UPGRADE 2	FD _{MF}	DF	OE		UPGRADE
continue CCM													
XTR 250	250	09	FD073	1						FD079			
404 E	404	03	FD138	1	DF677	W	FLW	FLS		FD165	DF678	WLL	WS
404 DS	404	03	FD138	1	DF677	W	FLW	FLS		FD165	DF678	WLL	WS
404 DS SUPER MOTARD	404	03	FD138	1	DF677	W	FLW	FLS		FD165	DF678	WLL	WS
450 ADVENTURE	450	15	FD172	1						FD165	DF607	WS	
450 ADVENTURE SM	450	16	FD172	1						FD165	DF607	WS	
604 E DS	604	98 03	FD138	1	DF677	W	FLW	FLS		FD165	DF678	WLL	WS
604 E SUPER MOTARD	604	98 03	FD138	1	DF677	W	FLW	FLS		FD165	DF678	WLL	WS
604 RS ROADSTER	604	00 03	FD138	1	DF677	W	FLW	FLS		FD165	DF678	WLL	WS
644 DS	644	04	FD138	1	DF677	W	FLW	FLS		FD165	DF678	WLL	WS
644 DS SUPER MOTARD	644	04	FD138	1	DF677	W	FLW	FLS		FD165	DF678	WLL	WS
R 30	644	02	FD138	1	DF677	W	FLW	FLS		FD165	DF678	WLL	WS
FT 710	710	08	FD138	1						FD165			
CCM 4 Wheels													
LX 350 4 A	350	08	FD095	2						FD075			
LX 700 4 A	700	08	FD095	2						FD			
CFMOTO													
E-CHARM	125	10	FD187	1						FD079			
GLORY	125	10	FD187	1						FD200			
E-CHARM	150	10	FD187	1						FD079			
GLORY	150	10	FD187	1						FD200			
JET MAX DER/RIGHT	250	10	FD145	2									
JET MAX IZQ/LEFT	250	10	FD187	2						FD200			
NK 250	250	19	FD	1						FD165			
NK 300	300	20	FD	1						FD165			
NK 650	650	13	FD266	2						FD167			
NK 650 MT ADVENTURE TOURER	650	20	FD266	2						FD165			
TK 650 DER/RIGHT	650	16	FD179	2									
TK 650 IZQ/LEFT	650	16	FD174	2						FD167			
NK 700	700	20	FD176	1						FD138			
NK 700 ADVENTURE	700	20	FD176	1						FD138			
NK 700 CLX	700	20	FD176	1						FD138			
NK 700 HERITAGE	700	20	FD176	1						FD138			
NK 700 SPORT	700	20	FD176	1						FD138			
CH RACING													
WSM 50 MOTARD	50	05	FD133	1						FD065			
WXE 50 ENDURO	50	05	FD133	1						FD065			
WSM 125 MOTARD	125	05	FD133	1						FD065			
WXE 125 ENDURO	125	05	FD133	1						FD065			
CLIPIC													
CJ 50 E	50	99	FD065	1						FD065			
CJ 50 R	50	99	FD065	1						FD065			
CJ RACING	50	99	FD065	1						FD065			
CJ 80 R	80	99	FD065	1						FD065			
MINJ 125	125	06	FD065	1						FD065			
MINJ 200	200	06	FD065	1						FD065			
CONTI													
PROMO CUP	50	00 03	FD048	1	DF674	W	FLW			FD153			
PROMO CUP	50	04	FD210	1	DF811	W				FD153			
RX 356 V3	80	05	FD341	1						FD065			
CPI													
ARAGON /GP 50	50	06	FD175	1						MF458	-		
FREAKY	50	07	FD175	1						MF458	-		
GTR	50	03	FD162	1						FD153			
GTS	50	03	FD162	1						FD153			
HUSSAR	50	01	FD094	1	DF037	W	RW	FLS		MF458	-		
POPCORN	50	01	FD175	1	DF037	W	RW	FLS		MF458	-		
SM POWER	50	06	FD065	1						FD065			
SUPERCROSS 50	50	06	FD065	1						FD065			
SUPERCROSS 50 ULTIMATE	50	06	FD065	1						FD065			
SX POWER	50	06	FD065	1						FD065			
ARAGON /GP 125	125	07	FD175	1						MF452	-		
GTR 125	125	03	FD162	1						FD153			
GTS 125	125	03	FD162	1						FD153			
SUPERMOTO 125	125	07	FD065	1						FD065			
X-LARGE 125	125	03	FD220	1						FD220			
GTR 150	150	03	FD162	1						FD153			
GTS 150	150	03	FD162	1						FD153			
X-LARGE 150	150	03	FD220	1						FD220			
GTR 200	200	03	FD162	1						FD153			
GTS 200	200	03	FD162	1						FD153			
X-LARGE 250	250	03	FD220	1						FD220			





APPLICATIONS

PADS FD

DISCS DF

SHOES MF

LINES FK

BRACKETS SP

KITS KG

CROSS REFERENCE

BRAND & MODEL · MARCA Y MODELO MARCA E MODELLO · MARQUE ET MODÈLE	C.C.	YEAR	FRONT					REAR				KITS	
			FD _{MF}	N°	DF	OE	UPGRADE 1	UPGRADE 2	FD _{MF}	DF	OE	UPGRADE	KG
CPI 4 Wheels													
QUAD 50	50	03	MF		-					FD094			
XT 50 QUAD	50	06	MF		-					FD117			
QUAD 100	100	03	MF		-					FD094			
XS 250 QUAD	250	06	FD336	2						FD117			
CSR													
MAX	125	09	FD145	1						FD145			
ONA	125	04	FD175	1						FD175			
SCOO	125	04	FD175	1						FD175			
ONA	150	06	FD175	1						FD175			
SCOO	150	06	FD175	1						FD175			
CUSTOM 250 AUTOMATICA	250	06	FD124	1						FD127			
CRUISER 250 AUTOMATICA	250	06	FD124	1						FD127			
DAELIM													
A-FOUR	50	06	FD187	1						MF	-		
BONITA 50	50	09	FD149	1						MF	-		
CORDI	50	04	FD149	1						MF	-		
E-FIVE	50	03	FD149	1						MF	-		
MESSAGE 50	50	98	FD149	1						MF	-		
S-FIVE 50	50	01	FD149	1						MF	-		
DELFINO	100	03	FD095	1						MF	-		
CITI ACE 110	110	06	FD145	1						MF	-		
AVANCE II	125	98	FD095	1						MF	-		
B-BONE	125	08	FD222	1						FD095			
BESBI	125	08	FD144	1						MF	-		
DAYSTAR 125	125	00	FD140	1						MF	-		
DAYSTAR VL 125Z F1 PLUS	125	14	FD140	1	DF031	W				FD145			
DELFINO 125	125	08	FD117	1						MF	-		
HISTORY	125	02	FD095	1						FD095			
NS 125	125	98 99	FD095	1						MF	-		
NS 125 II	125	00 00	FD095	1						MF	-		
NS 125 III	125	01 01	FD095	1						MF	-		
NS 125 DXL	125	02	FD095	1						FD095			
OTELLO f.i.	125	08	FD222	1						FD095			
ROADWIN	125	03 10	FD140	1						FD145			
ROADWIN 125 R f.i.	125	11	FD140	1						FD145			
S2 125 FREEWING	125	06 07	FD140	1						FD095			
S2 125 FREEWING f.i.	125	08	FD222	1						FD095			
S3 125 Fi	125	10 11	FD275	1						FD145			
S3 125 Fi	125	12 14	FD275	1						FD399			
VL DAYSTAR 125	125	02	FD140	1						MF	-		
VS 125	125	98	FD095	1						MF	-		
VT/VS CUSTOM	125	98	FD140	1						MF	-		
ROADWIN 250	250	08 10	FD140	2						FD117			
ROADWIN 250 R FI	250	11	FD140	2						FD117			
S2 250 FREEWAY	250	06	FD140	1						FD117			
S3 250 Fi ADVANCE	250	12 14	FD275	1						FD399			
DAELIM 4 Wheels													
ET 250 QUAD	250	06	FD094	2						FD399			
ET 300 QUAD	300	07	FD094	2						FD399			
DERBI													
ATLANTIS	50	99	FD065	1						MF301	-		
AVENTURA	50	96	FD065	1						MF625	-		
BLACK DEVIL	50	04	FD162	1	DF674	W	FLW			FD065	DF698	W	
DRD 50 PRO R	50	06	FD220	1						FD065			
DRD 50 R RACING	50	06	FD162	1						FD065			
DRD 50 R RACING PRO	50	06	FD220	1						FD065			
DRD 50 SM EDITION / RACING	50	06	FD220	1						FD065			
FENIX	50	93	FD065	1						MF625	-		
FURAX 50	50	96	FD065	1						MF625	-		
GP 1	50	01 04	FD065	1						FD065	DF705	W	
GP 1	50	05	FD220	1						FD065	DF705	W	
GP 1 OPEN	50	06	FD162	1						FD065			
GPR 50 NUDE	50	04	FD220	1						FD065			
GPR 50 R	50	97 03	FD133	1						FD065			
GPR 50 R	50	04 09	FD220	1						FD065			
GPR 50 R	50	10	FD341	1						FD252			
GPR 50 SPORT	50	93 96	FD084	1						FD048			
GPX 1	50	06	FD220	1						FD065			
HUNTER 50	50	96	FD065	1						MF301	-		
PADDOCK 50	50	96	FD065	1						MF301	-		
PREDATOR	50	98 98	FD065	1						FD065			
PREDATOR O.2	50	99	FD065	1						MF301	-		



BRAND & MODEL · MARCA Y MODELO MARCA E MODELLO · MARQUE ET MODÈLE	C.C.	YEAR	FRONT					REAR				KITS KG	
			FD _{M.F.}	N°	DF	OE	UPGRADE 1	UPGRADE 2	FD _{M.F.}	DF	OE		UPGRADE
continue DERBI													
PROGRESS 50	50	97	FD065	1					MF301	-			
RAMBLA 50	50	06	FD270	1					FD270				
RECORD 50	50	98	FD065	1					MF301	-			
SABANA 50	50	90	FD065	1					FD065				
SEND A	50	93 95	FD065	1					MF625	-			
SEND A	50	97	FD065	1					FD065	DF700	W		
SEND A PRO	50	08	FD220	1					FD270				
SEND A R DRD	50	02 04	FD162	1	DF674	W	FLW		FD065	DF700	W		
SEND A SM DRD	50	02 04	FD065	2	DF708	W			FD065	DF698	W		
SEND A SM DRD 50 EVO	50	09	FD220	1	DF759	W			FD065	DF698	W		
SEND A SM DRD LIMITED	50	05	FD065	2	DF708	W			FD065	DF709	W		
SEND A X-TREM R	50	03	FD065	1					FD065	DF700	W		
SONAR	50	10	FD200	1					MF	-			
SUPERMOTARD	50	98	FD065	1					FD065				
URBAN, BOX	50	94	MF625		-				MF625	-			
VAMOS	50	94 94	FD065	1					MF625	-			
VAMOS R	50	95 95	FD170	1					MF625	-			
VAMOS R	50	96	FD065	1					MF625	-			
VARIANT SPORT R	50	94	FD065	1					MF625	-			
WAVE	50	00	FD065	1					MF301	-			
X RACE 50	50	06	FD065	1					FD065	DF700	W		
GPR 75 SPORT	75	90	FD084	1					FD048				
GPR 80 R CUP	80	04	FD341	1					FD065				
ATLANTIS 100	100	01	FD065	1					MF301	-			
ATLANTIS 100 4T	100	01	FD065	1					MF301	-			
BOULERVARD	125	03 06	FD270	1	DF737	W			MF	-			
BOULERVARD S	125	07	FD074	1	DF671	W	FLW		FD228	DF612	W		
CROSS CITY	125	09	FD409	1	DF888	W			FD270	DF698	W		
FREEXTER 125	125	06	FD341	1					FD270				
GP 1 125	125	06	FD220	1					FD220				
GPR 125 4T 4V	125	09	FD341	1					FD252				
GPR 125 NUDE	125	04	FD341	1					FD065				
GPR 125 R	125	04 08	FD341	1					FD065				
GPR 125 R	125	09	FD341	1					FD252				
MULHACEN 125	125	06	FD409	1	DF888	W			FD252	DF698	W		
MULHACEN CAFÉ 125	125	08	FD341	1					FD252				
RAMBLA 125	125	07	FD074	1	DF671	W	FLW		FD228	DF612	W		
SEND A DRD 125 R 4T 4V	125	09	FD220	1	DF674	W	FLW		FD252	DF675	W		
SEND A DRD 125 R RACING	125	06	FD162	1					FD065				
SEND A DRD 125 SM 4T 4V	125	09	FD220	1					FD252	DF675	W		
SEND A R 4T	125	04	FD162	1	DF674	W	FLW		FD065	DF675	W		
SEND A SM 4T	125	04	FD162	1					FD065	DF675	W		
SONAR	125	10	FD200	1					MF	-			
TERRA 4T 125	125	06	FD409	1	DF888	W			FD252	DF698	W		
TERRA 4T 125 ADVENTURE	125	08	FD409	1					FD252	DF698	W		
BOULERVARD	150	03	FD270	1	DF737	W			MF	-			
BOULERVARD	200	05	FD270	1	DF737	W			MF	-			
GP 1 250	250	05 07	FD220	2					FD220	DF667	W		
GP 1 250 i	250	08	FD220	2					FD252				
RAMBLA 250 ie	250	08	FD074	2	DF671	W	FLW		FD228	DF612	W		
RAMBLA 300 ie	300	10	FD074	2	DF671	W	FLW		FD228	DF612	W		
MULHACEN 650	650	06	FD262	1					FD220				
DERBI 4 Wheels													
DXR 200	200	04	MF		-				FD187				
DXR 250	250	04	MF		-				FD187				
DORTON													
MAXI URBAN 125	125	06	FD095	1					MF	-			
DUCATI													
350 SPORT	350	91	FD068	1	DF660	CW	CRW		FD012	DF636	W		
400 MONSTER (JAPON)	400	04	FD176	2	DF660	CW	CRW		FD220	DF636	W		
400 SS	400	93	FD068	1	DF660	CW	CRW		FD012	DF636	W		
400 SS JUNIOR	400	91 92	FD044	1					FD012				
SIXTY 2	400	16	FD172	1					FD165	DF636	W		
502	502	92	FD068	1					FD012				
600 M MONSTER	600	94 00	FD068	1	DF660	CW	CRW		FD012	DF636	W		
600 SS	600	93	FD068	1	DF660	CW	CRW		FD012	DF636	W		
600 SUPERMONO DESMO QUATTRO	600	93	FD068	1					FD012				
620 SS	620	03	FD176	2	DF660	CW	CRW		FD220	DF636	W		
MONSTER 620 / DARK	620	05	FD138	2	DF870	CW			FD220	DF636	W		
MONSTER 620 S i.e	620	01 04	FD176	2	DF660	CW	CRW		FD012	DF636	W		
MULTISTRADA MTS 620	620	05	FD138	2	DF870	CW			FD012	DF636	W		
MULTISTRADA MTS 620 DARK	620	05	FD176	1	DF660	CW	CRW		FD012	DF636	W		





APPLICATIONS

PADS FD

DISCS DF

SHOES MF

LINES FK

BRACKETS SP

KITS KG

CROSS REFERENCE

BRAND & MODEL · MARCA Y MODELO MARCA E MODELLO · MARQUE ET MODÈLE	C.C.	YEAR	FRONT					REAR				KITS KG
			FD	N°	DF	OE	UPGRADE 1	UPGRADE 2	FD	DF	OE	
continue DUCATI												
MONSTER 695	695	06	FD138	2	DF870	CW			FD012	DF636	W	
MONSTER 696	695	08	FD176	2	DF660	CW	CRW		FD220	DF636	W	
748	748	98 99	FD176	2	DF660	CW	CRW		FD012	DF630	W	
748 DESMO QUATTRO	748	94 97	FD068	2	DF660	CW	CRW		FD012	DF630	W	
748 E/S	748	00 02	FD176	2	DF660	CW	CRW		FD012	DF630	W	
748 R	748	01 02	FD262	2	DF660	CW	CRW		FD220	DF630	W	
749	749	03	FD262	2	DF880	CW	CRW		FD220	DF706	W	
749 S/R	749	03	FD262	2	DF880	CW	CRW		FD220	DF706	W	
750 M MONSTER	750	96	FD068	1	DF660	CW	CRW		FD012	DF636	W	
750 SPORT	750	01	FD176	1	DF660	CW	CRW		FD220	DF636	W	
750 SS	750	91 97	FD068	1	DF660	CW	CRW		FD012	DF636	W	
750 SS	750	98	FD176	2	DF660	CW	CRW		FD220	DF636	W	
HYPERMOTARD	796	10	FD176	2	DF773	CW			FD220	DF769	W	
MONSTER 796	796	10	FD176	2	DF807	CW	CRW		FD220	DF769	W	
MONSTER 796 ABS	796	10	FD176	2	DF807	CW	CRW		FD220	DF913	W	
800 SPORT	800	03	FD176	2	DF660	CW	CRW		FD220	DF636	W	
800 SS	800	03	FD176	2	DF660	CW	CRW		FD220	DF636	W	
MONSTER 800 S i.e	800	03 04	FD176	2	DF660	CW	CRW		FD012	DF636	W	
MONSTER 800 S2R	800	05	FD138	2	DF870	CW			FD220	DF769	W	
SCRAMBLER CAFÉ RACER	800	17	FD475	1	DF912	CW			FD165	DF636	W	
SCRAMBLER CLASSIC	800	15	FD475	1	DF912	CW			FD165	DF636	W	
SCRAMBLER DESERT SLED	800	17	FD475	1	DF912	CW			FD165	DF636	W	
SCRAMBLER FLAT TRACK	800	16	FD475	1	DF912	CW			FD165	DF636	W	
SCRAMBLER FULL THROTTLE	800	15	FD475	1	DF912	CW			FD165	DF636	W	
SCRAMBLER HASHTAG	800	19	FD475	1	DF912	CW			FD165	DF636	W	
SCRAMBLER ICON	800	15	FD475	1	DF912	CW			FD165	DF636	W	
SCRAMBLER URBAN ENDURO	800	15	FD475	1	DF912	CW			FD165	DF636	W	
MONSTER 797	803	17	FD475	2	DF807	CW	CRW		FD165	DF636	W	
HYPERMOTARD	821	13	FD475	2	DF807	CW			FD220	DF913	W	
HYPERMOTARD SP	821	13	FD475	2	DF807	CW			FD220	DF913	W	
HYPERSTRADA	821	13	FD475	2	DF807	CW			FD220	DF913	W	
MONSTER 821	821	14	FD475	2	DF807	CW			FD220	DF636	W	
MONSTER 821 STEALTH	821	19	FD475	2	DF807	CW			FD220	DF636	W	
848	848	08	FD176	2	DF880	CW	CRW		FD220	DF769	W	
848 EVO	848	10	FD373	2	DF880	CW	CRW		FD220	DF769	W	
848 EVO CORSE SE	848	12	FD373	2	DF880	CW	CRW		FD220	DF769	W	
848 S	848	08	FD176	2	DF880	CW	CRW		FD220	DF769	W	
848 STREETFIGHTER	848	12	FD176	2	DF880	CW	CRW		FD220	DF769	W	
848 STREETFIGHTER EVO SP	848	12	FD373	2	DF880	CW	CRW		FD220	DF769	W	
851 SPORT PRODUCTION	851	90 91	FD068	2	DF660	CW	CRW		FD012	DF636	W	
888 CORSA	888	91 91	FD068	2					FD012			
888 DESMO QUATTRO	888	93 93	FD068	2					FD012	DF636	W	
888 SPS	888	92 92	FD068	2	DF660	CW	CRW		FD012	DF636	W	
888 STRADA	888	94 95	FD068	2	DF660	CW	CRW		FD012	DF636	W	
899 PANIGALE	899	13	FD475	2	DF880	CW	CRW		FD220	DF636	W	
900 M MONSTER	900	93 99	FD068	2	DF660	CW	CRW		FD012	DF636	W	
900 M MONSTER	900	00 02	FD176	2	DF660	CW	CRW		FD012	DF636	W	
900 SS	900	91 97	FD068	2	DF660	CW	CRW		FD012	DF636	W	
900 SS	900	98	FD176	2	DF660	CW	CRW		FD220	DF636	W	
900 SUPERLIGHT	900	93	FD068	2	DF660	CW	CRW		FD012	DF636	W	
MH 900 E	900	00	FD176	2	DF660	CW	CRW		FD012			
907 i.e.	907	90 91	FD068	2	DF472	CW	FLV		FD012	DF636	W	
907 i.e.	907	92	FD068	2	DF660	CW	CRW		FD012	DF636	W	
916 SENNA	916	94 97	FD068	2	DF660	CW	CRW		FD012	DF630	W	
916 SPS	916	98 98	FD068	2	DF660	CW	CRW		FD012	DF630	W	
916 STRADA	916	94 98	FD068	2	DF660	CW	CRW		FD012	DF630	W	
MONSTER S4	916	01 02	FD176	2	DF660	CW	CRW		FD012	DF636	W	
ST 4	916	99	FD176	2	DF660	CW	CRW		FD220	DF636	W	
HYPERMOTARD 939	937	16	FD475	2	DF773	CW	CRW		FD220	DF913	W	
HYPERMOTARD 950	937	19	FD475	2	DF773	CW	CRW		FD220	DF913	W	
HYPERMOTARD 950 S	937	19	FD475	2	DF773	CW	CRW		FD220	DF913	W	
HYPERMOTARD 950 SP	937	19	FD475	2	DF773	CW	CRW		FD220	DF913	W	
HYPERMOTARD SP 939	937	16	FD475	2	DF773	CW	CRW		FD220	DF913	W	
HYPERSTRADA 939	937	16	FD475	2	DF773	CW	CRW		FD220	DF913	W	
MULTISTRADA 950	937	17	FD475	2	DF807	CW	CRW		FD138	DF812	W	
MULTISTRADA 950 S	937	19	FD475	2	DF807	CW	CRW		FD138	DF812	W	
SUPERSPORT 939	937	17	FD475	2	DF807	CW			FD220	DF775	W	
SUPERSPORT 939 S	937	17	FD475	2	DF807	CW			FD220	DF775	W	
ST 2 944	944	97 98	FD068	2	DF660	CW	CRW		FD220	DF636	W	
959 PANIGALE	955	16	FD475	2	DF880	CW	CRW		FD220	DF636	W	
959 PANIGALE CORSE	955	18	FD475	2	DF880	CW	CRW		FD220	DF636	W	
DESMOSEDICI RR	989	07	FD373	2	DF880	CW	CRW		FD220	DF706	W	



BRAND & MODEL · MARCA Y MODELO MARCA E MODELLO · MARQUE ET MODÈLE	C.C.	YEAR	FRONT						REAR				KITS KG
			FD _{MF}	N°	DF	OE	UPGRADE 1	UPGRADE 2	FD _{MF}	DF	OE	UPGRADE	
continue DUCATI													
ST 3 / s ABS	992	06	FD176	2	DF660	CW	CRW		FD220	DF636	W		
996 R	996	99 01	FD262	2	DF660	CW	CRW		FD220	DF630	W		
996 S	996	99 01	FD176	2	DF660	CW	CRW		FD012	DF630	W		
MONSTER S4R	996	03 05	FD176	2	DF660	CW	CRW		FD220	DF769	W		
998	998	02	FD176	2	DF881	CW	FLW	CRW	FD012	DF630	W		
998 R	998	02	FD262	2	DF660	CW	CRW		FD012	DF630	W		
998 S	998	02	FD262	2	DF883	CW			FD012	DF630	W		
999 R	999	03	FD262	2	DF880	CW	CRW		FD220	DF706	W		
999 S	999	03	FD262	2	DF880	CW	CRW		FD220	DF706	W		
1000 MONSTER S i.e.	1000	03 05	FD176	2	DF660	CW	CRW		FD220	DF636	W		
1000 MONSTER S2R	1000	06	FD176	2	DF660	CW	CRW		FD220	DF769	W		
1000 MONSTER S4R	1000	03 05	FD176	2	DF660	CW	CRW		FD220	DF769	W		
1000 MONSTER S4Rs	1000	06	FD262	2	DF880	CW	CRW		FD220	DF769	W		
GT 1000	1000	05	FD172	2	DF660	CW	CRW		FD165	DF636	W		
MULTISTRADA 1000 DS	1000	03	FD176	2	DF768	W			FD220	DF769	W		
MULTISTRADA 1000 S DS	1000	06	FD262	2	DF768	W			FD220	DF769	W		
PAUL SMART 1000	1000	05	FD172	2	DF660	CW	CRW		FD165	DF636	W		
SPORT 1000	1000	05	FD172	2	DF660	CW	CRW		FD165	DF636	W		
SPORT 1000 S	1000	07	FD172	2	DF660	CW	CRW		FD165	DF636	W		
SS 1000 DS	1000	03	FD176	2	DF660	CW	CRW		FD220	DF636	W		
1098	1100	07 08	FD373	2	DF774	CW	CRW		FD220	DF775	W		
1098 S	1100	07 08	FD373	2	DF774	CW	CRW		FD220	DF775	W		
HYPERMOTARD	1100	07 09	FD176	2	DF773	CW			FD220	DF769	W		
HYPERMOTARD EVO	1100	10	FD176	2	DF773	CW			FD220	DF769	W		
HYPERMOTARD EVO SP	1100	10	FD373	2	DF773	CW			FD220	DF769	W		
HYPERMOTARD S	1100	07 09	FD373	2	DF773	CW			FD220	DF769	W		
MONSTER	1100	09	FD176	2	DF807	CW	CRW		FD220	DF913	W		
MONSTER EVO	1100	11	FD176	2	DF807	CW	CRW		FD220	DF913	W		
MONSTER S	1100	09	FD176	2	DF880	CW	CRW		FD220	DF913	W		
MONSTER S (OHLINS)	1100	09	FD176	2	DF880	CW	CRW		FD220	DF913	W		
MULTISTRADA 1100 DS	1100	07	FD176	2	DF768	W			FD220	DF769	W		
MULTISTRADA 1100 S DS	1100	07	FD176	2	DF768	W			FD220	DF769	W		
SCRAMBLER 1100	1100	18	FD475	2	DF807	CW			FD165	DF636	W		
SCRAMBLER 1100 SPECIAL	1100	18	FD475	2	DF807	CW			FD165	DF636	W		
SCRAMBLER 1100 SPORT	1100	18	FD475	2	DF807	CW			FD165	DF636	W		
SCRAMBLER 1100 SPORT PRO	1100	20	FD475	2	DF807	CW			FD165	DF636	W		
STREETFIGHTER	1100	09	FD373	2	DF774	CW	CRW		FD220	DF775	W		
STREETFIGHTER S	1100	09	FD373	2	DF774	CW	CRW		FD220	DF775	W		
PANIGALE V4	1103	18	FD373	2	DF774	CW	CRW		FD220	DF775	W		
PANIGALE V4 25 ANIVERSARIO 916	1103	20	FD373	2	DF774	CW	CRW		FD220	DF775	W		
PANIGALE V4 R	1103	19	FD373	2	DF774	CW	CRW		FD220	DF775	W		
PANIGALE V4 S	1103	18	FD373	2	DF774	CW	CRW		FD220	DF775	W		
PANIGALE V4 SPECIALE	1103	18	FD373	2	DF774	CW	CRW		FD220	DF775	W		
PANIGALE V4 SUPERLEGGERA	1103	20	FD373	2	DF774	CW	CRW		FD220	DF775	W		
STREETFIGHTER S V4	1103	20	FD373	2	DF774	CW	CRW		FD220	DF775	W		
STREETFIGHTER V4	1103	20	FD373	2	DF774	CW	CRW		FD220	DF775	W		
1198	1198	10	FD373	2	DF774	CW	CRW		FD220	DF775	W		
1198 R SP	1198	09	FD373	2	DF774	CW	CRW		FD220	DF775	W		
1198 S	1198	09	FD373	2	DF774	CW	CRW		FD220	DF775	W		
1199 PANIGALE	1199	12	FD373	2	DF774	CW	CRW		FD220	DF839	W		
1199 PANIGALE RS13	1199	13	FD373	2	DF774	CW	CRW		FD220	DF839	W		
1199 PANIGALE SUPERLEGGERA	1199	14	FD373	2	DF774	CW	CRW		FD220	DF839	W		
DIAVEL 1200	1200	11	FD373	2	DF807	CW	CRW		FD172	DF812	W		
DIAVEL STRADA 1200	1200	13	FD373	2	DF807	CW	CRW		FD172	DF812	W		
DIAVEL X 1200	1200	16	FD373	2	DF807	CW	CRW		FD172	DF812	W		
DIAVEL X S 1200	1200	16	FD373	2	DF807	CW	CRW		FD172	DF812	W		
MONSTER 1200	1200	14	FD475	2	DF807	CW	CRW		FD220	DF839	W		
MONSTER 1200 R	1200	16	FD373	2	DF825	CW	CRW		FD220	DF839	W		
MONSTER 1200 S	1200	14	FD373	2	DF825	CW	CRW		FD220	DF839	W		
MONSTER 1200 S BLACK	1200	20	FD373	2	DF825	CW	CRW		FD220	DF839	W		
MULTISTRADA 1200	1200	10 14	FD176	2	DF807	CW	CRW		FD220	DF839	W		
MULTISTRADA 1200	1200	15	FD475	2	DF807	CW	CRW		FD138	DF812	W		
MULTISTRADA 1200 ENDURO	1200	15	FD475	2	DF807	CW	CRW		FD138	DF812	W		
MULTISTRADA 1200 PIKES PEAK	1200	13 14	FD176	2	DF807	CW	CRW		FD220	DF839	W		
MULTISTRADA 1200 PIKES PEAK	1200	15	FD373	2	DF825	CW	CRW		FD138	DF812	W		
MULTISTRADA 1200 S	1200	15	FD373	2	DF825	CW	CRW		FD138	DF812	W		
MULTISTRADA 1200 S D air	1200	15	FD373	2	DF825	CW	CRW		FD138	DF812	W		
MULTISTRADA 1200 S GRAN TURISMO	1200	13 14	FD176	2	DF807	CW	CRW		FD220	DF839	W		
MULTISTRADA 1200 SS	1200	10 14	FD176	2	DF807	CW	CRW		FD220	DF839	W		
MULTISTRADA 1200 ST	1200	10 14	FD176	2	DF807	CW	CRW		FD220	DF839	W		
MULTISTRADA 1260 S GRAND TOUR	1260	20	FD373	2	DF825	CW	CRW		FD138	DF812	W		
MULTISTRADA 1260	1260	18	FD475	2	DF807	CW	CRW		FD138	DF812	W		



APPLICATIONS

PADS FD

DISCS DF

SHOES MF

LINES FK

BRACKETS SP

KITS KG

CROSS REFERENCE



APPLICATIONS

PADS FD

DISCS DF

SHOES MF

LINES FK

BRACKETS SP

KITS KG

CROSS REFERENCE

BRAND & MODEL * MARCA Y MODELO MARCA E MODELLO * MARQUE ET MODÈLE	C.C.	YEAR	FRONT					REAR				KITS KG
			FD _{MF}	N°	DF	OE	UPGRADE 1	UPGRADE 2	FD _{MF}	DF	OE	
continue DUCATI												
MULTISTRADA 1260 D air	1260	18	FD373	2	DF825	CW	CRW	FD138	DF812	W		
MULTISTRADA 1260 ENDURO	1260	19	FD475	2	DF825	CW	CRW	FD138	DF812	W		
MULTISTRADA 1260 PIKES PEAK	1260	18	FD373	2	DF825	CW	CRW	FD138	DF812	W		
MULTISTRADA 1260 S	1260	18	FD373	2	DF825	CW	CRW	FD138	DF812	W		
X DIAVEL 1260	1260	19	FD475	2	DF807	CW	CRW	FD172	DF812	W		
X DIAVEL 1260 S	1260	19	FD373	2	DF807	CW	CRW	FD172	DF812	W		
1299 PANIGALE	1299	15	FD373	2	DF774	CW	CRW	FD220	DF839	W		
1299 PANIGALE R	1299	15	FD373	2	DF774	CW	CRW	FD220	DF839	W		
1299 PANIGALE R FINAL EDITION	1299	17	FD373	2	DF774	CW	CRW	FD220	DF839	W		
1299 PANIGALE S	1299	15	FD373	2	DF774	CW	CRW	FD220	DF839	W		
1299 PANIGALE SUPERLEGGERA	1299	17	FD373	2	DF774	CW	CRW	FD220	DF839	W		
E-TON 4 Wheels												
VIPER 50 MINI / RLX 50 M	50	03	MF		-			FD094				
VIPER 70 / RLX 70	70	03	MF		-			FD094				
VIPER 90 / RLX 90	90	03	MF		-			FD094				
VIPER 90 R / RLX 90 R	90	03	MF		-			FD094				
CHALLENGE CLX 150	150	03	MF002		-			FD117				
VIPER 150 / RLX 150	150	05	MF002		-			FD117				
VIPER ST EXL 150	150	05	FD094	2				FD117				
YUKON ST ELX 150	150	03	MF002		-			FD117				
VECTOR ST 250 / 250	250	06	FD094	2				FD117				
VECTOR ST 300	300	07	FD094	2				FD399				
VORTEX ST 300	300	07	FD094	2				FD399				
ENERGICA												
EGO	EL	18	FD373	2				FD220				
EGO 45	EL	18	FD373	2				FD220				
EGO SPORT BLACK	EL	19	FD373	2				FD220				
EVA	EL	18	FD373	2				FD220				
EVA ESSE ESSE9	EL	18	FD373	2				FD220				
EVA RIVELLE	EL	20	FD373	2				FD220				
FACTORY												
PHANTHOM R 12	50	03	FD224	1				FD065				
PHANTHOM R 14	50	03	FD224	1				FD065				
YR 50	50	98	00	FD075	1			FD075				
YR 50 DESERT	50	01	FD162	1				FD065				
CHRONO SM 50	50	99	01	FD075	1			FD075				
CHRONO SM 50	50	02	FD162	1				FD065				
YR 125 CB	125	04	FD162	1				FD075				
YR 250	250	98	FD138	1				FD165				
FACTORY 4 Wheels												
MINI HELIX	50	02	MF		-			FD300				
HELIX 50	50	02	MF		-			FD075				
REX 50	50	02	MF		-			FD075				
TORNADO 50	50	02	MF		-			FD075				
HELIX 100	100	02	MF		-			FD075				
REX 100	100	02	MF		-			FD075				
TORNADO 100	100	02	MF		-			FD075				
TORNADO 150	150	02	MF		-			FD075				
FANTIC												
50 K-ROO	50	92	FD065	1	DF644			FD065				
50 TRIAL	50	92	FD065	1				FD065				
CABALLERO 50 RS, RC	50	92	93	FD012	1			FD048				
CABALLERO 50 RC	50	94	FD162	1				FD048				
CABALLERO 80 RC	50	94	FD074	1				FD048				
CICLONE	50	94	FD071	1				MF				
CLUBMAN 50	50	95	FD065	1				FD065				
GRINTA	50	97	FD136	1	DF466	W		FD135				
KET ROO	50	93	FD065	1				FD065				
LEADER 50	50	95	FD136	1				FD135				
REGOLARITA CASA	50	07	FD162	1				FD075				
REGOLARITA COMPETICION	50	07	FD164	1				FD093				
SUPERSEI MOTARD	50	07	FD162	1				FD075				
80 K-ROO	80	92	FD065	1				FD065				
80 TRIAL	80	92	FD065	1				FD065				
125 K-ROO	125	92	FD065	1				FD065				
125.7 TRIAL	125	90	FD065	1				FD065				
125.9 TRIAL	125	90	FD065	1				FD065				
CABALLERO	125	97	FD128	1				FD135				
CABALLERO FLAT TRACK	125	18	FD450	1				FD165				
CABALLERO MOTARD 4T	125	10	FD497	1				FD278				
CABALLERO RC 125	125	94	96	FD074	1			FD048				
CABALLERO SCRAMBLER	125	18	FD450	1				FD165				



BRAND & MODEL · MARCA Y MODELO MARCA E MODELLO · MARQUE ET MODÉLE	C.C.	YEAR	FRONT					REAR				KITS KG	
			FD _{M.F.}	N°	DF	OE	UPGRADE 1	UPGRADE 2	FD _{M.F.}	DF	OE		UPGRADE
continue FANTIC													
CABALLERO REGOLARITA 4T	125	10	FD497	1						FD278			
REGOLARITA CASA	125	07	FD162	1						FD075			
REGOLARITA COMPETICION	125	07	FD164	1						FD093			
SUPERSEI MOTARD	125	07	FD162	1						FD075			
X RIDER 125	125	07	FD164	1						FD093			
XX 125 2T	125	20	FD364	1	DF298	W				FD286	DF515	W	
CABALLERO MOTARD 4T	200	10	FD497	1						FD278			
CABALLERO REGOLARITA 4T	200	10	FD497	1						FD278			
247 TRIAL	247	90	FD065	1						FD065			
249 SECTION	250	95	FD065	1						FD065			
250 COACH	250	92	93	FD065	1					MF712	-		
250 COACH	250	95		FD065	1					FD065			
CABALLERO FLAT TRACK	250	18	FD450	1	DF954	FLW				FD165			
CABALLERO SCRAMBLER	250	18	FD450	1	DF954	FLW				FD165			
ENDURO 4T	250	16	17	FD497	1					FD278			
XE 250 2T	250	20	FD364	1	DF298	W				FD286	DF515	W	
309 TRIAL	309	91	FD065	1						FD065			
CABALLERO FLAT TRACK	500	18	FD450	1	DF954	FLW				FD165			
CABALLERO SCRAMBLER	500	18	FD450	1	DF954	FLW				FD165			
GARELLI													
50 BIG RACING	50	94	FD136	1						MF	-		
50 BIG WHEELS	50	94	FD136	1	DF466	W				FD071	DF466	W	
50 KOALA	50	94	FD048	1						FD048			
50 PONY, SR	50	94	FD136	1	DF466	W				FD071			
50 QUEENIE	50	95	FD094	1						MF	-		
50 SUPER CICLONE AC	50	91	FD071	1						MF722	-		
125 TRIAL SECTION	125	95	FD065	1						FD065			
249 TRIAL SECTION	249	95	FD065	1						FD065			
GAS GAS													
EC ENDUCROSS BOY	50	99	05	FD225	1					FD225			
EC ENDUCROSS BOY	50	06		FD225	1					FD224			
EC ROOKIE	50	01		FD133	1					FD225			
MC 50	50	06		FD225	1					FD224			
SM 50	50	05		FD162	1					FD225			
SM ROOKIE	50	01	04	FD133	1					FD225			
TXT BOY	50	99	02	FD225	1					FD225			
TXT ROOKIE	50	03		FD225	1					FD225			
MC 65	65	06		FD224	1					FD224			
EC ENDUCROSS BOY	70	99		FD225	1					FD225			
TXT BOY	70	99		FD225	1					FD225			
ENDUCROSS 80	80	94		FD138	1					FD074			
TXT CADET	80	06		FD224	1					FD224			
TXT PRO 80 RACING	80	15		FD225	1					FD224			
TXT ROOKIE	80	03	05	FD225	1					FD225			
TXT ROOKIE	80	06		FD225	1					FD224			
125 PAMPERA	125	96	98	FD065	1					FD065			
125 PAMPERA	125	03		FD162	1	DF674	W	FLW		FD225			
125 PAMPERA 4T	125	99	02	FD065	1					FD065			
EC 125	125	94	00	FD138	1	DF677	W	FLW	FLS	FD074	DF678	WLL	WS
EC 125	125	01	14	FD164	1	DF677	W	FLW	FLS	FD093	DF678	WLL	WS
EC 125	125	15		FD164	1	DF677	W	FLW	FLS	FD286	DF678	WLL	WS
EC 125 SIX DAYS	125	11		FD164	1	DF677	W	FLW	FLS	FD286	DF678	WLL	WS
ENDUCAMP 125 4T	125	05		FD162	1	DF677	W	FLW	FLS	FD093	DF678	WLL	WS
ENDURO TT 125	125	93		FD138	1	DF677	W	FLW	FLS	FD075	DF678	WLL	WS
HALLEY 125	125	09		FD164	1	DF677	W	FLW	FLS	FD093	DF678	WLL	WS
HALLEY 125 SM	125	09		FD068	1					FD093			
JT 12 125	125	95		FD065	1					FD065			
MC 125	125	94	00	FD138	1	DF677	W	FLW	FLS	FD074	DF678	WLL	WS
MC 125	125	01		FD164	1	DF677	W	FLW	FLS	FD093	DF678	WLL	WS
SM 125	125	01	04	FD107	1					FD093			
SM 125	125	05		FD068	1					FD093			
TRIAL 125 4T	125	11		FD223	1					MF	-		
TRIAL GP 125	125	19		FD511	1	DF808	W			FD224	DF809	W	
TT 125	125	95		FD138	1	DF677	W	FLW	FLS	FD165	DF678	WLL	WS
TXT 125	125	99	03	FD225	1					FD225			
TXT 125	125	04		FD223	1					FD224			
TXT PRO RACING 125	125	12	13	FD446	1	DF808	W			FD224	DF809	W	
TXT PRO RACING 125	125	14	18	FD460	1	DF808	W			FD224	DF809	W	
TXT PRO RACING 125	125	19		FD511	1	DF808	W			FD224	DF809	W	
JTR 140 CONTACT	140	96		FD065	1					FD065			
JT 16 150	150	95		FD065	1					FD065			
JT 160	160	95		FD065	1					FD065			



APPLICATIONS
 PADS FD
 DISCS DF
 SHOES MF
 LINES FK
 BRACKETS SP
 KITS KG
 CROSS REFERENCE



APPLICATIONS

PADS FD

DISCS DF

SHOES MF

LINES FK

BRACKETS SP

KITS KG

CROSS REFERENCE

BRAND & MODEL · MARCA Y MODELO MARCA E MODELLO · MARQUE ET MODÈLE	C.C.	YEAR	FRONT					REAR					KITS
			FD MF	Nº	DF	OE	UPGRADE 1	UPGRADE 2	FD MF	DF	OE	UPGRADE	
continue GAS GAS													
200 PAMPERA	200	99	FD065	1						FD065			
EC 200	200	99	00	FD138	1	DF677	W	FLW	FLS	FD165	DF678	WLL	WS
EC 200	200	01		FD164	1	DF677	W	FLW	FLS	FD093	DF678	WLL	WS
EC 200 SIX DAYS	200	11		FD164	1	DF677	W	FLW	FLS	FD286	DF678	WLL	WS
TXT 200	200	99		FD225	1					FD225			
250 PAMPERA	250	96	02	FD065	1					FD065			
250 PAMPERA	250	03		FD162	1	DF674	W	FLW		FD225			
CONTAC JT 250	250	94		FD065	1					FD065			
CONTAC T25	250	93	93	FD065	1					FD065			
EC 250	250	95	98	FD138	1	DF677	W	FLW	FLS	FD075	DF678	WLL	WS
EC 250	250	99	00	FD138	1	DF677	W	FLW	FLS	FD165	DF678	WLL	WS
EC 250	250	01		FD164	1	DF677	W	FLW	FLS	FD093	DF678	WLL	WS
EC 250 E	250	11		FD164	1	DF677	W	FLW	FLS	FD286	DF678	WLL	WS
EC 250 F	250	10		FD164	1	DF677	W	FLW	FLS	FD286	DF678	WLL	WS
EC 250 FSE	250	01		FD164	1	DF677	W	FLW	FLS	FD093	DF678	WLL	WS
EC 250 RACING	250	09		FD164	1	DF677	W	FLW	FLS	FD093	DF678	WLL	WS
EC 250 SIX DAYS	250	11		FD164	1	DF677	W	FLW	FLS	FD286	DF678	WLL	WS
EC 250 YR	250	12		FD164	1	DF677	W	FLW	FLS	FD286	DF678	WLL	WS
FSE 250 4T	250	99		FD138	1	DF677	W	FLW	FLS	FD165	DF678	WLL	WS
JT 25	250	91		FD065	1					FD065			
JTR 250 CONTACT	250	96		FD065	1					FD065			
MC 250	250	95	98	FD138	1	DF677	W	FLW	FLS	FD075	DF678	WLL	WS
MC 250	250	99	00	FD138	1	DF677	W	FLW	FLS	FD165	DF678	WLL	WS
MC 250	250	01		FD164	1	DF677	W	FLW	FLS	FD093	DF678	WLL	WS
SM 250	250	01		FD107	1					FD093			
TRIAL GP 250	250	19		FD511	1	DF808	W			FD224	DF809	W	
TT 250	250	95		FD138	1	DF677	W	FLW	FLS	FD165	DF678	WLL	WS
TXT 250	250	99	02	FD225	1					FD225			
TXT 250	250	03	03	FD223	1					FD224			
TXT 250	250	04		FD223	1	DF808	W			FD224	DF809	W	
TXT PRO RACING 250	250	12	13	FD446	1	DF808	W			FD224	DF809	W	
TXT PRO RACING 250	250	14	18	FD460	1	DF808	W			FD224	DF809	W	
TXT PRO RACING 250	250	19		FD511	1	DF808	W			FD224	DF809	W	
JTR 270 CONTACT	270	96	97	FD065	1					FD065			
TXT 270	270	98	98	FD065	1					FD065			
TXT 270	270	99	01	FD225	1					FD225			
TRIAL GP 280	280	19		FD511	1	DF808	W			FD224	DF809	W	
TXT 280	280	00	02	FD225	1					FD225			
TXT 280	280	03	03	FD223	1					FD224			
TXT 280	280	04		FD223	1	DF808	W			FD224	DF809	W	
TXT PRO RACING 280	280	12	13	FD446	1	DF808	W			FD224	DF809	W	
TXT PRO RACING 280	280	14	18	FD460	1	DF808	W			FD224	DF809	W	
TXT PRO RACING 280	280	19		FD511	1	DF808	W			FD224	DF809	W	
EC 300	300	99	00	FD138	1	DF677	W	FLW	FLS	FD165	DF678	WLL	WS
EC 300	300	01		FD164	1	DF677	W	FLW	FLS	FD093	DF678	WLL	WS
EC 300 E	300	11		FD164	1	DF677	W	FLW	FLS	FD286	DF678	WLL	WS
EC 300 F	300	15		FD164	1	DF677	W	FLW	FLS	FD286	DF678	WLL	WS
EC 300 RACING	300	09		FD164	1	DF677	W	FLW	FLS	FD286	DF678	WLL	WS
EC 300 SIX DAYS	300	11		FD164	1	DF677	W	FLW	FLS	FD286	DF678	WLL	WS
TRIAL GP 300	300	19		FD511	1	DF808	W			FD224	DF809	W	
TXT 300	300	04		FD223	1	DF808	W			FD224	DF809	W	
TXT PRO RACING 300	300	14	18	FD460	1	DF808	W			FD224	DF809	W	
TXT PRO RACING 300	300	19		FD511	1	DF808	W			FD224	DF809	W	
320 PAMPERA	320	99		FD065	1					FD065			
JT 32	320	91		FD065	1					FD065			
TXT 321	321	99		FD225	1					FD225			
JT 350	350	95		FD065	1					FD065			
JTR 370 CONTACT	370	96		FD065	1					FD065			
EC 400 FSE	400	99	00	FD138	1	DF677	W	FLW	FLS	FD165	DF678	WLL	WS
EC 400 FSE	400	01		FD164	1	DF677	W	FLW	FLS	FD093	DF607	W	WLL
ENDUCAMP 400 4T	400	05		FD162	1	DF677	W	FLW	FLS	FD093	DF678	WLL	WS
PAMPERA 400	400	06		FD164	1	DF677	W	FLW	FLS	FD093	DF678	WLL	WS
SM 400	400	01		FD107	1					FD093			
EC 450 F	450	15		FD164	1	DF677	W	FLW	FLS	FD286	DF678	WLL	WS
EC 450 FSE	450	03		FD164	1	DF677	W	FLW	FLS	FD093	DF678	WLL	WS
EC 450 RAID	450	15		FD164	1	DF677	CW			FD286	DF678	WLL	WS
FSR 450	450	07		FD068	1					FD093	DF678	WLL	WS
HALLEY 450	450	09		FD409	1	DF677	W	FLW	FLS	FD252	DF678	WLL	WS
HALLEY 450 SM	450	09		FD409	1	DF677	W	FLW	FLS	FD093	DF678	WLL	WS
SM 450	450	05		FD068	1					FD093	DF678	WLL	WS
GAS GAS 4 Wheels													
J 50	50	06		MF		-				FD065			





BRAND & MODEL · MARCA Y MODELO MARCA E MODELLO · MARQUE ET MODÈLE	C.C.	YEAR	FRONT						REAR				KITS KG
			FD _{MF}	N°	DF	OE	UPGRADE 1	UPGRADE 2	FD _{MF}	DF	OE	UPGRADE	
continue GAS GAS 4 Wheels													
HP WILD 50	50	03	FD138	2	DF742	W			FD138	DF743	W		
HP WILD 240	240	03	FD138	2	DF742	W			FD138	DF743	W		
KS 250 RV IZQ.	250	06	FD086	2									
KS 250 RV DER.	250	06	FD117	2					FD				
HP WILD 300	300	03	FD138	2	DF742	W			FD138	DF743	W		
HP WILD 450	450	03	FD138	2	DF742	W			FD138	DF743	W		
HP WILD 515	515	09	FD138	2	DF742	W			FD138	DF743	W		
GENERIC													
EPICO ELECTRIC	EL	12	FD175	1					MF	-			
TTX	EL	16	FD073	1					FD073				
VIONIS	EL	18	FD073	1					FD073				
CLASSIC	50	17	FD073	1					MF	-			
EPICO	50	10	FD175	1					MF458	-			
IDEO	50	05	FD175	1	DF649	W			MF458	-			
ONIX	50	10	FD153	1					MF458	-			
PANDORA	50	13	FD153	1					MF				
ROC	50	08	FD175	1	DF649	W			MF458	-			
TOXIC 50	50	07	FD162	1					FD048				
TRIGGER SM 50	50	06	FD162	1					FD048				
TRIGGER X 50	50	06	FD162	1					FD048				
XOR	50	05	FD175	1	DF649	W			MF458	-			
XOR 2	50	10	FD175	1	DF649	W			MF458	-			
MADISON 110	110	13	FD073	1					MF	-			
VENOS 110	110	13	FD073	1					MF	-			
CODE S	125	12	FD538	1					FD228				
CODE X	125	12	FD538	1					FD228				
IDEO 125	125	05	FD175	1	DF649	W			MF458	-			
SOHO 125	125	06	FD175	1					MF	-			
TR 125 SM	125	17	FD187	1					FD228				
TRIGER 125 SM	125	08	FD162	1					FD048				
TW 125 SM	125	17	FD266	1					FD228				
XOR 125	125	05	FD175	1	DF649	W			MF458	-			
ZION 125	125	08	FD187	1					MF	-			
CODE S	150	12	FD538	1					FD228				
CODE X	150	12	FD538	1					FD228				
WORX	150	12	FD145	1					FD228				
ZION 150	150	08	FD187	1					MF				
ZION 150	150	11	FD187	1					FD187				
CODE S	200	12	FD538	1					FD228				
CODE X	200	12	FD538	1					FD228				
GRS 600	600	13	FD262	1					FD220				
GILERA-PIAGGIO													
50 R	50	93	FD153	1	DF629	W	RW	FLS	MF	-			
50 RT FUN	50	93	FD153	1	DF629	W	RW	FLS	MF	-			
50 TYPHOON	50	93	FD153	1	DF629	W	RW	FLS	MF621	-			
50 VX 10	50	92	FD075	1					FD075				
DNA 50 (G)	50	00	FD162	1	DF666	W			FD200	DF362	W		
DNA 50 (H)	50	00	FD277	1	DF666	W			FD200	DF362	W		
EAGLET, 6V	50	96	FD152	1					FD135				
GP 50	50	02	FD133	1					FD065				
GPR 50 POGGIALI REPLICA	50	03	FD133	1					FD065				
GSM 50	50	00	FD065	1					FD065				
H@K 50	50	01	FD065	1					FD065				
ICE 50	50	01	FD153	1					MF	-			
NRG MC2	50	98	00	FD153	1	DF629	W	RW	FLS	FD200	DF705	W	
NRG MC3	50	01	FD153	1	DF629	W	RW	FLS	FD200	DF705	W		
OFF ROAD R SIX SPEED 50	50	97	FD065	1					FD065				
RCR 50	50	04	FD065	1					FD065				
RUNNER 50	50	97	97	FD153	1	DF737	W		MF636	-			
RUNNER 50 DD	50	98	FD153	1	DF737	W			FD200	DF705	W		
RUNNER 50 SP	50	98	04	FD153	1	DF737	W		FD200	DF705	W		
RUNNER 50 SP	50	05	05	FD135	1	DF737	W		FD200	DF705	W		
RUNNER 50 SP / PJ	50	06	FD277	1	DF737	W			FD200	DF705	W		
STALKER 50	50	97	FD153	1	DF629	W	RW	FLS	FD200	DF705	W		
SURFER 50	50	00	FD065	1					MF	-			
ZULU 50	50	01	FD065	1					FD065				
125 APACHE	125	92	FD089	1					FD079				
125 CRONO AE	125	91	FD118	1					FD012				
125 CX, AE	125	91	FD118	1					FD012				
125 FREESTYLE	125	92	FD118	1					FD012				
125 GFR	125	93	94	FD118	1	DF660	CW	CRW	FD012				
125 RC	125	90	FD089	1					FD012				



APPLICATIONS
 PADS FD
 DISCS DF
 SHOES MF
 LINES FK
 BRACKETS SP
 KITS KG
 CROSS REFERENCE



APPLICATIONS

PADS FD

DISCS DF

SHOES MF

LINES FK

BRACKETS SP

KITS KG

CROSS REFERENCE

BRAND & MODEL · MARCA Y MODELO MARCA E MODELLO · MARQUE ET MODÈLE	C.C.	YEAR	FRONT					REAR				KITS KG	
			FD _{MF}	N°	DF	OE	UPGRADE 1	UPGRADE 2	FD _{MF}	DF	OE		UPGRADE
continue GILERA-PIAGGIO													
125 SATURNO PIUMA	125	90	FD068	1						FD065			
125 SP02	125	90	FD118	1						FD012			
125 TYPHOON	125	95	FD153	1	DF629	W	RW	FLS		MF621	-		
COUGAR 125	125	01	FD074	1						MF	-		
DNA 125 (G)	125	01	FD162	1	DF666	W				FD263	DF666	W	
DNA 125 (H)	125	01	FD277	1	DF666	W				FD263	DF666	W	
NEXUS	125	07	FD277	1	DF667	W				FD277	DF666	W	
NEXUS i.e.	125	09	FD277	1	DF667	W				FD277	DF666	W	
RUNNER 125 FX (G)	125	97	98	FD162	1	DF737	W			MF	-		
RUNNER 125 FX (H)	125	97	98	FD277	1	DF737	W			MF	-		
RUNNER 125 SP	125	99	00	FD162	1	DF737	W			FD200	DF666	W	
RUNNER 125 VX (G)	125	01		FD162	1	DF737	W			FD263	DF666	W	
RUNNER 125 VX (H)	125	01		FD277	1	DF737	W			FD263	DF666	W	
SC 125	125	06		FD341	1					FD065			
DNA 180 (G)	180	01		FD162	1	DF666	W			FD263	DF666	W	
DNA 180 (H)	180	01		FD277	1	DF666	W			FD263	DF666	W	
MAD-MUD (G)	180	02		FD162	1					FD263			
MAD-MUD (H)	180	02		FD277	1					FD263			
RUNNER 180 FXR (G)	180	98	98	FD162	1	DF737	W			MF	-		
RUNNER 180 FXR (H)	180	98	98	FD277	1	DF737	W			MF	-		
RUNNER 180 SP	180	99	00	FD162	1	DF737	W			FD200	DF666	W	
RUNNER 180 VXR (G)	180	01		FD162	1	DF737	W			FD263	DF666	W	
RUNNER 180 VXR (H)	180	01		FD277	1	DF737	W			FD263	DF666	W	
RUNNER 200 VXR	200	02	05	FD162	1	DF737	W			FD263			
RUNNER 200 VXR	200	06		FD277	1					FD263			
NEXUS i.e.	250	06	06	FD138	2	DF667	W			FD220	DF666	W	
NEXUS i.e.	250	07		FD277	1	DF667	W			FD263	DF666	W	
NEXUS i.e.	300	09		FD277	1	DF667	W			FD277	DF666	W	
350 NORTHWEST	491	94		FD119	1					FD012			
500 SATURNO PIUMA	500	90		FD068	1					FD065			
FUOCO 500 i.e.	500	07		FD200	2	DF714	W			FD536	DF666	W	
NEXUS	500	03	05	FD138	2	DF667	W			FD220	DF666	W	
NEXUS i.e. SP	500	06		FD138	2	DF667	W			FD220	DF666	W	
600 NORTHWEST	600	91		FD118	2					FD012			
600 RC FOUR VALVE	600	91		FD089	1					FD079			
600 SUPERSPORT	600	02		FD262	2	DF660	CW	CRW		FD220			
600 XRT	600	90		FD089	1					FD012			
RC 600 R	600	92	93	FD089	1					FD079			
RC 600 R, COBRA	600	94		FD118	1					FD170			
GP 800	800	08		FD138	2					FD277			
GP 850 CORSA	850	09		FD262	2					FD165			
(G) CALIPER GRIMECA													
(H) CALIPER HENG TONG													
GOES 4 Wheels													
GS 50 X	50	08		FD133	2					FD133			
GS 125 BIG WHEEL	125	08		FD073	2					FD145			
G 125 X	125			FD073	2					FD073			
G 125 XM	125			FD164	2					FD093			
G 250 XM	125			FD164	2					FD093			
350 S	350			FD094	2					FD075			
360 MAX	360			FD	2					FD			
520 2X4/4X4	520			FD	2					FD			
520 MAX	520			FD	2					FD			
720 MAX	720			FD	2					FD			
GOVECS													
GO ! S1.2	EL	10		FD065	1	DF649	W			MF	-		
GRIMECA													
RADIAL SCOOTER		04		FD338									
HARLEY DAVIDSON													
PARA LLANTAS CHISEL / FOR CHISEL RIMS						DF932	W				DF932	W	
PARA LLANTAS SLICER / FOR SLICER RIMS						DF932	W				DF932	W	
SERIE ELECTRICA													
LIVE WIRE	EL			FD475	2	DF838	W	V		FD220			
SERIE CVO													
CVO BREAKOUT	1801	13		FD405	2	DF835	CW	FLV		FD406	DF836	W	FLV
CVO LIMITED	1801	14		FD369	2	DF835	CW	FLV		FD369	DF836	W	FLV
CVO PRO STREET BREAKOUT	1801	14		FD219	2	DF835	CW	FLV		FD406	DF836	W	FLV
CVO ROAD GLIDE ULTRA	1801	11		FD369	2	DF835	CW	FLV		FD369	DF836	W	FLV
CVO ROAD KING	1801	14		FD369	2	DF835	CW	FLV		FD369	DF836	W	FLV
CVO SOFTAIL DELUXE	1801	14		FD405	2	DF835	CW	FLV		FD406	DF836	W	FLV
CVO SOFTAIL DELUXE	1801	15		FD219	2	DF835	CW	FLV		FD406	DF836	W	FLV
CVO STREET GLIDE	1801	10		FD369	2	DF835	CW	FLV		FD369	DF836	W	FLV



BRAND & MODEL · MARCA Y MODELO MARCA E MODELLO · MARQUE ET MODÈLE	C.C.	YEAR	FRONT						REAR				KITS	
			FD MF	N°	DF	OE	UPGRADE 1	UPGRADE 2	FD MF	DF	OE	UPGRADE	KG	
continue HARLEY DAVIDSON														
SERIE DYNA														
FXD SUPER GLIDE	1340	00	FD235	1	DF680	W	FLV	FLW	FD235	DF681	W	FLV		
FXDL LOW RIDER	1340	00	FD235	2	DF680	W	FLV	FLW	FD235	DF681	W	FLV		
FXDSCON DYNA CONVER	1340	00	FD235	2	DF680	W	FLV	FLW	FD235	DF681	W	FLV		
FXDWG WIDE GLIDE	1340	00	07	FD235	1	DF680	W	FLV	FLW	FD235	DF681	W	FLV	
FXDX SUPER GLIDE SPORT	1340	00	FD235	2	DF680	W	FLV	FLW	FD235	DF681	W	FLV		
FXDXT SUPER GLIDE T SPORT	1340	01	FD375	2	DF680	W	FLV	FLW	FD235	DF681	W	FLV		
FXD SUPER GLIDE (cast wheel)	1450	08	FD405	1	DF835	CW	FLV		FD406	DF681	W	FLV		
FXD SWITCHBACK	1450	12	FD405	1	DF835	CW	FLV		FD406	DF681	W	FLV		
FXDBi STREET BOB	1450	06	07	FD235	1	DF835	CW	FLV	FD235	DF681	W	FLV		
FXDBi STREET BOB	1450	08	FD235	1	DF835	CW	FLV		FD406	DF681	W	FLV		
FXDCi SUPER GLIDE CUSTOM	1450	05	FD235	1	DF835	CW	FLV		FD235	DF681	W	FLV		
FXDCi SUPER GLIDE CUSTOM (cast wheel)	1450	06	FD235	1	DF835	CW	FLV		FD235	DF681	W	FLV		
FXDCi SUPER GLIDE CUSTOM DYNA	1450	06	07	FD235	1	DF835	CW	FLV	FD235	DF681	W	FLV		
FXDCi SUPER GLIDE CUSTOM DYNA	1450	08	FD405	1	DF835	CW	FLV		FD406	DF681	W	FLV		
FXDF FAT BOB (cast wheel)	1450	08	FD405	1	DF835	CW	FLV		FD406	DF681	W	FLV		
FXDi 35th ANIVERSARIO SUPER GLIDE	1450	06	FD235	1	DF835	CW	FLV		FD235	DF681	W	FLV		
FXDi SUPER GLIDE	1450	04	05	FD235	1	DF680	W	FLV	FLW	FD235	DF681	W	FLV	
FXDi SUPER GLIDE (cast wheel)	1450	06	FD235	1					FD235	DF681	W	FLV		
FXDLi LOW RIDER	1450	04	05	FD235	1	DF680	W	FLV	FLW	FD235	DF681	W	FLV	
FXDLi LOW RIDER (cast wheel)	1450	06	07	FD235	1	DF835	CW	FLV	FD235	DF681	W	FLV		
FXDLi LOW RIDER (cast wheel)	1450	08	FD405	1	DF835	CW	FLV		FD406	DF681	W	FLV		
FXDLi LOW RIDER DYNA	1450	06	FD235	1	DF835	CW	FLV		FD235	DF681	W	FLV		
FXDWG DYNA WIDE GLIDE	1450	06	06	FD235	1	DF835	CW	FLV	FD235	DF681	W	FLV		
FXDWG DYNA WIDE GLIDE	1450	07	FD405	1	DF835	CW	FLV		FD406	DF681	W	FLV		
FXDWG WIDE GLIDE	1450	08	FD405	1	DF835	CW	FLV		FD406	DF681	W	FLV		
FXDWGi WIDE GLIDE	1450	04	05	FD235	1	DF680	W	FLV	FLW	FD235	DF681	W	FLV	
FXDWGi WIDE GLIDE DYNA	1450	06	09	FD235	1	DF835	CW	FLV	FD235	DF681	W	FLV		
FXDWGi WIDE GLIDE DYNA	1450	10	FD405	1	DF835	CW	FLV		FD406	DF681	W	FLV		
FXDXi SUPER GLIDE SPORT	1450	04	FD235	2	DF680	W	FLV	FLW	FD235	DF681	W	FLV		
FXDB DYNA STREET BOB	1690	14	FD405	1	DF835	CW	FLV		FD406	DF836	W	FLV		
FXDBA DYNA STREET BOB	1690	13	FD405	1	DF835	CW	FLV		FD406	DF836	W	FLV		
FXDBB DYNA STREET BOB	1690	14	FD405	1	DF835	CW	FLV		FD406	DF836	W	FLV		
FXDBP DYNA STREET BOB	1690	13	FD405	1	DF835	CW	FLV		FD406	DF836	W	FLV		
FXDC DYNA SUPER GLIDE	1690	14	FD405	1	DF835	CW	FLV		FD406	DF836	W	FLV		
FXDF DYNA WIDE GLIDE	1690	12	FD405	1	DF835	CW	FLV		FD406	DF836	W	FLV		
FXDF FAT BOB (cast wheel)	1690	12	FD405	1	DF835	CW	FLV		FD406	DF836	W	FLV		
FXDL DYNA LOW RIDER	1690	14	FD405	2	DF821	PW	FLV		FD406	DF836	W	FLV		
FXS BLACKLINE	1690	13	FD405	1					FD406					
FXSB BREAKOUT	1690	14	14	FD405	1	DF835	CW	FLV	FD406	DF836	W	FLV		
FXSB BREAKOUT	1690	15	FD219	1	DF835	CW	FLV		FD406	DF836	W	FLV		
SERIE SOFTAIL														
FLSTC/i HERITAGE CLASSIC	1340	00	FD235	1	DF680	W	FLV	FLW	FD235	DF681	W	FLV		
FLSTF/i FAT BOY	1340	00	06	FD235	1	DF680	W	FLV	FLW	FD235	DF681	W	FLV	
FLSTi FAT BOY 15th ANIVERSARIO	1340	05	FD235	1	DF680	W	FLV	FLW	FD235	DF681	W	FLV		
FLSTS HERITAGE SPRINGER	1340	00	FD124	1	DF680	W	FLV	FLW	FD235	DF681	W	FLV		
FXST/i SOFTAIL STANDARD	1340	00	05	FD235	1	DF680	W	FLV	FLW	FD235	DF682	W	FLV	
FXSTB/i NIGHT TRAIN	1340	00	05	FD235	1	DF680	W	FLV	FLW	FD235	DF681	W	FLV	
FXSTD/i SOFTAIL DEUCE	1340	00	FD235	1	DF680	W	FLV	FLW	FD235	DF681	W	FLV		
FXSTS/i SOFTAIL SPRINGER	1340	00	FD124	1	DF680	W	FLV	FLW	FD235	DF681	W	FLV		
FLS SOFTAIL SLIM	1450	12	FD405	1	DF680	W	FLV	FLW	FD406	DF681	W	FLV		
FLST/i HERITAGE SOFTAIL	1450	06	FD235	1	DF680	W	FLV	FLW	FD235	DF681	W	FLV		
FLSTC HERITAGE CLASSIC SOFTAIL	1450	07	07	FD235	1	DF680	W	FLV	FLW	FD235	DF681	W	FLV	
FLSTC HERITAGE CLASSIC SOFTAIL	1450	08	14	FD405	1	DF680	W	FLV	FLW	FD406	DF681	W	FLV	
FLSTC HERITAGE CLASSIC SOFTAIL	1450	15	FD219	1	DF835	CW	FLV		FD406	DF681	W	FLV		
FLSTF FAT BOY	1450	08	15	FD405	1	DF680	W	FLV	FLW	FD406	DF681	W	FLV	
FLSTF FAT BOY	1450	16	FD219	1	DF835	CW	FLV		FD406	DF681	W	FLV		
FLSTF/i FAT BOY	1450	07	07	FD235	1	DF680	W	FLV	FLW	FD235	DF681	W	FLV	
FLSTFB FAT BOY SPECIAL	1450	10	FD405	1	DF680	W	FLV	FLW	FD406	DF681	W	FLV		
FLSTN/i SOFTAIL DE LUXE	1450	05	07	FD235	1	DF680	W	FLV	FLW	FD235	DF681	W	FLV	
FLSTN/i SOFTAIL DE LUXE	1450	08	14	FD405	1	DF680	W	FLV	FLW	FD406	DF681	W	FLV	
FLSTN/i SOFTAIL DE LUXE	1450	15	FD405	1	DF835	CW	FLV		FD406	DF681	W	FLV		
FLSTSB SOFTAIL CROSS BONES	1450	08	FD124	1	DF680	W	FLV	FLW	FD235	DF681	W	FLV		
FLSTSC/i SPRINGER CLASSIC	1450	05	FD124	1	DF680	W	FLV	FLW	FD235	DF681	W	FLV		
FLSTSC/i SPRINGER CLASSIC SOFTAIL	1450	06	FD124	1	DF680	W	FLV	FLW	FD375	DF681	W	FLV		
FXCW ROCKER	1450	08	FD405	1	DF680	W	FLV	FLW	FD406	DF681	W	FLV		
FXCWC ROCKER C	1450	08	FD405	1	DF680	W	FLV	FLW	FD406	DF681	W	FLV		
FXS BLACKLINE	1450	11	FD405	1	DF680	W	FLV	FLW	FD406	DF681	W	FLV		
FXST/i SOFTAIL STANDARD	1450	06	07	FD235	1	DF680	W	FLV	FLW	FD235	DF681	W	FLV	
FXST/i SOFTAIL STANDARD	1450	08	14	FD405	1	DF680	W	FLV	FLW	FD406	DF681	W	FLV	
FXST/i SOFTAIL STANDARD	1450	15	FD219	1	DF835	CW	FLV		FD406	DF681	W	FLV		
FXSTB/i NIGHT TRAIN SOFTAIL	1450	06	07	FD235	1	DF680	W	FLV	FLW	FD235	DF681	W	FLV	





BRAND & MODEL · MARCA Y MODELO MARCA E MODELLO · MARQUE ET MODÈLE	C.C.	YEAR	FRONT						REAR				KITS KG
			FD _{MF}	Nº	DF	OE	UPGRADE 1	UPGRADE 2	FD _{MF}	DF	OE	UPGRADE	
continue HARLEY DAVIDSON													
FXSTB/i NIGHT TRAIN SOFTAIL	1450	08	FD405	1	DF680	W	FLV	FLW	FD406	DF681	W	FLV	
FXSTC SOFTAIL CUSTOM	1450	07 07	FD235	1	DF680	W	FLV	FLW	FD235	DF681	W	FLV	
FXSTC SOFTAIL CUSTOM	1450	08	FD405	1	DF680	W	FLV	FLW	FD406	DF681	W	FLV	
FLS SOFTAIL SLIM	1584	12 14	FD405	1	DF835	CW	FLV		FD406	DF681	W	FLV	
FLS SOFTAIL SLIM	1584	15	FD219	1	DF835	CW	FLV		FD406	DF681	W	FLV	
FLD SWITCHBACK	1690	12	FD405	1	DF821	PW	PV		FD406	DF681	W	FLV	
FLSTF FAT BOY	1690	12 14	FD405	1	DF835	CW	FLV		FD406	DF681	W	FLV	
FLSTF FAT BOY	1690	15	FD219	1	DF835	CW	FLV		FD406	DF836	W	FLV	
FLSTF FAT BOY SPECIAL	1690	12 14	FD405	1	DF835	CW	FLV		FD406	DF681	W	FLV	
FLSTFB FAT BOY	1690	12 14	FD405	1	DF835	CW	FLV		FD406	DF681	W	FLV	
FLSTFB FAT BOY	1690	15	FD219	1	DF835	CW	FLV		FD406	DF836	W	FLV	
FLSTN SOFTAIL DELUXE	1690	12 14	FD405	1	DF835	CW	FLV		FD406	DF836	W	FLV	
FLSTN SOFTAIL DELUXE	1690	15	FD219	1	DF835	CW	FLV		FD406	DF836	W	FLV	
FLTRX ROAD GLIDE	1690	15	FD369	2	DF821	PW	PV		FD369	DF836	W	FLV	
FLTRX ROAD GLIDE SPECIAL	1690	15	FD369	2	DF821	PW	PV		FD369	DF836	W	FLV	
FXSB BREAKOUT	1690	13 14	FD405	1	DF680	W	FLV	FLW	FD406	DF681	W	FLV	
FXSB BREAKOUT	1690	15	FD405	1	DF835	CW	FLV		FD406	DF681	W	FLV	
FLDE DELUXE	1745	18	FD219	1					FD542				
FLFB FAT BOY 104	1745	18	FD219	1					FD542				
FLHC HERITAGE CLASSIC 107	1745	18	FD219	1					FD542				
FLS SOFTAIL SLIM	1745	18	FD219	1					FD542				
FXBB STREET BOB	1745	18	FD219	1					FD542				
FXBR BREAKOUT 107	1745	18	FD219	2					FD542				
FXFBS FAT BOB 107	1745	18	FD219	1					FD542				
FXLR LOW RIDER	1745	18	FD219	1					FD542				
SPORT GLIDE	1868	18	FD219	2					FD542				
FLFB FAT BOY 114	1868	18	FD219	1					FD542				
FLHC HERITAGE CLASSIC 114	1868	18	FD219	1					FD542				
FXFBS FAT BOB 114	1868	18	FD219	1	DF835	CW	FLV		FD542				
FXBRS BREAKOUT 114	1868	18	FD219	1	DF835	CW	FLV		FD542				
SERIE SPORTSTER													
XL 50th ANIVERSARIO	883	07	FD339	1	DF680	W	FLV	FLW	FD340	DF681	W	FLV	
XL IRON	883	09 10	FD339	1	DF680	W	FLV	FLW	FD340	DF681	W	FLV	
XL IRON	883	11 13	FD339	1	DF680	W	FLV	FLW	FD340	DF836	W	FLV	
XL IRON	883	14	FD	1	DF835	CW	FLV		FD267	DF836	W	FLV	
XL ROADSTER	883	10	FD339	2	DF680	W	FLV	FLW	FD340	DF724	W	FLV	
XL SPORTSTER CUSTOM	883	00 03	FD235	1	DF680	W	FLV	FLW	FD235	DF681	W	FLV	
XL SPORTSTER CUSTOM	883	04	FD339	1	DF680	W	FLV	FLW	FD340	DF681	W	FLV	
XL SPORTSTER HUGGER	883	00	FD235	1	DF680	W	FLV	FLW	FD235	DF681	W	FLV	
XL SPORTSTER LOW	883	04 13	FD339	1	DF680	W	FLV	FLW	FD340	DF724	W	FLV	
XL SPORTSTER LOW	883	14	FD339	1	DF835	CW	FLV		FD340	DF724	W	FLV	
XL SPORTSTER R	883	05	FD339	2	DF680	W	FLV	FLW	FD340	DF724	W	FLV	
XL SPORTSTER STANDARD	883	04	FD339	1	DF680	W	FLV	FLW	FD340	DF681	W	FLV	
XLH SPORTSTER	883	00	FD235	1	DF680	W	FLV	FLW	FD235	DF681	W	FLV	
XLH SPORTSTER R	883	00 04	FD235	1	DF680	W	FLV	FLW	FD235	DF681	W	FLV	
XLH SPORTSTER R	883	05	FD339	1	DF680	W	FLV	FLW	FD340	DF681	W	FLV	
XL L SUPERLOW	883	11 13	FD339	1	DF680	W	FLV	FLW	FD340	DF681	W	FLV	
XL L SUPERLOW	883	14	FD339	1	DF835	CW	FLV		FD340	DF836	W	FLV	
XL NIGHTSTER	1200	08	FD339	1	DF680	W	FLV	FLW	FD340	DF681	W	FLV	
XL ROADSTER	1200	04 13	FD339	2	DF680	W	FLV	FLW	FD340	DF681	W	FLV	
XL ROADSTER	1200	14	FD	2	DF835	CW	FLV		FD267	DF836	W	FLV	
XL SPORTSTER CUSTOM	1200	00 03	FD235	1	DF680	W	FLV	FLW	FD235	DF681	W	FLV	
XL SPORTSTER CUSTOM	1200	04 10	FD339	1	DF680	W	FLV	FLW	FD340	DF681	W	FLV	
XL SPORTSTER CUSTOM	1200	11 13	FD339	1	DF680	W	FLV	FLW	FD340	DF836	W	FLV	
XL SPORTSTER CUSTOM	1200	14	FD	2	DF835	CW	FLV		FD267	DF724	W	FLV	
XL SPORTSTER LOW	1200	07	FD339	1	DF680	W	FLV	FLW	FD340	DF724	W	FLV	
XL SPORTSTER SPORT	1200	00	FD235	1	DF680	W	FLV	FLW	FD235	DF681	W	FLV	
XL T LOW	1200	14	FD	2	DF835	CW	FLV		FD267	DF836	W	FLV	
XL 1200 V SEVENTY-TWO	1200	12 13	FD339	1	DF680	W	FLV	FLW	FD340	DF724	W	FLV	
XL 1200 V SEVENTY-TWO	1200	14	FD	2	DF835	CW	FLV		FD267	DF836	W	FLV	
XL 1200 X FORTY EIGHT	1200	10 13	FD339	1	DF680	W	FLV	FLW	FD340	DF724	W	FLV	
XL 1200 X FORTY EIGHT	1200	14	FD	2	DF835	CW	FLV		FD267	DF836	W	FLV	
XR 1200	1200	08 10	FD219	2	DF680	W	FLV	FLW	FD340	DF724	W	FLV	
XR 1200 R	1200	10	FD219	2	DF680	W	FLV	FLW	FD340	DF724	W	FLV	
XR 1200 STORZ	1200	10	FD219	2	DF680	W	FLV	FLW	FD340	DF691	FLW		
XR 1200 X	1200	10	FD219	2	DF680	W	FLV	FLW	FD340	DF724	W	FLV	
SERIE TOURING													
FLHR SERIES	1340	94 99	FD124	2	DF679	W	FLV		FD125				
FLHR/i ROAD KING	1340	00 07	FD235	2	DF680	W	FLV	FLW	FD235	DF681	W	FLV	
FLHR/i ROAD KING	1340	08	FD369	2	DF835	CW	FLV		FD369	DF681	W	FLV	
FLHRCI SERIES	1340	94 99	FD124	2	DF679	W	FLV		FD125				
FLHRS/i ROAD KING CUSTOM	1340	04 07	FD235	2	DF680	W	FLV	FLW	FD235	DF681	W	FLV	





BRAND & MODEL · MARCA Y MODELO MARCA E MODELLO · MARQUE ET MODÉLE	C.C.	YEAR	FRONT							REAR				KITS KG
			FD _{MF}	N°	DF	OE	UPGRADE 1	UPGRADE 2	FD _{MF}	DF	OE	UPGRADE		
continue HARLEY DAVIDSON														
FLHT/i ELECTRA GLIDE STANDARD	1340	00	07	FD235	2	DF680	W	FLV	FLW	FD235	DF681	W	FLV	
FLHTC/i ELECTRA GLIDE CLASSIC	1340	04	07	FD235	2	DF680	W	FLV	FLW	FD235	DF681	W	FLV	
FLHTC/i ELECTRA GLIDE CLASSIC	1340	08		FD369	2	DF835	CW	FLV		FD369	DF836	W	FLV	
FLHTCU ELECTRA GLIDE ULTRA CLASSIC	1340	00	07	FD235	2	DF680	W	FLV	FLW	FD235	DF681	W	FLV	
FLTR/i ROAD GLIDE	1340	00	07	FD235	2	DF680	W	FLV	FLW	FD235	DF681	W	FLV	
FLHR ROAD KING	1450	08		FD369	2	DF835	CW	FLV		FD369	DF836	W	FLV	
FLHRC ROAD KING CLASSIC	1450	08		FD369	2	DF835	CW	FLV		FD369	DF836	W	FLV	
FLHT ELECTRA GLIDE STANDARD	1450	08		FD369	2	DF835	CW	FLV		FD369	DF836	W	FLV	
FLHTC ELECTRA GLIDE CLASSIC	1450	08		FD369	2	DF835	CW	FLV		FD369	DF836	W	FLV	
FLHTCU ULTRA CLASSIC ELECTRA GLIDE	1450	08	13	FD369	2	DF835	CW	FLV		FD369	DF836	W	FLV	
FLHTCU ULTRA CLASSIC ELECTRA GLIDE	1450	14		FD369	2	DF838	W	V		FD369				
FLHTK ELECTRA GLIDE ULTRA LTD	1450	10		FD369	2	DF835	CW	FLV		FD369	DF836	W	FLV	
FLHTP ELECTRA GLIDE STD. POLICE	1450	14		FD369	2	DF838	W	V		FD369				
FLHX/i STREET GLIDE	1450	06	07	FD235	2	DF680	W	FLV	FLW	FD235	DF681	W	FLV	
FLHX/i STREET GLIDE	1450	08	13	FD369	2	DF835	CW	FLV		FD369	DF836	W	FLV	
FLHX/i STREET GLIDE	1450	14		FD369	2	DF838	W	V		FD369				
FLTR ROAD GLIDE	1450	08		FD369	2	DF835	CW	FLV		FD369	DF836	W	FLV	
FLTRU ROAD GLIDE ULTRA	1450	11		FD369	2	DF835	CW	FLV		FD369	DF836	W	FLV	
FLTRX ROAD GLIDE CUSTOM	1450	10		FD369	2	DF835	CW	FLV		FD369	DF836	W	FLV	
FLHXS CVO STREET GLIDE SPECIAL	1745	18		FD369	2					FD369				
FLHXSE CVO STREET GLIDE	1745	18		FD369	2					FD369				
FLTRXS CVO ROAD GLIDE SPECIAL	1745	18		FD369	2					FD369				
FLTRXSE CVO ROAD GLIDE	1745	18		FD369	2					FD369				
SERIE VRSCA / B														
V-ROD (HAYES CALIPER)	1185	02	05	FD235	2	DF823	PW	PV		FD235	DF824	CW	FLV	
V-ROD (BREMBO CALIPER)	1185	06		FD369	2	DF821	PW	PV		FD369	DF822	CW	FLV	
VRSCAW V-ROD	1185	07	07	FD369	2	DF821	PW	PV		FD369	DF822	CW	FLV	
VRSCAW V-ROD	1185	08		FD369	2	DF835	CW	FLV		FD369	DF822	CW	FLV	
VRSCD NIGHT ROD	1185	05	08	FD369	2	DF821	PW	PV		FD369	DF822	CW	FLV	
VRSCDX NIGHT ROD SPECIAL	1185	07		FD369	2	DF821	PW	PV		FD369	DF822	CW	FLV	
VRSCF V-ROD MUSCLE	1185	08		FD369	2	DF821	PW	PV		FD369	DF822	CW	FLV	
VRSCR STREET ROD	1185	05	07	FD369	2	DF821	PW	PV		FD369	DF822	CW	FLV	
VRSCX V-ROD	1185	07	07	FD369	2	DF835	CW	FLV		FD369	DF822	CW	FLV	
VRSCX V-ROD 10th ANNIVERSARY	1185	12		FD369	2	DF821	PW	PV		FD369	DF822	CW	FLV	
SERIE XG														
XG 500 STREET	500	16		FD172	1	DF680	W	FLV	FLW	FD138				
XG 750 STREET	750	14	15	FD	1	DF835	CW	FLV		FD	DF836	W	FLV	
XG 750 STREET	750	16		FD172	1	DF680	W	FLV	FLW	FD138	DF724	W	FLV	
HERALD														
BRAT 125	125	19		FD533	1					FD165				
CAFÉ 125	125	19		FD533	1					FD165				
CLASSIC 125	125	19		FD533	1					FD165				
RAMBLER 125	125	19		FD533	1					FD165				
SCRAMBLER 125	125	19		FD533	1					FD165				
BRAT 250	250	19		FD533	1					FD165				
HIGHLAND														
950 V2 OUTBACK	950	00		FD138	2					FD165				
950 V2 MOTARD	950	00		FD138	2					FD165				
HM														
CRE BAJA	50	99	02	FD075	1	DF674	W	FLW		FD075	DF889	W		
CRE BAJA	50	03	08	FD162	1	DF674	W	FLW		FD065	DF889	W		
CRE BAJA	50	09		FD162	1					FD278	DF889	W		
CRE BAJA RR	50	09		FD411	1	DF674	W	FLW		FD278	DF889	W		
CRE SIX	50	99	02	FD162	1	DF674	W	FLW		FD075	DF889	W		
CRE SIX	50	03		FD162	1	DF674	W	FLW		FD065	DF889	W		
CRE SIX COMPETICION	50	09		FD411	1	DF674	W	FLW		FD278	DF889	W		
DERAPAGE	50	99	02	FD075	1	DF699	W	FLW		FD075	DF889	W		
DERAPAGE	50	03	08	FD162	1	DF699	W	FLW		FD065	DF889	W		
DERAPAGE	50	09		FD162	1	DF699	W	FLW		FD278	DF889	W		
DERAPAGE COMPETICION	50	09	10	FD411	1	DF699	W	FLW		FD278	DF889	W		
DERAPAGE COMPETICION	50	11		FD304	1	DF699	W	FLW		FD286	DF889	W		
DERAPAGE RR	50	09		FD162	1	DF699	W	FLW		FD278	DF889	W		
CR 125 MOTARD	125	03	06	FD164	1					FD278	DF069	W	WLL	
CRE 125 R	125	03		FD164	1	DF014	W	FLW	FLS	FD278	DF069	W	WLL	KG014
CRE F 125 X	125	08		FD162	1					FD278	DF010	W		
CRM 125 R	125	07		FD304	1	DF014	W	FLW		FD278	DF069	W	WLL	
CRM F 125 X	125	08		FD162	1					FD278	DF010	W		
DERAPAGE 2T	125	11		FD409	1	DF751	W	FLW		FD286				
DERAPAGE 2T COMPETICION	125	11		FD304	1	DF751	W	FLW		FD286				
DERAPAGE 4T	125	11		FD087	1	DF699	W	FLW		FD252	DF889	W		
DERAPAGE 4T COMPETICION	125	11		FD304	1	DF751	W	FLW		FD286				
CRF 150 R / R2	150	08		FD076	1	DF050	W			FD278	DF047	W		



APPLICATIONS

PADS

DISCS

SHOES

LINES

BRACKETS

KITS

CROSS REFERENCE

BRAND & MODEL · MARCA Y MODELO MARCA E MODELLO · MARQUE ET MODÈLE	C.C.	YEAR	FRONT					REAR				KITS 	
				N°		OE	UPGRADE 1	UPGRADE 2			OE		UPGRADE
continue HM													
EASY 230 F ENDURO	230	04	FD164	1						FD278	DF069	W	WLL
EASY 230 F MOTARD	230	04	FD164	1						FD278	DF069	W	WLL
EASY 230 F TRAIL	230	04	FD164	1						MF	-		
EASY 230 F TRAIL ID	230	04	FD164	1						FD278	DF069	W	WLL
CR 250 MOTARD	250	03	FD164	1						FD278	DF069	W	WLL
CRE 250 F	250	03	FD164	1	DF014	W	FLW	FLS	FD278	DF069	W	WLL	KG014
CRE 250 R	250	03	FD164	1	DF014	W	FLW	FLS	FD278	DF069	W	WLL	KG014
CRE 250 X	250	09	FD164	1	DF014	W	FLW	FLS	FD278	DF069	W	WLL	KG014
CRF 250 MOTARD	250	03	06	FD164	1					FD278	DF069	W	WLL
CRF 250 R	250	09	FD164	1	DF014	W	FLW	FLS	FD278	DF069	W	WLL	KG014
CRM 250 X	250	07	FD304	1	DF014	W	FLW		FD278	DF069	W	WLL	
CRE 300 X	300	09	FD164	1	DF014	W	FLW	FLS	FD278	DF069	W	WLL	KG014
CRE 450 F	450	03	FD164	1	DF014	W	FLW	FLS	FD278	DF069	W	WLL	KG014
CRE 450 R	450	09	FD164	1	DF014	W	FLW	FLS	FD278	DF069	W	WLL	KG014
CRE 450 X	450	09	FD164	1	DF014	W	FLW	FLS	FD278	DF069	W	WLL	KG014
CRF 450 MOTARD	450	03	FD164	1						FD278	DF069	W	WLL
CRF 450 R	450	09	FD164	1	DF014	W	FLW	FLS	FD278	DF069	W	WLL	KG014
CRM F 450 R	450	09	FD304	1	DF014	W	FLW		FD278	DF069	W	WLL	
CRM F 450 X	450	09	FD304	1	DF014	W	FLW		FD278	DF069	W	WLL	
CRE F 490 X	490	07	FD164	1	DF014	W	FLW	FLS	FD278	DF069	W	WLL	KG014
CRM F 490 X	490	07	FD304	1	DF014	W	FLW		FD278	DF069	W	WLL	
CRE 500 X	500	09	FD164	1	DF014	W	FLW	FLS	FD278	DF069	W	WLL	KG014
HONDA													
BALI 50 SJ	50	95	FD195	1	DF037	W	RW	FLS	MF002	-			
CB 50	50	95	FD266	1					MF003	-			
CRF 50 F	50	04	MF010		-				MF010	-			
DAX 50 ST	50	93	MF002		-				MF002	-			
DIO 50	50	91	93	FD149	1	DF018			MF001	-			
DIO ZX 50	50	94	FD149	1	DF018				MF001	-			
DREAM 50	50	01	FD145	1					FD144				
GP 50 DIO	50	92	FD149	1	DF018				MF001	-			
HSC 01-ZR	50	94	FD149	1	DF018				MF001	-			
MG 50 MAGNA	50	02	FD095	1					MF003	-			
NH LEAD 50	50	93	MF002		-				MF	-			
NPS 50 ZOOMER	50	01	MF001		-				MF001	-			
NS1 50 REPLICA	50	96	FD145	1	DF083	W			FD144				
NSC 50 AC	50	13	FD439	1	DF078	W			MF051	-			KG078
NSC 50 C	50	13	FD439	1	DF078	W			MF051	-			KG078
NSC 50 R	50	13	FD439	1	DF078	W			MF051	-			KG078
NSR 50	50	94	95	FD073	1				FD093				
PX WALLAROO	50	90	MF001		-				MF002	-			
SFX 50	50	95	FD153	1	DF038				MF002	-			
SGX 50 SKY	50	97	FD153	1	DF037	W	RW	FLS	MF008	-			
SH 50 SCOOPY	50	96	FD153	1	DF015	W			MF002	-			
SRX 50 SHADOW	50	97	FD144	1					MF002	-			
VISION 50	50	12	FD439	1	DF078	W			MF051	-			KG078
XR 50 MOTARD	50	05	FD145	1					FD144				
X8R-S	50	98	FD153	1					FD166	DF055	W		
CRF 70 F	70	04	MF001		-				MF001	-			
CRM 75 R	75	90	92	FD095	1				MF002	-			
CRM 75, R	75	93	FD074	1					MF002	-			
DAX ST 70	75	90	MF002		-				MF002	-			
NS1, REPLICA	75	92	FD145	1	DF083	W			FD144				
CR 80 R	80	90	96	FD095	1				FD093	DF047	W		
CR 80 R	80	97	02	FD076	1	DF050	W		FD093	DF047	W		
CRF 80 F	80	04	MF001		-				MF001	-			
CR 85 R	85	03	05	FD076	1	DF050	W		FD093	DF047	W		
CR 85 R	85	06	FD076	1	DF050	W			FD093	DF047	W		
CUB EZ 90	90	90	MF002		-				MF002	-			
NH 90 YUPI	90	91	FD144	1	DF037	W	RW	FLS	MF002	-			
SRX 90 SHADOW	90	97	FD144	1	DF037	W	RW	FLS	MF002	-			
BALI SJ 100 EX	100	95	FD195	1	DF037	W	RW	FLS	MF002	-			
CRF 100 F	100	04	MF001		-				MF001	-			
NSF 100	100	07	FD145	1					FD093				
SCV 100 LEAD	100	03	07	MF051		-			MF051	-			
XR 100 MOTARD	100	05	FD145	1					FD144				
SH 100 SCOOPY	100	96	FD153	1	DF015	W			MF002	-			
DIO 110	110	15	FD540	1					MF				
SCV 110 LEAD	110	08	FD063	1					MF051	-			
VISION 110 AC	110	11	18	FD439	1	DF078	W		MF051	-			KG078
VISION 110 WHB	110	11	18	FD439	1	DF078	W		MF051	-			KG078
VISION 110 CBS	110	19	FD540	1	DF078	W			MF051	-			



BRAND & MODEL · MARCA Y MODELO MARCA E MODELLO · MARQUE ET MODÈLE	C.C.	YEAR	FRONT					REAR				KITS		
			FD _{MF}	N°	DF	OE	UPGRADE 1	UPGRADE 2	FD _{MF}	DF	OE		UPGRADE	KG
continue HONDA														
@ 125	125	00	FD284	1	DF071	W	WS		MF051	-				KG071
ANF 125 INNOVA	125	03 06	FD298	1					MF	-				
ANF 125 INNOVA	125	07	FD298	1					MF	-				
CA 125 REBEL	125	95 98	FD187	1					MF005	-				
CA 125 REBEL	125	99	FD195	1					MF005	-				
CB 125 F	125	15	FD117	1					MF	-				
CB 125 R	125	18	FD499	1					FD103					
CBF 125	125	09	FD298	1					MF051	-				
CBR 125 R	125	04 10	FD298	1	DF031	W			FD259	DF048	W			
CBR 125 R	125	11	FD298	1	DF046	W			FD500	DF048	W			
CHA 125 SPACY	125	98	FD073	1	DF037	W	RW	FLS	MF	-				
CG 125	125	04	FD095	1					MF	-				
CITYFLY 125	125	99	FD195	1					MF	-				
CR 125 ENDURO	125	91	FD092	1					FD093	DF003	W			
CR 125 R	125	92 93	FD092	1	DF017	W			FD093	DF011	W			
CR 125 R	125	94 94	FD164	1	DF017	W			FD093	DF003	W			
CR 125 R	125	95 97	FD164	1	DF014	W	FLW	FLS	FD093	DF003	W		KG014	
CR 125 R	125	98 01	FD164	1	DF014	W	FLW	FLS	FD093	DF039	W		KG014	
CR 125 R	125	02 04	FD164	1	DF014	W	FLW	FLS	FD278	DF069	W	WLL	KG014	
CR 125 R	125	05 07	FD164	1	DF014	W	FLW	FLS	FD278	DF069	W	WLL	KG014	
CRM 125, R	125	90	FD074	1					FD012					
CUB	125	18	FD540	1					MF	-				
DYLAN 125	125	02	FD284	1	DF071	W	WS		MF051	-				KG071
FORZA 125	125	15	FD266	1	DF083	W			FD345	DF007	W			
MONKEY	125	18	FD298	1	DF933	W			FD259	DF911	W			
MSX 125	125	13 16	FD298	1	DF078	W			FD500	DF911	W			
MSX 125	125	17	FD298	1	DF933	W			FD500	DF911	W			
MTX 125 R2HI	125	91	FD074	1					MF002	-				
NSR 125 F (I)	125	90	FD074	1					FD190					
NSR 125 R (I)	125	90	FD074	1					FD190					
NX 125 (I)	125	90 92	FD074	1					MF003	-				
NX 125 (I) TRANSCITY	125	93	FD074	1					MF003	-				
PANTHEON 125	125	98 02	FD207	1	DF007	W			MF044	-				
PANTHEON 125	125	03	FD207	1	DF007	W			FD103	DF013	WA			
PCX 125	125	10 17	FD439	1	DF078	W			MF051	-				KG078
PCX 125	125	18	FD409	1	DF078	W			MF051	-				
PS 125i	125	06	FD284	1	DF071	W	WS		MF051	-				KG071
RS 125 R	125	90 92	FD266	1	DF012	CW			FD113	DF019	W			
RS 125 R	125	93	FD068	1	DF012	CW			FD113	DF019	W			
S WING 125 / ABS	125	07	FD344	1	DF006	W			FD345					
SH 125 MODE	125	13	FD439	1	DF078	W			MF051	-				KG078
SH 125 SCOOPY	125	01 04	FD284	1	DF071	W	WS		MF051	-				KG071
SH 125 i SCOOPY	125	05 08	FD284	1	DF071	W	WS		MF051	-				KG071
SH 125 i SCOOPY (D-D)	125	09 12	FD344	1	DF007	W	WS		FD345	DF007	W			KG007
SH 125 i SCOOPY (TAMBOR TRAS)	125	09 12	FD284	1	DF071	W	WS		MF051	-				KG071
SH 125 i SCOOPY ABS	125	13	FD344	1	DF007	W	WS		FD345	DF007	W			KG007
SH 125 i SCOOPY CBS	125	13	FD266	1	DF007	W	WS		FD345	DF007	W			
VT 125 SHADOW	125	00	FD145	1					MF005	-				
WAVE	125	12	FD	1					MF	-				
XL 125 P3 (I)	125	91 97	FD074	1					MF003	-				
XL 125 R	125	98 00	FD164	1	DF017	W			MF003	-				
XL 125 V VARADERO	125	01	FD145	1					FD259	DF048	W			
XR 125 L	125	03	FD164	1					MF003	-				
@ 150	150	00	FD284	1	DF071	W	WS		MF051	-				KG071
CBF 150	150	04	FD444	1					MF051	-				
CRF 150 F	150	03 06	FD164	1	DF017	W			MF003	-				
CRF 150 R	150	07	FD076	1	DF050	W			FD278	DF047	W			
DYLAN 150	150	02	FD284	1	DF071	W	WS		MF051	-				KG071
PANTHEON 150	150	98 02	FD207	1	DF007	W			MF044	-				
PANTHEON 150	150	03	FD207	1	DF007	W			FD103	DF013	WA			
PCX 150	150	13 17	FD439	1	DF078	W			MF051	-				KG078
PCX 150	150	18	FD409	1	DF078	W			MF051	-				
PS 150i	150	06	FD284	1	DF071	W	WS		MF051	-				KG071
S WING 150	150	07	FD344	1					FD345					
SH 150 SCOOPY	150	01 04	FD284	1	DF071	W	WS		MF051	-				KG071
SH 150 i SCOOPY	150	05	FD284	1	DF071	W	WS		MF051	-				KG071
SH 150 i SCOOPY (D-D)	150	09	FD344	1	DF007	W	WS		FD345	DF007	W			KG007
SH 150 i SCOOPY (TAMBOR TRAS)	150	09	FD284	1	DF071	W	WS		MF051	-				KG071
SH 150 i SCOOPY ABS	150	13	FD344	1	DF007	W	WS		FD345	DF007	W			KG007
SH 150 i SCOOPY CBS	150	13	FD266	1	DF007	W	WS		FD345	DF007	W			
FTR 223	223	00 02	FD284	1					MF	-				
CRF 230 F	230	04	FD164	1	DF017	W			MF003	-				





APPLICATIONS

PADS

DISCS

SHOES

LINES

BRACKETS

KITS

CROSS REFERENCE

BRAND & MODEL · MARCA Y MODELO MARCA E MODELLO · MARQUE ET MODÈLE	C.C.	YEAR	FRONT					REAR				KITS 		
				N°		OE	UPGRADE 1	UPGRADE 2			OE		UPGRADE	
continue HONDA														
CRF 230 L	230	08	FD164	1	DF017	W			FD278	DF048	W			
CRF 230 M	230	09	FD164	1	DF017	W			FD278	DF048	W			
XR 230	230	05	FD164	1					FD093					
CB 250	250	92	FD266	1					MF006	-				
CB 250 HORNET	250	96	FD148	1	DF027	CW			FD103	DF013	WA			
CB 250 TWO FIFTY	250	92	FD266	1	DF007	W			MF006	-				
CBF 250	250	04	FD145	1					MF051	-				
CBF 250 TWISTER	250	04	FD444	1					MF051	-				
CBR 250 R	250	11	FD266	1	DF079	CW			FD457	DF013	W			
CBR 250 R C-ABS	250	11	FD344	1	DF079	CW			FD457	DF013	WA			
CBR 250 RR ABS	250	17	FD140	1	DF092	CW			FD457	DF081	WA			
CMX REBEL 250 (NISSIN)	250	96	97	FD187	1				MF005	-				
CMX REBEL 250 (NISSIN)	250	98		FD187	1				MF005	-				
CMX REBEL 250 (GRIMECA)	250	00	07	FD195	1				MF005	-				
CN 250	250	93	FD054	1	DF020	W			MF037	-				
CN 250 HELIX	250	90	FD054	1	DF020	W			MF	-				
CN 250 SPAZIO	250	91	FD054	1	DF020	W			MF	-				
CR 250 ENDURO	250	91	FD092	1	DF017	W			FD093	DF048	W			
CR 250 R	250	90	91	FD092	1				FD093	DF003	W			
CR 250 R	250	92	94	FD164	1	DF017	W		FD093	DF003	W			
CR 250 R	250	95	96	FD164	1	DF014	W	FLW	FLS	FD093	DF003	W	KG014	
CR 250 R	250	97	01	FD164	1	DF014	W	FLW	FLS	FD093	DF039	W	KG014	
CR 250 R	250	02	04	FD164	1	DF014	W	FLW	FLS	FD278	DF069	W	WLL	KG014
CR 250 R	250	05	07	FD164	1	DF014	W	FLW	FLS	FD278	DF069	W	WLL	KG014
CRE 250	250	90	FD092	1					FD093					
CRF 250 L	250	13	FD298	1					FD500	DF048	W			
CRF 250 LD	250	13	FD409	1					FD500					
CRF 250 M	250	14	FD409	1					FD500					
CRF 250 R	250	04	07	FD164	1	DF014	W	FLW	FLS	FD278	DF069	W	WLL	KG014
CRF 250 R	250	08	14	FD164	1	DF014	W	FLW	FLS	FD278	DF069	W	WLL	KG014
CRF 250 R	250	15	18	FD164	1	DF082	W	WS	FLS	FD278	DF069	W	WLL	KG082
CRF 250 R	250	19		FD164	1	DF082	W	WS	FLS	FD278	DF069	W	WLL	KG082-2
CRF 250 RALLY	250	17	FD298	1	DF132	FLW			FD500	DF069	W	WLL		
CRF 250 X	250	04	FD164	1	DF014	W	FLW	FLS	FD278	DF069	W	WLL	KG014	
CRF 250 XR LD	250	13	FD164	1	DF014	W	FLW	FLS	FD278	DF069	W	WLL	KG014	
CRM 250 R	250	92	FD092	1	DF017	W			FD093					
FAZE 250	250	10	FD344	1	DF007	W			FD345	DF007	W		KG007	
FES 250 FORESIGHT	250	97	01	FD207	1	DF007	W		MF044	-				
FES 250 FORESIGHT DD	250	00		FD207	1	DF007	W		FD103	DF013	WA			
FES 250 FORZA, REFLEX	250	00	04	FD207	1	DF007	W		FD103	DF013	WA			
FES 250 FORZA EX	250	05		FD344	1	DF007	W		FD345	DF007	W		KG007	
FES 250 FORZA X / Z	250	05		FD344	1	DF007	W		FD345	DF007	W		KG007	
FES 250 JAZZ /ABS	250	00	04	FD207	1	DF007	W		FD103	DF013	WA			
FUSION	250	90	FD284	1					MF	-				
GB 250 CLUB MAN	250	95	FD082	1					MF	-				
NSF 250 R	250	12	FD331	1	DF012	CW			FD113	DF019	W			
NSR 250 R	250	93	FD068	2					FD163					
NX 250 DOMINATOR	250	97	FD164	1					MF	-				
PS 250	250	04	FD207	1	DF007	W			MF044	-				
RS 250 R	250	90	92	FD100	2	DF027	CW		FD113	DF019	W			
RS 250 R	250	93	96	FD068	2	DF027	CW		FD113	DF026				
TSR 250	250	98	FD168	2	DF027	CW			FD163	DF064	W			
VTR 250	250	98	08	FD140	1	DF065	CW		FD103	DF013	WA			
VTR 250 i	250	09		FD140	1	DF065	CW		FD103					
VTR 250 F	250	13		FD140	1	DF065	CW		FD103					
VTZ 250 XELVIS	250	97	FD266	1					FD103	DF013	WA			
V-TWIN MAGNA	250	97	FD266	1	DF022	W			MF	-				
XL 250 R	250	90	FD092	1	DF017	W			FD093	DF010	W			
XR 250 L, R	250	91	93	FD164	1	DF017	W		FD093	DF048	W			
XR 250 MOTARD	250	03	FD164	1					FD093	DF048	W			
XR 250 R	250	94	02	FD164	1	DF017	W		FD093	DF048	W			
XR 250 R	250	03	FD164	1	DF017	W			FD278	DF048	W			
CB 300 R	300	18	FD499	1	DF079	CW			FD103					
NSS 300 FORZA	300	13	18	FD344	1	DF083	W		FD345	DF007	W		KG007	
NSS 300 FORZA	300	19	FD266	1	DF083	W			FD345	DF007	W			
SH SCOOPY 300	300	07	10	FD344	1	DF083	W		FD345	DF083	W		KG083	
SH SCOOPY 300	300	11	15	FD344	1	DF083	W		FD345	DF083	W		KG083	
SH SCOOPY 300 ABS	300	07	14	FD344	1	DF083	W		FD345	DF083	W		KG083	
SH SCOOPY 300 i ABS	300	15	FD266	1	DF083	W			FD345	DF007	W			
CB 300 R	300	09	18	FD145	1				MF	-				
CB 300 R ABS	300	10	18	FD344	1	DF079	CW		FD134	DF007	W			
CB 300 R ABS	300	19	FD499	1					FD134	DF007	W			



BRAND & MODEL · MARCA Y MODELO MARCA E MODELLO · MARQUE ET MODÈLE	C.C.	YEAR	FRONT					REAR				KITS	
			FD _{MF}	N°	DF	OE	UPGRADE 1	UPGRADE 2	FD _{MF}	DF	OE		UPGRADE
continue HONDA													
CBR 300 R ABS	300	14	FD266	1	DF079	CW			FD457	DF013	WA		
XRE 300	300	09	FD164	1	DF004	W			FD093	DF048	W		
XRE 300 C-ABS	300	10	FD344	1	DF004	W			FD093	DF048	W		
CB 400 F	400	13	FD266	1	DF080				FD103	DF081	W		
CB 400 FOUR	400	97 00	FD266	1	DF059	CW			FD103	DF007	W		
CB 400 SUPER BOL D'OR	400	05 13	FD219	2	DF059	CW			FD134	DF007	W		
CB 400 SUPER BOL D'OR	400	14	FD219	2					FD134	DF007	W		
CB 400 SUPER FOUR	400	02 04	FD219	2	DF059	CW			FD267	DF007	W		
CB 400 SUPER FOUR	400	05 13	FD219	2	DF059	CW			FD134	DF007	W		
CB 400 SUPER FOUR	400	14	FD219	2					FD134	DF007	W		
CB 400 X	400	13	FD266	1	DF080				FD103	DF081	W		
CB 400 SS	400	01	FD266	1					MF	-			
CBR 400 RR	400	98	FD266	2	DF027	CW			FD134	DF013	WA		
FJS 400 SILVER WING	400	06	FD207	1	DF005	W			FD140	DF007	W		
NX 4 DOMINATOR	400	99 02	FD164	1	DF004	W			FD093	DF010	W		
NX 4 FALCON	400	03	FD164	1	DF083	W			FD093	DF048	W		
SILVER WING 400	400	02 08	FD207	1	DF083	W			FD140	DF007	W		
SILVER WING T 400	400	09	FD344	1	DF005	W			FD140	DF007	W		
VT 400 SHADOW	400	97 01	FD266	1					MF	-			
VT 400 SHADOW SLASHER	400	02	FD266	1					MF	-			
XR 400 MOTARD (DF017SM)	400	05	FD266	1	DF017	W			FD093	DF048	W		
XR 400 R	400	96	FD164	1	DF017	W			FD093	DF048	W		
CRF 450 F/R	450	01 03	FD164	1	DF014	W	FLW	FLS	FD278	DF039	W		KG014
CRF 450 F/R	450	04 07	FD164	1	DF014	W	FLW	FLS	FD278	DF069	W	WLL	KG014
CRF 450 F/R	450	08 14	FD164	1	DF014	W	FLW	FLS	FD278	DF069	W	WLL	KG014
CRF 450 L	450	19	FD164	1	DF082	W	WS	FLS	FD278	DF069	W	WLL	KG082-2
CRF 450 R	450	15 18	FD164	1	DF082	W	WS	FLS	FD278	DF069	W	WLL	KG082-2
CRF 450 R	450	19	FD164	1	DF082	W	WS	FLS	FD278	DF069	W	WLL	KG082-2
CRF 450 RALLY	450	13	FD164	1					FD278				
CRF 450 RX	450	18	FD164	1	DF082	W	WS	FLS	FD278	DF069	W	WLL	KG082
CRF 450 RX COUNTRY	450	17	FD164	1	DF082	W	WS	FLS	FD278	DF069	W	WLL	KG082
CRF 450 X	450	04	FD164	1	DF014	W	FLW	FLS	FD278	DF069	W	WLL	KG014
CRF 450 XR LD	450	13	FD164	1	DF014	W	FLW	FLS	FD278	DF069	W	WLL	KG014
CB 500	500	95 96	FD266	1	DF009	W			MF	-			
CB 500	500	97 97	FD172	1	DF009	W			FD165				
CB 500 F	500	13	FD266	1	DF080	W			FD103	DF081	W		
CB 500 F ABS	500	13	FD266	1	DF080	W			FD103	DF081	W		
CB 500 S	500	98	FD172	1	DF009	W			FD165				
CB 500 X	500	13 18	FD266	1	DF080	W			FD103	DF081	W		
CB 500 X	500	19	FD266	1	DF080	W			FD103	DF081	W		
CB 500 X ABS	500	13	FD266	1	DF080	W			FD103	DF081	W		
CB 500 X TRAVEL EDITION ABS	500	16	FD266	1	DF080	W			FD103	DF081	W		
CBF 500 ABS	500	04	FD344	1	DF009	W			FD134	DF072	W		
CBF 500 N	500	04	FD140	1	DF009	W			FD134	DF072	W		
CBR 500 R	500	13	FD266	1	DF080	W			FD103	DF081	W		
CBR 500 R ABS	500	13	FD266	1	DF080	W			FD103	DF081	W		
CMX 500 REBEL	500	18	FD266	1					FD103				
CR 500 ENDURO	500	91	FD092	1					FD093	DF003	W		
CR 500 R	500	90 92	FD092	1					FD093	DF003	W		
CR 500 R	500	92 94	FD164	1	DF017	W			FD093	DF003	W		
CR 500 R	500	95 00	FD164	1	DF014	W	FLW	FLS	FD093	DF003	W		KG014
599 (USA)	600	00 06	FD266	2	DF061	CW			FD134	DF013	WA		
599 (USA)	600	07	FD266	2	DF062	CW			FD363	DF072	W		
599 (USA) ABS	600	07	FD344	2	DF062	CW			FD134	DF072	W		
CB 600 HORNET	600	98 99	FD266	2	DF059	CW			FD134	DF013	WA		
CB 600 HORNET /S	600	00 06	FD266	2	DF061	CW			FD134	DF013	WA		
CB 600 HORNET	600	07	FD266	2	DF062	CW			FD363	DF072	W		
CB 600 HORNET ABS	600	07	FD344	2	DF062	CW			FD134	DF072	W		
CBF 600 /S	600	04 07	FD266	2	DF009	W			FD134	DF072	W		
CBF 600 /S	600	08	FD266	2	DF079	CW			FD134	DF072	W		
CBF 600 S ABS	600	08	FD344	2	DF079	CW			FD134	DF072	W		
CBR 600 F2	600	91 94	FD096	2	DF005	W			FD134	DF013	WA		
CBR 600 F3	600	95 98	FD266	2	DF027	CW			FD134	DF013	WA		
CBR 600 F4	600	99 00	FD219	2	DF676	CW			FD134	DF013	WA		
CBR 600 F4 i SPORT	600	01 10	FD219	2	DF063	CW			FD134	DF013	WA		
CBR 600 F	600	11	FD266	2	DF062	CW			FD363	DF072	W		
CBR 600 F ABS	600	11	FD344	2	DF062	CW			FD134	DF072	W		
CBR 600 RR	600	03 04	FD219	2	DF070	CW	CRW		FD134	DF013	WA		
CBR 600 RR	600	05 06	FD326	2	DF070	CW	CRW		FD134	DF013	WA		
CBR 600 RR	600	07	FD326	2	DF070	CW	CRW		FD363	DF013	WA		
CBR 600 RR	600	09	FD326	2	DF070	CW	CRW		FD363	DF013	WA		
CBR 600 RR C-ABS	600	09 12	FD326	2	DF070	CW	CRW		FD363	DF013	WA		





APPLICATIONS

PADS FD

DISCS DF

SHOES MF

LINES FK

BRACKETS SP

KITS KG

CROSS REFERENCE

BRAND & MODEL * MARCA Y MODELO MARCA E MODELLO * MARQUE ET MODÈLE	C.C.	YEAR	FRONT					REAR				KITS KG
			FD	N°	DF	OE	UPGRADE 1	UPGRADE 2	FD	DF	OE	
continue HONDA												
CBR 600 RR C-ABS	600	13	FD326	2	DF070	CW	CRW	FD363	DF013	WA		
FJS 600 SILVER WING	600	01	FD207	1	DF083	W		FD140	DF007	W		
FJS 600 SILVER WING ABS	600	03	FD207	1	DF005	W		FD140	DF007	W		
SW-T 600	600	11	FD344	1	DF005	W		FD140	DF007	W		
VT 600 SHADOW	600	06	FD266	1				MF	-			
VT 600 CD SHADOW VLX	600	94	FD266	1				MF	-			
XL 600 V TRANSALP	600	91	93	FD082	1	DF031	W	FD103	DF007	W		
XL 600 V TRANSALP	600	94	96	FD140	1	DF031	W	FD103	DF007	W		
XL 600 V TRANSALP	600	97	99	FD164	2	DF004	W	FD103	DF007	W		
XR 600 R	600	91	92	FD092	1	DF017	W	FD093	DF048	W		
XR 600 R	600	93		FD164	1	DF017	W	FD093	DF048	W		
CB 650 F ABS	650	14		FD266	2	DF080	W	FD103	DF081	W		
CB 650 R	650	19		FD499	2	DF136	CW	FD103	DF137	W		
CBR 650 F ABS	650	14		FD266	2	DF080	W	FD103	DF081	W		
CBR 650 R	650	19		FD499	2	DF136	CW	FD103	DF137	W		
FMX 650	650	05		FD266	1			FD103	DF010	W		
NTV 650 DEAUVILLE	650	98	01	FD172	2	DF009	W	FD103	DF040	W		
NTV 650 V DEAUVILLE	650	02		FD205	2	DF009	W	FD207	DF040	W		
NTV 650 REVERE	650	91		FD266	1	DF022	W	FD103				
NX 650 DOMINATOR	650	93	96	FD082	1	DF004	W	FD103	DF010	W		
NX 650 DOMINATOR	650	97		FD172	1	DF004	W	FD165	DF010	W		
SLR 650	650	96		FD172	1	DF031	W	FD165	DF010	W		
VIGOR 650	650	99		FD172	1	DF005	W	FD165	DF010	W		
XL 650 V TRANSALP	650	00		FD164	2	DF004	W	FD103	DF007	W		
XR 650 L	650	93		FD164	1	DF017	W	FD093	DF048	W		
XR 650 R	650	00		FD164	1	DF017	W	FD093	DF060	W		
DN - 01	680	08	09	FD344	2			FD140				
DN - 01 CONCEPT	680	10		FD344	2			FD140				
CTX 700	700	13		FD266	1	DF074	W	FD457	DF075	W		
CTX 700 ABS	700	13		FD266	1	DF074	W	FD457	DF075	W		
CTX 700 N	700	13		FD266	1	DF074	W	FD457	DF075	W		
CTX 700 N ABS	700	13		FD266	1	DF074	W	FD457	DF075	W		
INTEGRA	700	12		FD344	1	DF074	W	FD134	DF075	W		
NC 700 S	700	12		FD266	1	DF074	W	FD103	DF075	W		
NC 700 S ABS	700	12		FD344	1	DF074	W	FD134	DF075	W		
NC 700 X	700	12		FD266	1	DF074	W	FD103	DF075	W		
NC 700 X ABS	700	12		FD344	1	DF074	W	FD134	DF075	W		
NTV 700 V DEAUVILLE	700	06		FD344	2	DF009	W	FD207	DF040	W		
XL 700 V TRANSALP	700	08		FD164	2	DF004	W	FD103	DF007	W		
XL 700 V TRANSALP ABS	700	08		FD344	2	DF004	W	FD134	DF007	W		
CB 750 NIGHTHAWK	750	91		FD140	1			MF	-			
CB 750 SEVEN FIFTY	750	92		FD266	2	DF009	W	FD134	DF007	W		
INTEGRA	750	14		FD266	1	DF074	W	FD457	DF075	W		
INTEGRA S	750	14		FD266	1	DF074	W	FD457	DF075	W		
NC 750 S	750	14		FD266	1	DF074	W	FD457	DF075	W		
NC 750 S ABS	750	14		FD266	1	DF074	W	FD457	DF075	W		
NC 750 X	750	14		FD266	1	DF074	W	FD457	DF075	W		
NC 750 X ABS	750	14		FD266	1	DF074	W	FD457	DF075	W		
NM4-VULTUS	750	15		FD266	1	DF074	W	FD457	DF075	W		
NXR 750 AFRICA TWIN	750	91		FD082	2			FD103				
RVF 750 RR (RC45)	750	94		FD148	2	DF042	CW	FD110				
VF 750 C MAGNA	750	95		FD266	1	DF032	W	MF043	-			
VFR 750 F	750	90	93	FD266	2	DF009	W	FD140	DF029	W		
VFR 750 F	750	94	97	FD266	2	DF027	CW	FD140	DF029	W		
VT 750 C SHADOW	750	97		FD140	1	DF009	W	MF	-			
VT 750 C2 SHADOW BLACK	750	10		FD140	1	DF009	W	MF	-			
VT 750 C2 SHADOW ABS	750	10		FD344	1			FD267				
VT 750 DC BLACK WIDOW	750	02		FD140	1	DF009	W	MF	-			
VT 750 DC SPIRIT	750	07		FD140	1	DF009	W	MF	-			
X-ADV 750	750	17		FD499	2	DF097	CW	FD457	DF098	W		
XRV 750 AFRICA TWIN	750	90	93	FD096	2	DF021	W	FD103	DF049	W		
XRV 750 AFRICA TWIN	750	94		FD164	2	DF021	W	FD103	DF049	W		
CROSSRUNNER X	800	11	14	FD344	2	DF676	CW	FD443				
CROSSRUNNER X	800	15	16	FD326	2	DF070	CW	FD443				
CROSSRUNNER X	800	17		FD519	2	DF070	CW	FD443				
VFR 800	800	98	00	FD205	2	DF676	CW	FD207	DF029	W		
VFR 800 Vtec (INTERCEPTOR USA)	800	01	05	FD205	2	DF676	CW	FD207	DF029	W		
VFR 800	800	06		FD344	2	DF676	CW	FD207				
VFR 800 ABS	800	06	13	FD344	2	DF676	CW	FD207				
VFR 800 ABS	800	14	16	FD326	2	DF070	CW	CRW	FD443			
VFR 800 ABS	800	17		FD519	2	DF070	CW	FD443				
919 (USA)	900	01		FD148	2	DF063	CW	FD134	DF007	W		



BRAND & MODEL · MARCA Y MODELO MARCA E MODELLO · MARQUE ET MODÈLE	C.C.	YEAR	FRONT					REAR				KITS KG
			FD _{MF}	N°	DF	OE	UPGRADE 1	UPGRADE 2	FD _{MF}	DF	OE	
continue HONDA												
CB 900 SF HORNET	900	01	FD148	2	DF063	CW		FD134	DF007	W		
CBR 900 RR	900	92 92	FD148	2	DF676	CW		FD134	DF013	WA		
CBR 900 RR	900	93 97	FD148	2	DF027	CW		FD134	DF013	WA		
CBR 900 RR	900	98 99	FD219	2	DF041	CW		FD134	DF013	WA		
CBR 900 RR (929)	929	00 01	FD219	2	DF066	CW CRW		FD134	DF013	WA		
CBR 900 RR (954)	954	02	FD219	2	DF066	CW CRW		FD134	DF013	WA		
CB 1000 BIG ONE	1000	93	FD148	2	DF692	CW		FD134	DF040	W		
CB 1000 SF	1000	93	FD266	2	DF692	CW		FD140	DF040	W		
CB 1000 R	1000	08 17	FD326	2	DF070	CW CRW		FD443				
CB 1000 R ABS	1000	08 17	FD344	2	DF070	CW CRW		FD443				
CB 1000 R	1000	18	FD519	2	DF133	CW		FD512				
CB 1000 R NEO SPORTS CAFÉ	1000	18	FD519	2	DF133	CW		FD512				
CBF 1000	1000	06	FD266	2	DF079	CW		FD134	DF072	W		
CBF 1000 ABS	1000	06 10	FD344	2	DF079	CW		FD344	DF072	W		
CBF 1000 ABS	1000	11	FD344	2	DF079	CW		FD134	DF072	W		
CBR 1000 F DUAL	1000	93 99	FD155	2	DF009	W		FD155	DF028	W		
CBR 1000 RR FIREBLADE	1000	04 05	FD326	2	DF070	CW CRW		FD134	DF013	WA		
CBR 1000 RR FIREBLADE	1000	06 07	FD326	2	DF068	CW CRW		FD363	DF013	WA		
CBR 1000 RR FIREBLADE	1000	08	FD326	2	DF076	CW CRW		FD363	DF013	WA		
CBR 1000 RR FIREBLADE C-ABS	1000	09 16	FD326	2	DF076	CW CRW		FD363	DF013	WA		
CBR 1000 RR FIREBLADE	1000	17 19	FD519	2	DF089	CW		FD363	DF013	WA		
CBR 1000 RR R	1000	20	FD519	2	DF134	CW		FD220	DF135	W		
CBR 1000 RR FIREBLADE SP	1000	14 16	FD373	2	DF076	CW CRW		FD363	DF013	WA		
CBR 1000 RR FIREBLADE SP2	1000	17 19	FD373	2	DF091	CW CRW		FD363	DF013	WA		
CBR 1000 RR R SP	1000	20	FD373	2	DF134	CW		FD220	DF135	W		
CRF 1000 L AFRICA TWIN	1000	15	FD499	2	DF051	CW		FD134	DF052	W		
CRF 1000 L AFRICA TWIN ADVENTURE SPORTS	1000	18	FD499	2	DF051	CW		FD134	DF052	W		
RC 213 V	1000	15	FD373	2				FD220				
VARADERO	1000	99 02	FD205	2	DF676	CW		FD207	DF049	W		
VARADERO	1000	03	FD205	2	DF676	CW		FD207	DF028	W		
VARADERO ABS	1000	04	FD344	2	DF676	CW		FD207	DF028	W		
VTR 1000 F FIRESTORM	1000	97 99	FD148	2	DF027	CW		FD134	DF013	WA		
VTR 1000 F SUPER HAWK 996 (USA)	1000	97 99	FD148	2	DF027	CW		FD134	DF013	WA		
VTR 1000 SP-1	1000	00 01	FD219	2	DF068	CW CRW		FD134	DF013	WA		
VTR 1000 SP-1 KIT	1000	00 01	FD168	2	DF068	CW CRW		FD163				
VTR 1000 SP-2	1000	02	FD219	2	DF068	CW CRW		FD134	DF013	WA		
RVT 1000 RC 51 (USA)	1000	02	FD219	2	DF068	CW CRW		FD134	DF013	WA		
CB 1100	1100	10 12	FD219	2				FD134				
CB 1100	1100	13	FD344	2				FD134				
CB 1100 N	1100	17	FD519	2				FD134	DF028	W		
CB 1100 RS	1100	17	FD519	2				FD134	DF028	W		
CB 1100 EX	1100	15	FD219	2				FD134				
CB 1100 X 11 ELEVEN	1100	00	FD205	2	DF067	CW		FD207	DF028	W		
CBR 1100 XX SUP.BLACKBIRD	1100	97 99	FD205	2				FD207	DF028	W		
CBR 1100 XX i SUP.BLACKBIRD	1100	00	FD205	2	DF067	CW		FD207	DF028	W		
CRF 1100 L AFRICA TWIN	1100	20	FD499	2	DF051	CW		FD134	DF052	W		
CRF 1100 L AFRICA TWIN ADVENTURE SPORTS	1100	20	FD499	2	DF051	CW		FD134	DF052	W		
ST 1100 PAN-EUROPEAN	1100	91 95	FD266	2	DF022	W		FD140	DF054			
ST 1100 PAN EUROPEAN	1100	96 01	FD205	2	DF009	W		FD207	DF054			
ST 1100 PAN EUROPEAN CBS/ABS/TCS	1100	96 01	FD205	2	DF009	W		FD207	DF054			
VT 1100 C SHADOW	1100	94 94	FD140	1	DF036			MF043	-			
VT 1100 C2 ACE	1100	97	FD140	1	DF022	W		FD134	DF040	W		
VT 1100 C2 SHADOW ACE	1100	95 96	FD266	1	DF022	W		FD140	DF040	W		
VFR 1200 FA	1200	10 13	FD442	2	DF093	CW CRW		FD443	DF094	W		
VFR 1200 FA	1200	14	FD442	2	DF093	CW CRW		FD443	DF094	W		
VFR 1200 FDA DCT	1200	10 13	FD442	2	DF093	CW CRW		FD512	DF094	W		
VFR 1200 FDA DCT	1200	14	FD442	2	DF093	CW CRW		FD512	DF094	W		
VFR 1200 X CROSSTOURER	1200	12	FD344	2	DF140	W		FD512	DF094	W		
VFR 1200 X CROSSTOURER DCT	1200	12	FD344	2	DF140	W		FD512	DF094	W		
VFR 1200 X CROSSTOURER TRAV. ED.	1200	16	FD344	2	DF140	W		FD512	DF094	W		
VFR 1200 X CROSSTOURER TRAV. ED. DCT	1200	16	FD344	2	DF140	W		FD512	DF094	W		
VT 1200 MAGNA	1200	95	FD266	2				FD140				
CB 1300	1300	92 97	FD148	2				FD134				
CB 1300	1300	98 00	FD193	2				FD267				
CB 1300	1300	01 02	FD219	2	DF067	CW		FD267				
CB 1300	1300	03 04	FD219	2	DF070	CW CRW		FD134	DF028	W		
CB 1300 F	1300	10	FD344	2	DF070	CW CRW		FD134	DF028	W		
CB 1300 S	1300	05 09	FD219	2	DF070	CW CRW		FD134	DF028	W		
CB 1300 S	1300	10	FD344	2				FD134				
CB 1300 SUPER BOL D'OR / ABS	1300	05	FD219	2	DF070	CW CRW		FD134	DF028	W		
CB 1300 SUPER FOUR / ABS	1300	05	FD219	2	DF070	CW CRW		FD134	DF028	W		
CTX 1300 C ABS	1300	14	FD344	2	DF070	CW CRW		FD207				





APPLICATIONS

PADS FD

DISCS DF

SHOES MF

LINES FK

BRACKETS SP

KITS KG

CROSS REFERENCE

BRAND & MODEL * MARCA Y MODELO MARCA E MODELLO * MARQUE ET MODÈLE	C.C.	YEAR	FRONT					REAR					KITS
			FD	N°	DF	OE	UPGRADE 1	UPGRADE 2	FD	DF	OE	UPGRADE	
continue HONDA													
ST 1300 PAN-EUROPEAN	1300	02	07	FD205	2	DF909	CW			FD207	DF910	W	
ST 1300 PAN-EUROPEAN ABS	1300	08		FD344	2	DF909	CW			FD207	DF910	W	
VT 1300 CS	1300	10		FD140	1					FD134			
VT 1300 CS ABS	1300	10		FD344	1					FD205			
VT 1300 CX	1300	10		FD140	1					FD134			
VT 1300 CX ABS	1300	10		FD344	1					FD205			
VTX 1300 S/C RETRO	1300	03		FD266	1					FD134			
X-4 LOW DOWN	1300	00		FD148	2					FD267	DF040	W	
F6C 1500 VALKYRIA	1500	97		FD266	2	DF676	CW			FD140	DF054		
GL 1500 SE GOLD WING	1500	91		FD082	2	DF053				FD054	DF054		
GL 1800 GOLD WING	1800	01	05	FD205	2	DF676	CW			FD207			
GL 1800 GOLD WING	1800	06		FD205	2	DF676	CW			FD207			
GL 1800 GOLD WING 12YM	1800	12		FD344	2	DF676	CW			FD344			
GL 1800 GOLD WING F6B	1800	13		FD344	2	DF676	CW			FD344			
GL 1800 GOLD WING F6 40th	1800	15		FD344	2	DF676	CW			FD344			
NRX 1800 VALKYRIE RUNE	1800	03		FD205	2					FD207			
VTX 1800 C	1800	01		FD205	2	DF063	CW			FD207	DF054		
VTX 1800 RETRO	1800	03		FD205	2	DF063	CW			FD207	DF054		
RS 500 RACING CALIPER				FD088									
HONDA 4 Wheels													
TRX 90	90	93	06	MF002		-				MF	-		
TRX 90 EX	90	07	08	MF002		-				MF	-		
TRX 90 X9	90	09		MF002		-				MF	-		
TRX 200	200	90	91	MF		-				MF022	-		
TRX 200 D T.2	200	91	93	MF		-				MF022	-		
TRX 250 EX	250	01		FD076	2	DF712	W			MF	-		
TRX 250 R	250	90		FD076	2	DF712	W			FD076	DF713	W	
TRX 250 RECON	250	03	05	FD076	2					MF006	-		
TRX 250 X9	250	09		FD076	2	DF712	W			MF006	-		
TRX 300 EX	300	93	08	FD076	2	DF712	W			FD076	DF713	W	
TRX 300 X9	300	09		FD076	2	DF712	W			FD076			
TRX 400 EX	400	99	08	FD076	2	DF712	W			FD076	DF013	W	
TRX 400 X9	400	09	08	FD076	2	DF712	W			FD076	DF013	W	
TRX 420 FOURTRAX RANCHER	420	07		FD076	2					MF044	-		
TRX 420 FOURTRAX RANCHER AT	420	09		FD076	2					FD323			
TRX 450 R	450	04	09	FD164	2	DF712	W			FD323	DF895	W	
TRX 500 TM/FM/FA/FGA/R	500	05	11	FD	2					MF043	-		
TRX 500 FAC/FEC/FMC/FPAC 2/4 WD	500	12		FD076	2						-		
TRX 650 RINCON	650	03	05	MF		-				FD323			
TRX 680 RINCON	680	06		MF		-				FD323			
TRX 700 XX	700	08		FD164	2	DF712	W			FD			
HONDA RED MOTO													
CRF 150 R	150	07		FD076	1	DF050	W			FD278	DF047	W	
CRF 250 R	250	15	18	FD164	1	DF082	W	WS	FLS	FD278	DF069	W	WLL
CRF 250 R	250	19		FD164	1	DF082	W	WS	FLS	FD278	DF069	W	WLL
CRF 250 R ENDURO	250	15		FD164	1	DF082	W	WS	FLS	FD278	DF069	W	WLL
CRF 250 X	250	14		FD164	1	DF014	W	WS	FLS	FD278	DF069	W	WLL
4 RIDE	260	16		FD460	1	DF086	W			FD224	DF087	W	
COTA 4RT	260	15		FD460	1	DF086	W			FD224	DF809	W	
COTA 4RT RACE REPLICA	260	15		FD460	1	DF086	W			FD224	DF809	W	
300 RR	300	15		FD460	1	DF086	W			FD224	DF809	W	
CRF 300 R ENDURO	300	15		FD164	1	DF082	W	WS	FLS	FD278	DF069	W	WLL
CRF 300 X	300	14		FD164	1	DF014	W	WS	FLS	FD278	DF069	W	WLL
CRF 450 R	450	15	18	FD164	1	DF082	W	WS	FLS	FD278	DF069	W	WLL
CRF 450 R	450	19		FD164	1	DF082	W	WS	FLS	FD278	DF069	W	WLL
CRF 450 RS	450	15		FD164	1	DF082	W	WS	FLS	FD278	DF069	W	WLL
CRF 450 RS	450	17		FD373	1					FD278	DF069	W	WLL
CRF 450 RX	450	15		FD164	1	DF082	W	WS	FLS	FD278	DF069	W	WLL
CRF 450 RX	450	17		FD373	1					FD278	DF069	W	WLL
CRF 450 RX COUNTRY	450	15		FD164	1	DF082	W	WS	FLS	FD278	DF069	W	WLL
CRF 450 RXC	450	17		FD373	1					FD278	DF069	W	WLL
HOREX													
VR6	1250	12		FD176	2					FD220			
HUSABERG													
125 TE	125	11		FD138	1	DF606	W	FLW	FLS	FD291	DF607	W	WLL
250 FE	250	13		FD138	1	DF606	W	FLW	FLS	FD291	DF607	W	WLL
250 TE	250	11		FD138	1	DF606	W	FLW	FLS	FD291	DF607	W	WLL
300 TE	300	11		FD138	1	DF606	W	FLW	FLS	FD291	DF607	W	WLL
350 FC	350	95	99	FD138	1	DF626	FLW			FD165			
350 FE	350	95	99	FD138	1	DF626	FLW			FD165			
350 FE	350	13		FD138	1	DF606	W	FLW	FLS	FD291	DF607	W	WLL
350 MC	350	91	92	FD089	1					FD075			



BRAND & MODEL · MARCA Y MODELO MARCA E MODELLO · MARQUE ET MODÈLE	C.C.	YEAR	FRONT					REAR				KITS		
			FD	N°	DF	OE	UPGRADE 1	UPGRADE 2	FD	DF	OE		UPGRADE	KG
continue HUSABERG														
350 MC	350	94	FD089	1						FD165				
390 FE	390	10	FD138	1	DF606	W	FLW	FLS		FD291	DF607	W	WLL	KG606
400 FE	400	00	FD138	1	DF606	W	FLW	FLS		FD165	DF607	W	WLL	
450 FC/FE	450	04	FD138	1	DF606	W	FLW	FLS		FD165	DF607	W	WLL	
450 FE	450	12	FD138	1	DF606	W	FLW	FLS		FD291	DF607	W	WLL	KG606
450 FS	450	04	FD068	1						FD165	DF607	W	WLL	
450 FSE	450	05	FD	1						FD165	DF607	W	WLL	
450 FX	450	10	FD138	1	DF606	W	FLW	FLS		FD291	DF607	W	WLL	KG606
500 CROSS	500	93	FD138	1						FD075				
500 MC	500	91	FD089	1						FD075				
501 FC	501	95	FD138	1	DF626	FLW				FD165				
501 FE	501	95	FD138	1	DF626	FLW				FD165				
501 FE	501	13	FD138	1	DF606	W	FLW	FLS		FD291	DF607	W	WLL	KG606
501 MC	501	94	FD089	1						FD165				
501 MC ENDURO	501	91	FD089	1						FD075				
550 FC/FE	550	04	FD138	1	DF606	W	FLW	FLS		FD165	DF607	W	WLL	
570 FE	570	09	FD138	1	DF606	W	FLW	FLS		FD291	DF607	W	WLL	KG606
570 FS	570	10	FD304	1	DF672	FLW				FD291	DF607	W	WLL	
600 FC	600	95	FD138	1	DF626	FLW				FD165				
600 FE	600	95	FD138	1	DF626	FLW				FD165				
650 FC/FE	650	04	FD138	1	DF606	W	FLW	FLS		FD165	DF607	W	WLL	
650 FS	650	03	FD068	1						FD165	DF607	W	WLL	
650 FS	650	04	FD	1						FD165				
HUSABERG 4 Wheels														
EF 400 /E	400	99	FD165	2						FD075				
EF 501 /E	500	99	FD165	2						FD075				
EF 600 /E	600	99	FD165	2						FD075				
HUSQVARNA														
EE 5	EL	20	FD230	1						FD230				
E-go	EL	12	FD138	1						FD441				
CR 50	50	11	FD230	1						FD230				
50 CR SENIOR PRO	50	05	FD224	1						FD230				
SM 50	50	11	FD230	1						FD230				
65 CR	65	11	FD265	1	DF872	W				FD441	DF873	W		
85 TC 17/14	85	14	FD458	1	DF777	W				FD441	DF797	W		
85 TC 19/16	85	14	FD458	1	DF794	W				FD441	DF797	W		KG794
100 TE	100	05	FD224	1						FD230				
125 CR	125	91	FD089	1						FD075	DF638	W		
125 CR	125	94	FD138	1	DF626	FLW				FD165	DF638	W		
125 CR	125	93	FD086	1	DF626	FLW				FD075	DF638	W		
125 CR	125	00	FD138	1	DF635	FLW	FLS	FRS		FD165	DF885	W	PW	
125 CR	125	04	FD138	1	DF635	FLW	FLS	FRS		FD291	DF885	W	PW	
125 CR	125	05	FD138	1	DF635	FLW	FLS	FRS		FD291	DF670	W	PW	
125 CR, WR	125	93	FD086	1	DF626	FLW				FD075	DF638	W		
125 SM S	125	00	FD138	1	DF635	FLW	FLS	FRS		FD165	DF885	W	PW	
125 SM S 4T	125	11	FD138	1	DF635	FLW	FLS	FRS		FD165	DF885	W	PW	
125 TC	125	14	FD138	1	DF606	W	FLW	FLS		FD291	DF607	W	WLL	KG606
125 TE 4T	125	11	FD138	1	DF635	FLW	FLS	FRS		FD165	DF885	W	PW	
125 TE	125	14	FD138	1	DF606	W	FLW	FLS		FD291	DF607	W	WLL	KG606
125 TX	125	18	FD138	1	DF606	W	FLW	FLS		FD291	DF607	W	WLL	KG606
125 WR	125	91	FD089	1						FD075	DF638	W		
125 WR	125	94	FD138	1	DF626	FLW				FD165	DF638	W		
125 WR	125	93	FD086	1	DF626	FLW				FD075	DF638	W		
125 WR	125	00	FD138	1	DF635	FLW	FLS	FRS		FD165	DF885	W	PW	
125 WR	125	06	FD138	1	DF635	FLW	FLS	FRS		FD291	DF670	W	PW	
125 WRE	125	94	FD138	1	DF626	FLW				FD165	DF638	W		
125 WRE	125	00	FD138	1	DF635	FLW	FLS	FRS		FD165	DF885	W	PW	
125 WXE	125	07	FD133	1	DF635	FLW	FLS	FRS		FD093				
250 CR	250	91	FD089	1						FD075	DF638	W		
250 CR	250	94	FD138	1	DF626	FLW				FD165	DF638	W		
250 CR	250	00	FD138	1	DF635	FLW	FLS	FRS		FD165	DF885	W	PW	
250 CR	250	04	FD138	1	DF635	FLW	FLS	FRS		FD291	DF885	W	PW	
250 CR	250	05	FD138	1	DF635	FLW	FLS	FRS		FD291	DF670	W	PW	
250 CR, WR	250	93	FD086	1	DF626	FLW				FD075	DF638	W		
250 FC	250	14	FD138	1	DF606	W	FLW	FLS		FD291	DF607	W	WLL	KG606
250 FE	250	14	FD138	1	DF606	W	FLW	FLS		FD291	DF607	W	WLL	KG606
250 TC	250	04	FD138	1	DF635	FLW	FLS	FRS		FD291	DF885	W	PW	
250 TC	250	05	FD138	1	DF635	FLW	FLS	FRS		FD291	DF670	W	PW	
250 TC	250	14	FD138	1	DF606	W	FLW	FLS		FD291	DF607	W	WLL	KG606
250 TE	250	05	FD138	1	DF635	FLW	FLS	FRS		FD291	DF885	W	PW	
250 TE R	250	13	FD138	1	DF635	FLW	FLS	FRS		FD291	DF885	W	PW	
250 TE	250	14	FD138	1	DF606	W	FLW	FLS		FD291	DF607	W	WLL	KG606

APPLICATIONS

PADS FD

DISCS DF

SHOES MF

LINES FK

BRACKETS SP

KITS KG

CROSS REFERENCE





APPLICATIONS

PADS

DISCS

SHOES

LINES

BRACKETS

KITS

CROSS REFERENCE

BRAND & MODEL · MARCA Y MODELO MARCA E MODELLO · MARQUE ET MODÈLE	C.C.	YEAR	FRONT					REAR				KITS 		
				N°		OE	UPGRADE 1	UPGRADE 2			OE		UPGRADE	
continue HUSQVARNA														
250 i TE	250	17	FD138	1	DF606	W	FLW	FLS	FD291	DF607	W	WLL	KG606	
250 WR	250	91	FD089	1					FD075	DF638	W			
250 WR	250	94	99	FD138	1	DF626	FLW		FD165	DF638	W			
250 WR	250	00		FD138	1	DF635	FLW	FLS	FRS	FD165	DF885	W	PW	
260 WR	260	91		FD089	1				FD075	DF638	W			
300 TE	300	14	16	FD138	1	DF606	W	FLW	FLS	FD291	DF607	W	WLL	KG606
300 i TE	300	17		FD138	1	DF606	W	FLW	FLS	FD291	DF607	W	WLL	KG606
300 WR	300	09		FD138	1	DF635	FLW	FLS	FRS	FD291	DF885	W	PW	
310 TE	310	09		FD138	1	DF635	FLW	FLS	FRS	FD291	DF670	W	PW	
310 TE R	310	13		FD138	1	DF635	FLW	FLS	FRS	FD291	DF670	W	PW	
350 FC	350	14		FD138	1	DF606	W	FLW	FLS	FD291	DF607	W	WLL	KG606
350 FE	350	14		FD138	1	DF606	W	FLW	FLS	FD291	DF607	W	WLL	KG606
350 TE	350	94	99	FD138	1	DF626	FLW			FD165	DF638	W		
350 TE 4T	350	91	94	FD089	1	DF626	FLW			FD075	DF638	W		
360 CR	360	92	94	FD089	1	DF626	FLW			FD075	DF638	W		
360 CR	360	94	99	FD138	1	DF626	FLW			FD165	DF638	W		
360 WR	360	92	94	FD086	1	DF626	FLW			FD076	DF638	W		
360 WR	360	94	99	FD138	1	DF626	FLW			FD165	DF638	W		
360 WR	360	00		FD138	1	DF635	FLW	FLS	FRS	FD165	DF885	W	PW	
401 SVARTPILEN	375	17	18	FD450	1					FD165	DF790	W		
401 VITPILEN	375	17	18	FD450	1					FD165	DF790	W		
401 SVARTPILEN	375	19		FD450	1	DF940	CW			FD165	DF790	W		
401 VITPILEN	375	19		FD450	1	DF940	CW			FD165	DF790	W		
TE 410	410	94	99	FD138	1	DF626	FLW			FD165	DF638	W		
TE 410/E	410	00		FD138	1	DF635	FLW	FLS	FRS	FD165	DF885	W	PW	
449 TE	449	11		FD138	1	DF635	FLW	FLS	FRS	FD291	DF670	W	PW	
450 FE	450	14		FD138	1	DF606	W	FLW	FLS	FD291	DF607	W	WLL	KG606
450 FC	450	14		FD138	1	DF606	W	FLW	FLS	FD291	DF607	W	WLL	KG606
450 FS	450	17		FD373	1	DF606	CEW			FD291	DF885	W	PW	
450 SM S	450	01	04	FD176	1	DF645	CW			FD165	DF885	W	PW	
450 SM R	450	01	04	FD068	1	DF645	CW			FD165	DF885	W	PW	
450 SM R	450	05	05	FD262	1	DF645	CW			FD165	DF885	W	PW	
450 SM / RR	450	06		FD262	1	DF645	CW			FD291	DF885	W	PW	
450 TC	450	05		FD138	1	DF635	FLW	FLS	FRS	FD291	DF670	W	PW	
450 TE	450	05		FD138	1	DF635	FLW	FLS	FRS	FD291	DF670	W	PW	
SMR 449	450	11		FD262	1					FD291				
TC 449	450	11		FD138	1	DF635	FLW	FLS	FRS	FD291	DF885	W	PW	
TE 449	450	11		FD138	1	DF635	FLW	FLS	FRS	FD291	DF885	W	PW	
501 FE	501	14		FD138	1	DF606	W	FLW	FLS	FD291	DF607	W	WLL	KG606
510 TC	510	04	04	FD138	1	DF635	FLW	FLS	FRS	FD291	DF885	W	PW	
510 TC	510	05		FD138	1	DF635	FLW	FLS	FRS	FD291	DF670	W	PW	
510 TE	510	90	94	FD089	1	DF626	FLW			FD075	DF638	W		
510 TE	510	95	99	FD138	1	DF626	FLW			FD165	DF638	W		
510 TE	510	00	04	FD138	1	DF635	FLW	FLS	FRS	FD165	DF885	W	PW	
510 TE	510	05		FD138	1	DF635	FLW	FLS	FRS	FD291	DF670	W	PW	
510 SM R	510	05	05	FD262	1	DF645	CW			FD165	DF885	W	PW	
510 SM R	510	06		FD262	1	DF645	CW			FD291	DF885	W	PW	
SMR 511	511	11		FD262	1					FD291				
TE 511	511	11		FD138	1	DF635	FLW	FLS	FRS	FD291	DF885	W	PW	
530 RR	530	09		FD176	1	DF645	CW			FD291				
570 SM S	570	01		FD176	1	DF645	CW			FD165	DF885	W	PW	
570 SM R	570	01		FD068	1	DF645	CW			FD165	DF885	W	PW	
570 TE	570	00		FD138	1	DF635	FLW	FLS	FRS	FD165	DF885	W	PW	
NOX	600	01		FD068	1	DF645	CW			FD165	DF885	W	PW	
610LT	610	00		FD176	1	DF645	CW			FD165	DF885	W	PW	
610 SM S	610	00	04	FD176	1	DF645	CW			FD165	DF885	W	PW	
610 SM R	610	00	04	FD068	1	DF645	CW			FD165	DF885	W	PW	
610 SM R	610	05	05	FD262	1	DF645	CW			FD165	DF885	W	PW	
610 SM R	610	06		FD262	1	DF645	CW			FD165	DF885	W	PW	
610 SM ie	610	07		FD262	1	DF645	CW			FD165	DF885	W	PW	
610 TC	610	94	99	FD138	1	DF626	FLW			FD165	DF638	W		
610 TC	610	00		FD138	1	DF635	FLW	FLS	FRS	FD165	DF885	W	PW	
610 TC, TE 4T	610	91	94	FD089	1	DF626	FLW			FD075	DF638	W		
610 TE	610	92	94	FD086	1	DF626	FLW			FD095	DF638	W		
610 TE	610	94	99	FD138	1	DF626	FLW			FD165	DF638	W		
610 TE	610	00		FD138	1	DF635	FLW	FLS	FRS	FD165	DF885	W	PW	
630 SM	630	10		FD262	1					FD165				
630 SMR	630	06		FD068	1	DF645	CW			FD291	DF885	W	PW	
630 SMS	630	11		FD262	1					FD165				
630 TE	630	10		FD138	1	DF635	FLW	FLS	FRS	FD165	DF885	W	PW	
MOAB	650	12		FD172	1					FD165				
STR 650 CRC	650	07		FD262	1	DF645	CW			FD291	DF885	W	PW	



BRAND & MODEL · MARCA Y MODELO MARCA E MODELLO · MARQUE ET MODÈLE	C.C.	YEAR	FRONT					REAR				KITS KG
			FD _{MF}	N°	DF	OE	UPGRADE 1	UPGRADE 2	FD _{MF}	DF	OE	
continue HUSQVARNA												
TR 650 STRADA	650	12	FD172	1	DF663	FLW			FD165	DF703	W	
TR 650 TERRA	650	12	FD172	1	DF663	FLW			FD165	DF703	W	
701 ENDURO ABS	701	16	FD172	1	DF770	FLW			FD165	DF847	FLW	
701 SUPERMOTO	701	15	FD262	1					FD165			
701 SVARTPILEN	701	18	19	FD176	1	DF787	CW		FD165	DF798	W	
701 SVARTPILEN	701	20		FD176	1	DF846	FLW		FD165	DF782	FLW	
701 VITPILEN	701	18	19	FD176	1	DF787	CW		FD165	DF798	W	
701 VITPILEN	701	20		FD176	1	DF846	FLW		FD165	DF782	FLW	
NUDA 900	900	12		FD176	2	DF707	W		FD165	DF763	W	
NUDA 900 R	900	11		FD373	2	DF707	W		FD165	DF763	W	
HYOSUNG												
GEN 2.0	EL	10		FD094	1				MF	-		
GEN 4.0	EL	10		FD145	1				FD145			
FAST SF 50	50	00		FD094	1				MF	-		
SF 50 RALLY	50	03		FD094	1				MF	-		
SENSE 50	50	98		FD094	1				MF	-		
SUPER CAB PLUS 50	50	98		FD094	1				MF	-		
EZ 100	100	98		FD094	1				MF	-		
COMET GT 125	125	02		FD544	1				FD544			
COMET GT 125 R	125	06		FD544	1				FD544			
EXIV 125	125	12		FD176	1				FD094			
GT 125 Pi	125	13		FD544	1				FD544			
GV 125	125	00	04	FD086	1				MF	-		
GV 125 AQUILA	125	05		FD544	1				MF	-		
EXCEED 125	125	03		FD153	1				MF	-		
GRAND PRIX 125	125	98		FD171	1				MF	-		
KARION	125	02		FD544	1				MF	-		
XRX 125	125	00		FD544	1				MF	-		
EXCEED 150	150	03		FD153	1				FD117			
AQUILA 250 V-TWIN	250	02		FD544	1				MF	-		
COMET GT 250	250	02		FD544	1				FD544			
COMET GT 250 R	250	06		FD544	2				FD544			
GD 250 N	250	14		FD176	1				FD153			
GD 250 R	250	14		FD176	1				FD153			
GT 250 Pi	250	13		FD544	1				FD544			
GV 250	250	04		FD544	1				MF	-		
XRX 400	400	05		FD544	1				FD093			
GT 650 / S / R	650	05		FD544	2				FD544			
GT 650 i	650	09	11	FD176	2				FD544			
GT 650 Pi	650	13		FD176	2				FD544			
GT 650 Ri	650	09		FD176	2				FD544			
GT 650 X	650	07		FD544	2				FD544			
GV 650	650	06		FD544	2				FD544			
GV 650 AQUILIA	650	04		FD544	2				FD295			
AQUILA 700 GV i	700	10		FD176	1				FD063			
ST 7	700	10		FD176	1				FD063			
GV 1000	1000	04		FD544	2				FD295			
HYOSUNG 4 Wheels												
TE 400	400	05		FD095	2				FD095			
TE 450	450	06		FD095	2				FD095			
INDIAN MOTORCYCLE												
SCOUT SIXTY	999	16		FD068	1	DF518	W		FD336	DF518	W	
SCOUT	1130	15		FD068	1	DF518	W		FD336	DF518	W	
SCOUT BOBBER	1130	18		FD172	1	DF518	W		FD165	DF518	W	
SCOUT FTR	1130	18		FD373	1				FD165			
SCOUT SIXTY	1130	18		FD172	1	DF518	W		FD165	DF518	W	
CHALLENGER DARK HORSE	1200	20		FD475	2				FD			
FTR 1200	1200	19		FD475	2				FD220			
FTR 1200 S	1200	19		FD475	2				FD220			
CHIEF BLACKHAWK	1720	11		FD068	2	DF472	FLW	FLV	FD013	DF472	FLW	FLV
CHIEF BLACKHAWK DARK	1720	11		FD068	2	DF472	FLW	FLV	FD013	DF472	FLW	FLV
CHIEF BOMBER	1720	09		FD068	2	DF472	FLW	FLV	FD013	DF472	FLW	FLV
CHIEF CLASSIC	1720	09	13	FD068	2	DF472	FLW	FLV	FD013	DF472	FLW	FLV
CHIEF CLASSIC	1720	14		FD331	2	DF472	FLW	FLV	FD140	DF472	FLW	FLV
CHIEF DARK HORSE	1720	09	15	FD068	2	DF472	FLW	FLV	FD013	DF472	FLW	FLV
CHIEF DELUXE	1720	09		FD068	2	DF472	FLW	FLV	FD013	DF472	FLW	FLV
CHIEF ROADMASTER	1720	09		FD068	2	DF472	FLW	FLV	FD013	DF472	FLW	FLV
CHIEF STANDARD	1720	09		FD068	2	DF472	FLW	FLV	FD013	DF472	FLW	FLV
CHIEF VINTAGE	1720	09	13	FD068	2	DF472	FLW	FLV	FD013	DF472	FLW	FLV
CHIEF DARK HORSE	1811	16		FD331	2	DF472	FLW	FLV	FD140	DF472	FLW	FLV
CHIEF VINTAGE	1811	14		FD331	2	DF472	FLW	FLV	FD140	DF472	FLW	FLV
CHIEFTAIN	1811	14		FD331	2	DF472	FLW	FLV	FD140	DF472	FLW	FLV



APPLICATIONS
 PADS FD
 DISCS DF
 SHOES MF
 LINES FK
 BRACKETS SP
 KITS KG
 CROSS REFERENCE



APPLICATIONS

PADS FD

DISCS DF

SHOES MF

LINES FK

BRACKETS SP

KITS KG

CROSS REFERENCE

BRAND & MODEL • MARCA Y MODELO MARCA E MODELLO • MARQUE ET MODÉLE	C.C.	YEAR	FRONT					REAR				KITS KG	
			FD _{MF}	N°	DF	OE	UPGRADE 1	UPGRADE 2	FD _{MF}	DF	OE		UPGRADE
continue INDIAN MOTORCYCLE													
CHIEFTAIN DARK HORSE	1811	16	FD331	2	DF472	FLW	FLV			FD140	DF472	FLW	FLV
ROADMASTER	1811	15	FD331	2	DF472	FLW	FLV			FD140	DF472	FLW	FLV
SPRINGFIELD	1811	16	FD331	2	DF472	FLW	FLV			FD140	DF472	FLW	FLV
ISR													
6 PISTON RACING CALIPER		93	FD160	1									
6 PISTON RACING CALIPER		93	FD161	1									
ITALJET													
50 CRUISE	50	94	FD136	1	DF466	W				MF732	-		
50 PISTA	50	94	FD136	1	DF466	W				MF732	-		
50 SCOOP	50	94	FD136	1	DF466	W				MF732	-		
BAZOOKA	50	94	FD136	1	DF466	W				MF732	-		
DRAGSTER	50	98	FD065	1	DF624	W				FD065	DF625	W	
FORMULA	50	94	99	FD153	1	DF624	W			FD153	DF625	W	
FORMULA, LC	50	00	FD153	1	DF624	W				FD153	DF625	W	
JET SET	50	02	FD270	1						MF	-		
PISTA 2	50	92	FD136	1	DF466	W				MF732	-		
TORPEDO 50	50	00	FD065	1						MF	-		
VELOCIFERO	50	94	MF301		-					MF301	-		
YANKEE	50	94	FD136	1	DF466	W				MF	-		
MILLENNIUM 100	100	02	FD270	1						MF	-		
DRAGSTER	125	00	FD065	1	DF624	W				FD065	DF625	W	
FORMULA 125	125	97	FD065	1	DF624	W				FD065	DF625	W	
JACK 125	125	07	FD284	1						FD284			
JET SET	125	02	FD270	1						MF	-		
MILLENNIUM 125	125	00	01	FD075	1					MF	-		
MILLENNIUM 125	125	02	FD270	1						MF	-		
TORPEDO 125	125	99	06	FD065	1					MF	-		
TORPEDO 125	125	07	FD284	1						MF	-		
JACK 150	150	07	FD284	1						FD284			
JET SET	150	02	FD270	1						MF	-		
MILLENNIUM 150	150	00	01	FD075	1					MF	-		
MILLENNIUM 150	150	02	FD270	1						MF	-		
TORPEDO 150	150	00	FD065	1						MF	-		
DRAGSTER	180	00	FD065	1	DF624	W				FD065	DF625	W	
DRAGSTER	250	07	FD270	1						FD270			
JUPITER	250	02	FD169	1	DF458	W				FD214	DF490	W	
BAZOOKA	650	06	FD073	2						FD073			
GRIFON	650	06	FD073	2						FD073			
GRIFON	900	00	FD068	2	DF660	CW	CRW			FD012			
JIALING COLOMBIA													
JL 110-8 ECLIPSE	110		FD117	1						MF	-		
JL 110-11 PRINCE	110		FD117	1						MF	-		
JH 125 CICLON	125		FD095	1						MF	-		
JH 125-6 PEGASO	125		FD095	1						MF	-		
JH 125 G	125		FD076	1						MF	-		
JH 150 E LIBRETY	150		FD117	1						MF	-		
JINCHENG COLOMBIA													
JC 50 Q 5	50	05	FD136	1						MF	-		
JC 50 Q 9	50	05	FD136	1						MF	-		
VELOS	50	05	FD133	1						MF	-		
JC 70 Q 5	70	05	FD136	1						MF	-		
JC 70 Y	70	05	FD136	1						MF	-		
JC 90-7 GORILLA	90	05	FD136	1						MF	-		
JC 100	100		FD095	1						MF	-		
JC 110-2 CITY	110		FD073	1						MF	-		
JC 125	125		FD073	1						MF	-		
JC 125 7B	125		FD252	1						MF	-		
JC 125-17C GENTLE	125		FD117	1						MF	-		
JC125 T6 QUEEN	125		FD252	1						MF	-		
JC 150 DRAGON	150		FD252	1						MF	-		
JC 150 Y	150	05	FD097	1						MF	-		
JC 250 6	250	05	FD188	1						MF	-		
JC 250-6 MANTIS	250		FD117	1						MF	-		
JINCHENG 4 Wheels													
JC 125 S RACCOON	125	05	FD095	2						FD188			
JJUAN													
RADIAL 4P 34/30 100mm	DEL		FD176										
RADIAL 4P 34/30 108mm	DEL		FD176										
AXIAL 2P 25mm	TRAS									FD356			
AXIAL 2P 34mm	TRAS									FD356			
TOURING / SPORT ROAD BIKE	TRAS									FD165			
TOURING BIKE AXIAL 4P	DEL		FD176										



BRAND & MODEL · MARCA Y MODELO MARCA E MODELLO · MARQUE ET MODÈLE	C.C.	YEAR	FRONT					REAR				KITS KG
			FD _{MF}	N°	DF	OE	UPGRADE 1	UPGRADE 2	FD _{MF}	DF	OE	
continue JJUAN												
TOURING / SPORT ROAD BIKE RADIAL 4P	DEL		FD176									
SPORT BIKE 2P	TRAS							FD220				
SCOOTER AXIAL 2P	DEL		FD220					FD220				
SCOOTER 3P CBS	DEL		FD439									
TOURING BIKE AXIAL 2P	DEL		FD266									
JOTAGAS												
JTG 250	250	14	FD460	1	DF808			FD224	DF809	W		
JTG 280	280	14	FD460	1	DF808			FD224	DF809	W		
JTG 300	300	14	FD460	1	DF808			FD224	DF809	W		
JTG 300 JT	300	12	FD446	1	DF808	W		FD224	DF809	W		
KAWASAKI												
KX 60	60	94	FD086	1				MF	-			
KX 65	65	00	FD254	1	DF195	W		FD095	DF195	W		
KX 65	65	05	FD254	1	DF195	W		FD095	DF195	W		
KX 80	80	91	FD094	1	DF171	W		FD076				
KX 80	80	93	FD091	1	DF171	W		FD114	DF165	W		
KX 80 R7 KX 80-II	80	97	FD204	1	DF171	W		FD076	DF165	W		
KX 85	85	00	FD204	1	DF209	W		FD076	DF165	W		
KX 85	85	03	FD204	1	DF209	W		FD076	DF165	W		
KX 100	100	97	FD204	1	DF171	W		FD076	DF165	W		
KSR 110	110	03	FD095	1				FD095				
BN 125	125	05	FD145	1				MF	-			
ELIMINATOR	125	98	FD095	1				MF151	-			
ELIMINATOR	125	00	FD117	1				MF151	-			
J 125	125	16	FD266	1				FD438	DF307	W		
KDX 125 SR	125	90	FD094	1	DF164			FD114	DF152	W		
KL 125 ENDURO	125	03	FD164	1	DF150	FLW	FLS	FRS	FD286	DF179	W	WLL
KLX 125	125	10	FD086	1				FD095				
KLX 125 D-TRACKER	125	10	FD086	1				FD095				
KMX 125	125	99	FD177	1				FD075				
KX 125	125	95	FD164	1	DF150	FLW	FLS	FRS	FD093	DF151	W	
KX 125	125	03	FD164	1	DF182	FLW	FLS	FRS	FD093	DF179	W	WLL
KX 125	125	04	FD164	1	DF182	FLW	FLS	FRS	FD093	DF179	W	WLL
KX 125	125	06	FD164	1	DF200	FLW	FLS	FRS	FD093	DF179	W	WLL
NINJA 125	125	19	FD117	1	DF205	CW		FD117	DF204	W		KG200
Z 125	125	19	FD117	1	DF205	CW		FD117	DF204	W		
Z 125 PRO	125	17	FD504	1	DF366	W		FD095	DF367	W		
KLX 140 L	140	08	FD086	1				FD095				
EPSILON 150	150	03	FD177	1				MF	-			
KDX 200 SR	200	90	FD086	1				FD114				
KDX 220	220	99	FD164	1	DF164			FD114	DF152	W		
BJ 250 ESTRELLA RS	250	99	FD075	1				FD075				
D 250 TRACKER	250	03	FD164	1	DF150	FLW		FD093	DF152	W		
EL 250, E	250	91	FD062	1	DF166			MF	-			
EPSILON 250	250	03	FD222	1	DF341	W		FD400	DF342	W		
KDX 250 R	250	92	FD086	1	DF150	FLW	FLS	FRS	FD114	DF152	W	
KL 250 SUPER SHERPA	250	00	FD204	1				FD075				
KL 250 TR	250	04	FD179	1				MF	-			
KLX 250	250	09	FD086	1				FD093				
KLX 250 D TRACKER	250	00	FD164	1				FD093	DF152	W		
KLX 250 R	250	92	FD086	1	DF150	FLW	FLS	FRS	FD114			
KLX 250 S	250	05	FD164	1	DF150	FLW	FLS	FRS	FD093	DF152	W	
KLX 250 S	250	08	FD164	1	DF201	W		FD286	DF202	W		
KLX 250 SF	250	09	FD086	1				FD093				
KR-1S 250C2	250	90	FD107	1				FD104				
KXE 250 F	250	03	FD164	1	DF150	FLW	FLS	FRS	FD286			
KX 250	250	94	FD164	1	DF150	FLW	FLS	FRS	FD114	DF151	W	
KX 250	250	95	FD164	1	DF150	FLW	FLS	FRS	FD093	DF151	W	
KX 250	250	03	FD164	1	DF182	FLW	FLS	FRS	FD093	DF179	W	WLL
KX 250	250	04	FD164	1	DF182	FLW	FLS	FRS	FD286	DF179	W	WLL
KX 250	250	06	FD164	1	DF200	FLW	FLS	FRS	FD286	DF179	W	WLL
KX 250 F	250	04	FD164	1	DF182	FLW	FLS	FRS	FD286	DF179	W	WLL
KX 250 F	250	06	FD164	1	DF200	FLW	FLS	FRS	FD286	DF179	W	WLL
KX 250 F	250	11	FD164	1	DF200	FLW	FLS	FRS	FD286	DF179	W	WLL
KX 250 F	250	15	FD164	1	DF208	FLW	FLS	FRS	FD286	DF179	W	WLL
KX 250 F	250	20	FD164	1	DF208	FLW	FLS	FRS	FD286	DF149	W	WLL
NINJA 250 R	250	08	FD117	1	DF203	W		FD117	DF204	W		KG149
Z 250 SL	250	15	FD117	1	DF205	CW		FD117	DF204	W		
TR 250	250	05	FD179	1				MF	-			
ZR 250 BALIUS II	250	02	FD179	1	DF167	CW		FD075				
ZX 25 R	250	20	FD117	1	DF203	CW		FD117	DF214	W		
ZZR 250 (EX 250 H1)	250	90	FD090	2	DF167	CW		FD104				

APPLICATIONS

PADS FD

DISCS DF

SHOES MF

LINES FK

BRACKETS SP

KITS KG

CROSS REFERENCE





APPLICATIONS

PADS FD

DISCS DF

SHOES MF

LINES FK

BRACKETS SP

KITS KG

CROSS REFERENCE

BRAND & MODEL • MARCA Y MODELO MARCA E MODELLO • MARQUE ET MODÈLE	C.C.	YEAR	FRONT					REAR				KITS KG	
			FD _{MF}	N°	DF	OE	UPGRADE 1	UPGRADE 2	FD _{MF}	DF	OE		UPGRADE
continue KAWASAKI													
ZZR 250	250	98	FD090	1						FD075			
VN 250 ELIMINATOR	250	99	FD174	1						MF	-		
J 300	300	14	FD266	1						FD438	DF307	W	
J 300 SE	300	14	FD266	1						FD438	DF307	W	
KLX 300 R	300	96	FD164	1	DF150	FLW	FLS	FRS		FD093	DF152	W	
NINJA 300 R	300	13	FD117	1	DF205	CW				FD117	DF204	W	
NINJA 300 R SP (ABS)	300	13	FD117	1	DF205	CW				FD117	DF213	W	
VERSYS X 300	300	17	FD266	1	DF205	CW				FD117			
Z 300	300	15	FD117	1	DF205	CW				FD117	DF204	W	
KLX 400 R	400	03	FD164	1	DF150	FLW	FLS	FRS		FD093	DF151	W	
NINJA 400	400	18	FD532	1	DF214	FLW				FD117	DF213	W	
XANTHUS 400	400	92	FD104	2						FD075			
Z 400	400	20	FD532	1	DF214	FLW				FD117	DF213	W	
ZEPHYR 400 / X	400	02	FD090	2						FD167			
ZRX 400 / II	400	01	FD272	2	DF167	CW				FD167			
ZXR 400	400	90 94	FD141	2	DF169	CW				FD111	DF183	W	
ZXR 400	400	95 98	FD090	2	DF169	CW				FD111	DF183	W	
ZXR 400	400	99	FD156	2	DF169	CW				FD167			
ZZR 400	400	90 00	FD141	2						FD090			
ZZR 400	400	01	FD141	2						FD167			
KLX 450 R	450	07	FD164	1	DF200	FLW	FLS	FRS		FD286	DF179	W	WLL KG200
KX 450 F	450	06 10	FD164	1	DF200	FLW	FLS	FRS		FD286	DF179	W	WLL KG200
KX 450 F	450	11 14	FD164	1	DF200	FLW	FLS	FRS		FD286	DF179	W	WLL KG200
KX 450 F	450	15 18	FD164	1	DF208	FLW	FLS	FRS		FD286	DF179	W	WLL KG208
KX 450 F	450	19	FD164	1	DF208	FLW	FLS	FRS		FD286	DF149	W	WLL KG149
KXE 450 F	450	06	FD164	1	DF200	FLW	FLS	FRS		FD286	DF179	W	WLL KG200
EN 500	500	90 93	FD062	1	DF177	W				MF	-		
EN 500 VULCAN	500	94	FD062	1	DF173					MF	-		
ER-5	500	97 00	FD090	1	DF154	W				MF	-		
ER-5	500	01	FD174	1	DF154	W				MF	-		
GPZ 500 S	500	90 92	FD075	2	DF159	W				MF	-		
GPZ 500 S	500	93	FD104	2	DF159	W				FD075			
KLE 500	500	91	FD090	1	DF175	W				FD075	DF157	W	
KX 500	500	94 94	FD164	1	DF150	FLW	FLS	FRS		FD114	DF151	W	
KX 500	500	95	FD164	1	DF150	FLW	FLS	FRS		FD093	DF151	W	
ZEPHYR 500	500	91	FD090	2						FD104			
ZZR 500	500	90	FD107	2						FD090			
ZEPHYR 550	550	93 95	FD090	2	DF167	CW				FD104	DF183	W	
ZEPHYR 550	550	96	FD090	2	DF167	CW				FD167	DF183	W	
KLR 600S	600	90 92	FD075	1	DF153					MF	-		
ZL 600 ELIMINATOR	600	95	FD090	1	DF167	CW				MF	-		
ZX 600 NINJA ZX-6	600	93 94	FD107	2	DF167	CW				FD090	DF188	W	
ZX-6R	600	95 97	FD107	2	DF167	CW				FD167	DF188	W	
ZX-6R	600	98 99	FD156	2	DF178	CW				FD167	DF193	W	
ZX-6R	600	00 02	FD156	2	DF167	CW				FD167	DF193	W	
ZX-6RR	600	03 04	FD290	2	DF180	CW				FD167	DF193	W	
ZX-6RR	600	05 06	FD290	2	DF184	CW	CRW			FD167	DF193	W	
ZX-6R	600	07 08	FD371	2	DF184	CW	CRW			FD167	DF193	W	
ZX-6R	600	09	FD371	2	DF184	CW	CRW			FD167	DF193	W	
ZZR 600	600	91 92	FD107	2	DF167	CW				FD090	DF188	W	
ZZR 600	600	93	FD107	2	DF167	CW				FD167	DF183	W	
ZZR 600 HAMA	600	90	FD107	2	DF167	CW				FD090			
ZX-6R 636	636	02 02	FD156	2	DF167	CW				FD167	DF193	W	
ZX-6R 636	636	03 04	FD290	2	DF180	CW				FD167	DF193	W	
ZX-6R 636	636	05 12	FD290	2	DF184	CW	CRW			FD167	DF193	W	
ZX-6R 636	636	13	FD219	2	DF190	CW	CRW			FD363	DF193	WA	
ZX-6R 636 ABS	636	13	FD219	2	DF190	CW	CRW			FD363	DF193	WA	
ER-6 F / NINJA 650 R (USA) LEFT / IZQ	650	05	FD174	2	DF184	CW	CRW						
ER-6 F / NINJA 650 R (USA) RIGHT / DER	650	05	FD179	2	DF184	CW	CRW			FD167	DF193	W	
ER-6 N LEFT / IZQ	650	05	FD174	2	DF184	CW	CRW						
ER-6 N RIGHT / DER	650	05	FD179	2	DF184	CW	CRW			FD167	DF193	W	
KLR 650 C1/C2	650	95 07	FD174	1						FD075	DF157	W	
KLR 650	650	08	FD086	1						FD145			
KLX 650 R	650	93	FD164	1	DF150	FLW	FLS	FRS		FD114			
KLX 650 S	650	93	FD164	1	DF170					FD114			
NINJA 650	650	17	FD266	2	DF215	CW	FLW			FD134	DF193	WA	
VERSYS 650 LEFT / IZQ	650	06 07	FD174	1	DF184	CW	CRW						
VERSYS 650 RIGHT / DER	650	06 07	FD179	1	DF184	CW	CRW			FD167	DF193	W	
VERSYS 650 LEFT / IZQ ABS	650	06 07	FD174	1									
VERSYS 650 RIGHT / DER ABS	650	06 07	FD179	1						FD167			
VERSYS 650 LEFT / IZQ	650	08 09	FD174	1	DF184	CW	CRW						



BRAND & MODEL · MARCA Y MODELO MARCA E MODELLO · MARQUE ET MODÈLE	C.C.	YEAR	FRONT						REAR				KITS KG	
			FD _{MF}	N°	DF	OE	UPGRADE 1	UPGRADE 2	FD _{MF}	DF	OE	UPGRADE		
continue KAWASAKI														
VERSYS 650 RIGHT / DER	650	08	09	FD179	1	DF184	CW	CRW			FD167	DF193	W	
VERSYS 650 LEFT / IZQ ABS	650	08	09	FD174	1									
VERSYS 650 RIGHT / DER ABS	650	08	09	FD179	1						FD167			
VERSYS 650 LEFT / IZQ	650	10	14	FD174	1	DF184	CW	CRW						
VERSYS 650 RIGHT / DER	650	10	14	FD179	1	DF184	CW	CRW			FD167	DF193	W	
VERSYS 650 LEFT / IZQ ABS	650	10	14	FD174	1									
VERSYS 650 RIGHT / DER ABS	650	10	14	FD179	1						FD167			
VERSYS 650 ABS	650	15		FD266	2						FD134			
VULCAN S	650	15		FD205	1	DF184	CW				FD134			
VULCAN S CAFÉ	650	16		FD205	1	DF184	CW				FD134			
VULCAN S SE	650	16		FD205	1	DF184	CW				FD134			
W 650	650	99		FD179	1	DF167	CW			MF	-			
Z 650	650	17		FD266	2	DF215	CW	FLW		FD103	DF193	WA		
Z 650 RS	650	20		FD266	2	DF215	CW	FLW		FD103				
VN 750 VULCAN	750	93		FD062	2	DF166				MF	-			
Z 750 LEFT / IZQ	750	04	06	FD174	2	DF167	CW							
Z 750 RIGHT / DER	750	04	06	FD179	2	DF167	CW			FD167	DF193	W		
Z 750 S LEFT / IZQ	750	05	06	FD174	2	DF167	CW							
Z 750 S RIGHT / DER	750	05	06	FD179	2	DF167	CW			FD167	DF193	W		
Z 750	750	07		FD266	2	DF184	CW	CRW		FD134	DF191	W		
Z 750 ABS	750	07		FD266	2	DF184	CW	CRW		FD134	DF191	W		
Z 750 R	750	11		FD371	2	DF184	CW	CRW		FD457	DF191	W		
Z 750 R SE	750	12		FD371	2	DF184	CW	CRW		FD457	DF191	W		
ZEPHYR 750	750	91		FD090	2	DF167	CW			FD090	DF188	W		
ZR-7 S DER./RIGHT	750	99	04	FD179	2	DF167	CW							
ZR-7 S IZQ/LEFT	750	99	04	FD174	2	DF167	CW			FD179				
ZR-7 S DER./RIGHT	750	05		FD179	2	DF167	CW							
ZR-7 S IZQ/LEFT	750	05		FD174	2	DF167	CW			FD179				
ZX 7 RR (ZX750P1)	750	96		FD193	2	DF168	CW	CRW		FD267	DF155	W		
ZXR 750 R	750	91	95	FD107	2	DF168	CW	CRW		FD111	DF155	W		
VN 800	800	94	97	FD062	1	DF173				FD062				
VN 800 CLASSIC	800	98		FD174	1	DF173				MF	-			
VN 800 DRIFTER	800	99		FD174	1					FD179				
VN 800 VULCAN	800	95		FD047	1					MF	-			
W 800	800	11		FD179	1	DF167	CW			MF	-			
Z 800	800	13		FD331	2	DF190	CW	CRW		FD457	DF191	W		
Z 800 ABS	800	13		FD331	2	DF190	CW	CRW		FD457	DF191	W		
Z 800e	800	13		FD266	2	DF190	CW	CRW		FD457	DF191	W		
Z 800e ABS	800	13		FD331	2	DF190	CW	CRW		FD457	DF191	W		
GPZ 900 R	900	90	96	FD266	2	DF167	CW			FD090	DF159	W		
VN 900	900	07		FD174	1					FD179				
VN 900 CLASIC	900	06		FD174	1					FD179				
VN 900 CLASIC SPECIAL EDITION	900	11		FD174	1					FD179				
Z 900	900	17		FD331	2	DF215	CW	FLW		FD457	DF191	W		
Z 900 RS	900	18		FD325	2	DF215	CW	FLW		FD134	DF191	W		
Z 900 RS CAFÉ	900	18		FD325	2	DF215	CW	FLW		FD134	DF191	W		
ZX-9R NINJA	900	94	95	FD107	2	DF168	CW	CRW		FD167	DF155	W		
ZX-9R NINJA	900	96	97	FD156	2	DF168	CW	CRW		FD167	DF155	W		
ZX-9R NINJA	900	98	99	FD156	2	DF178	CW			FD167	DF193	W		
ZX-9R NINJA	900	00	01	FD156	2	DF169	CW			FD167	DF193	W		
ZX-9R NINJA	900	02		FD331	2	DF168	CW	CRW		FD167	DF193	W		
GTR 1000	1000	94		FD090	2	DF167	CW			FD062	DF154	W		
KLV 1000 LEFT / IZQ	1000	04		FD174	2	DF323	CW	CRW						
KLV 1000 RIGHT / DER	1000	04		FD179	2	DF323	CW	CRW		FD134	DF361	W		
Z H2	1000	20		FD475	2					FD167				
NINJA H2 (200cv)	1000	15		FD373	2					FD220				
NINJA H2 R (310cv)	1000	15		FD373	2					FD220				
NINJA H2 SX	1000	18		FD325	2					FD117				
NINJA H2 SX SE	1000	20		FD373	2					FD117				
NINJA H2 SXE	1000	18		FD325	2					FD117				
VERSYS 1000	1000	12	14	FD107	2	DF184	CW	CRW		FD134	DF191	W		
VERSYS 1000	1000	15	18	FD107	2	DF190	CW	CRW		FD134	DF191	W		
VERSYS 1000	1000	19		FD325	2	DF190	CW	CRW		FD134	DF191	W		
VERSYS 1000 SE	1000	19		FD325	2	DF190	CW	CRW		FD134	DF191	W		
VERSYS 1000 TOURER	1000	17		FD107	2	DF190	CW	CRW		FD134	DF191	W		
VERSYS 1000 GRAND TOURER	1000	17		FD107	2	DF190	CW	CRW		FD134	DF191	W		
Z 1000	1000	03	06	FD331	2	DF167	CW			FD167	DF193	W		
Z 1000	1000	07	08	FD371	2	DF184	CW	CRW		FD134	DF191	W		
Z 1000	1000	08	09	FD371	2	DF184	CW	CRW		FD134	DF191	W		
Z 1000	1000	10	13	FD325	2	DF184	CW	CRW		FD167	DF191	W		
Z 1000	1000	14		FD325	2	DF190	CW	CRW		FD167	DF191	W		
Z 1000 ABS	1000	14		FD325	2	DF190	CW	CRW		FD167	DF191	W		



APPLICATIONS
 PADS FD
 DISCS DF
 SHOES MF
 LINES FK
 BRACKETS SP
 KITS KG
 CROSS REFERENCE



APPLICATIONS

PADS FD

DISCS DF

SHOES MF

LINES FK

BRACKETS SP

KITS KG

CROSS REFERENCE

BRAND & MODEL · MARCA Y MODELO MARCA E MODELLO · MARQUE ET MODÈLE	C.C.	YEAR	FRONT					REAR				KITS KG
			FD _{MF}	N°	DF	OE	UPGRADE 1	UPGRADE 2	FD _{MF}	DF	OE	
continue KAWASAKI												
Z 1000 R EDITION	1000	17	FD373	2	DF190	CW	CRW	FD167	DF191	W		
Z 1000 SX	1000	11	FD325	2	DF184	CW	CRW	FD167	DF191	W		
ZG 1000 CONCOURS	1000	94	FD090	2				FD090				
ZX 10R	1000	04	FD290	2	DF184	CW	CRW	FD167	DF193	W		
ZX 10R	1000	06	FD290	2	DF184	CW	CRW	FD167	DF193	W		
ZX 10R	1000	08	FD325	2	DF190	CW	CRW	FD167	DF193	W		
ZX 10R	1000	11	FD325	2	DF190	CW	CRW	FD363	DF193	WA		
ZX 10R ABS	1000	11	FD325	2	DF190	CW	CRW	FD363	DF193	WA		
ZX 10R ABS	1000	16	FD373	2	DF194	CW		FD363	DF193	WA		
ZX 10RR ABS	1000	17	FD373	2	DF211	CW		FD363	DF193	WA		
ZX 10R SE	1000	18	FD373	2	DF211	CW		FD363	DF193	WA		
GPZ 1100 (ZX1100E1) LEFT/IZQ	1100	95	FD174	2	DF167	CW						
GPZ 1100 (ZX1100E1) RIGHT/DER	1100	95	FD179	2	DF167	CW		FD167				
GPZ 1100 S	1100	95	FD266	2	DF167	CW		FD111				
ZEPHYR 1100	1100	92	FD107	2	DF169	CW		FD090	DF196	W		
ZEPHYR 1100	1100	93	FD090	2	DF169	CW		FD090	DF196	W		
ZEPHYR 1100 LEFT/IZQ	1100	96	FD174	2	DF169	CW						
ZEPHYR 1100 RIGHT/DER	1100	96	FD179	2	DF169	CW		FD090	DF196	W		
ZRX 1100	1100	97	FD156	2	DF169	CW		FD111	DF197	W		
ZX 1100	1100	93	FD107	2				FD111				
ZZR 1100	1100	90	FD107	2	DF169	CW		FD090	DF161	W		
ZZR 1100	1100	93	FD107	2	DF168	CW	CRW	FD111	DF186	W		
ZZR 1200	1200	01	FD107	2	DF168	CW	CRW	FD111	DF197	W		
ZRX 1200	1200	04	FD156	2	DF168	CW	CRW	FD111	DF198	W		
ZRX 1200 S	1200	02	FD156	2	DF169	CW		FD111	DF198	W		
ZRX 1200 S	1200	04	FD156	2	DF169	CW		FD111	DF198	W		
ZRX 1200 R	1200	04	FD156	2	DF169	CW		FD111	DF198	W		
ZX-12 R	1200	00	FD156	2	DF168	CW	CRW	FD111	DF199	W		
ZX-12 R	1200	04	FD290	2	DF167	CW		FD111	DF199	W		
GTR 1400	1400	07	FD371	2	DF190	CW	CRW	FD267				
GTR 1400	1400	10	FD371	2	DF190	CW	CRW	FD267				
GTR 1400 GRAND TOUR	1400	10	FD371	2	DF190	CW	CRW	FD267				
ZG 1400 CONCOURS	1400	08	FD371	2	DF190	CW	CRW	FD267				
ZG 1400 CONCOURS ABS	1400	08	FD371	2	DF190	CW	CRW	FD267	DF206	W		
ZG 1400 CONCOURS ABS	1400	10	FD371	2	DF190	CW	CRW	FD267	DF206	W		
ZZR 1400	1400	06	FD371	2	DF190	CW	CRW	FD267	DF191	W		
ZZR 1400	1400	12	FD371	2	DF190	CW	CRW	FD267	DF191	W		
ZZR 1400 PERFORMANCE SPORT	1400	16	FD373	2	DF190	CW	CRW	FD267	DF191	W		
ZX-14 R	1400	06	FD371	2	DF190	CW	CRW	FD267	DF191	W		
ZX-14 R ABS	1400	14	FD371	2	DF190	CW	CRW	FD267	DF191	W		
VN 1500 DRIFTER	1500	02	FD174	1				FD179				
VN 1500 MEAN STREAK	1500	01	FD156	2	DF168	CW	CRW	FD179				
VN 1500 SUMO	1500	94	FD062	1	DF173			FD062				
VN-15 SE	1500	93	FD062	1	DF173			FD062				
VN-CLASSIC	1500	96	FD174	1	DF173			FD062				
VN-EASSIC Fi	1500	00	FD174	1				FD179				
VN-CLASSIC TOURER LEFT/IZQ	1500	98	FD174	2								
VN-CLASSIC TOURER RIGHT/DER	1500	98	FD179	2				FD062				
VN-TOURER LEFT/IZQ	1500	03	FD174	2								
VN-TOURER RIGHT/DER	1500	03	FD179	2				FD179				
VN 1600 MEAN STREAK	1600	04	FD156	2	DF168	CW	CRW	FD179				
VN 1600 MEAN STREAK	1600	05	FD290	2				FD179				
VN 1600 SUMO/CLASSIC LEFT/IZQ	1600	03	FD174	2								
VN 1600 SUMO/CLASSIC RIGHT/DER	1600	03	FD179	2				FD179				
VN 1600 NOMAD LEFT/IZQ	1600	05	FD174	2								
VN 1600 NOMAD RIGHT/DER	1600	05	FD179	2				FD179				
VN 1700 CLASSIC LEFT/IZQ	1700	09	FD174	2	DF373	W						
VN 1700 CLASSIC RIGHT/DER	1700	09	FD179	2	DF373	W		FD179				
VN 1700 CLASSIC TOURER LEFT/IZQ	1700	09	FD174	2	DF373	W						
VN 1700 CLASSIC TOURER RIGHT/DER	1700	09	FD179	2	DF373	W		FD179				
VN 1700 CLASSIC ABS	1700	12	FD107	2	DF373	W		FD179				
VN 1700 CLASSIC TOURER ABS	1700	12	FD107	2	DF373	W		FD179				
VN 1700 CLASSIC NOMAD ABS	1700	12	FD107	2	DF373	W		FD179				
VN 1700 VOYAGER	1700	09	FD107	2	DF373	W		FD179				
VN 1700 VOYAGER CUSTOM ABS	1700	11	FD107	2	DF373	W		FD179				
VN 2000	2000	04	FD107	2				FD179				
KAWASAKI 4 Wheels												
KEF 300 LAKOTA	300	95	FD075	2				FD076				
KEF 300 LAKOTA SPORT	300	95	FD075	2				FD076				
KVF 300	300	99	FD095	2				MF	-			
KVF 300	300	13	FD336	2				FD336				
KFX 400	400	03	FD076	2	DF894	W		FD076	DF048	W		



BRAND & MODEL • MARCA Y MODELO MARCA E MODELLO • MARQUE ET MODÈLE	C.C.	YEAR	FRONT					REAR				KITS KG	
			FD _{MF}	N°	DF	OE	UPGRADE 1	UPGRADE 2	FD _{MF}	DF	OE		UPGRADE
continue KAWASAKI 4 Wheels													
KLF 400 B1 BAYOU LEFT/IZQ.	400	93	99	FD086	2								
KLF 400 B1 BAYOU RIGHT/DER.	400	93	99	FD117	2					FD117			
KVF 400 PRAIRIE	400	97		FD095	2					MF	-		
KFX 450 R LEFT/IZQ.	450	07		FD319	2	DF731	W						
KFX 450 R RIGHT/DER.	450	07		FD321	2	DF731	W			FD076	DF869	W	
KVF 650 BRUTE FORCE 4X4 DER.	650	05		FD319	2					MF	-		
KVF 650 BRUTE FORCE 4X4 IZQ.	650	05		FD321	2					MF	-		
KVF 650 PRAIRIE DER.	650	02		FD319	2								
KVF 650 PRAIRIE IZQ.	650	02		FD321	2					MF	-		
KFX 700 DER.	700	03		FD319	2	DF731	W			MF	-		
KFX 700 IZQ.	700	03		FD321	2	DF731	W			MF	-		
KFX 700 TEAM GREEN DER.	700	05		FD319	2	DF731	W			MF	-		
KFX 700 TEAM GREEN IZQ.	700	05		FD321	2	DF731	W			MF	-		
KSV 700 DER	700	04	11	FD321	2					MF	-		
KSV 700 IZQ	700	04	11	FD319	2					MF	-		
KVF 700 DER D1	700	05		FD321	2					MF	-		
KVF 700 IZQ D1	700	05		FD319	2					MF	-		
KFX 750 BRUTE FORCE 4X4 DER.	750	04		FD117	2								
KFX 750 BRUTE FORCE 4X4 IZQ.	750	04		FD086	2					MF	-		
KRF 750 (TODOS) DER.	750	08		FD117	2					MF	-		
KRF 750 (TODOS) IZQ.	750	08		FD086	2					MF	-		
KVF 750 DER.	750	08		FD117	2					MF	-		
KVF 750 IZQ.	750	08		FD086	2					MF	-		
KASEA 4 Wheels													
KS 90	90	03		MF		-				FD086			
KU 90	90	03		MF		-				FD086			
SKYHAWK 125	125	03		MF		-				FD086			
KS 150	150	03		MF		-				FD086			
KU 150	150	03		MF		-				FD086			
SKYHAWK 170	170	03		MF		-				FD086			
SKYHAWK 250	250	03		MF		-				FD086			
KEEWAY													
ARN 50	50	10		FD012	1					MF	-		
F ACT 50 / RACING	50	07		FD175	1					MF	-		
F NKD 50	50	09		FD175	1					MF	-		
FLASH 50	50	07		FD175	1					MF	-		
FOCUS 50	50	05		FD175	1	DF037	W	RW	FLS	MF	-		
GOCCIA 50	50	07		FD153	1					MF	-		
HACKER	50	08		FD153	1					MF	-		
HURRICANE 50	50	05		FD094	1					MF	-		
MATRIX 50	50	05		FD175	1					MF	-		
PIXEL 50	50	08		FD094	1					MF	-		
SWAN 50	50	05		FD094	1					MF	-		
TX 50	50	10		FD162	1					FD048			
X-RAY	50	07		FD162	1					FD048			
X-RAY SC SUPERMOTO	50	07		FD162	1					FD048			
ARN 125	125	05		FD153	1					MF	-		
F ACT 125 / RACING	125	08		FD175	1					MF	-		
FOCUS 125	125	07		FD094	1					MF	-		
HACKER 125	125	08		FD012	1					MF	-		
K2 125	125	07		FD277	1					FD277			
KW 125	125	10		FD252	1					MF	-		
MATRIX 125	125	06	06	FD094	1					MF	-		
MATRIX 125	125	07		FD175	1					MF	-		
OUTLOOK 125	125	07	08	FD187	1	DF007	W			FD187			
OUTLOOK 125	125	10		FD086	1					FD187			
SILVER BLADE 125	125	07		FD138	2					FD214			
SPEED 125	125	07		FD252	1					FD252	-		
SUPERLIGHT 125	125	07		FD187	1					MF	-		
TX 125	125	10		FD162	1					FD048			
VIVA 125	125	05		FD175	1					FD175			
VIVA II 125	125	05		FD086	1					FD175			
ARSEN 150	150	10		FD252	1					MF	-		
K2 150	150	07		FD277	1					FD277			
KW 150	150	10		FD252	1					MF	-		
OUTLOOK 150	150	07	08	FD187	1	DF007	W			FD187			
OUTLOOK 150	150	10		FD086	1					FD187			
SILVER BLADE 150	150	07		FD138	2					FD214			
SPEED 150	150	09		FD252	1					FD073			
VIVA II 150	150	05		FD086	1					FD175			
CRUISER 250	250	10		FD086	1					FD073			
K2 250	250	07		FD277	1					FD277			





APPLICATIONS

PADS FD

DISCS DF

SHOES MF

LINES FK

BRACKETS SP

KITS KG

CROSS REFERENCE

BRAND & MODEL • MARCA Y MODELO MARCA E MODELLO • MARQUE ET MODÈLE	C.C.	YEAR	FRONT					REAR				KITS KG	
			FD	N°	DF	OE	UPGRADE 1	UPGRADE 2	FD	DF	OE		UPGRADE
continue KEEWAY													
SILVER BLADE 250	250	07	FD138	2						FD214			
KEEWAY 4 Wheels													
DRAGON 250	250	08	FD094	2						FD095			
KREIDLER													
E 50 FLORETT	50	08	FD086	1						MF	-		
G 50 FLORETT	50	08	FD086	1						MF	-		
ENDURO 125 DD	125	08	FD086	1						FD095			
G 125 FLORETT	125	08	FD095	1						MF	-		
NAKED 125 DD RIGHT/DER.	125	08	FD086	2									
NAKED 125 DD LEFT/IZQ.	125	08	FD117	2						FD103			
SUPERMOTO 125 DD	125	08	FD086	1						FD095			
SUPERMOTO 250 DD	250	08	FD086	1						FD095			
KTM													
FREERIDE	EL	12	14	FD458	1	DF796	W			FD441	DF797	W	
FREERIDE E-EXC	EL	18		FD458	1	DF796	W			FD441	DF797	W	
FREERIDE E-SM	EL	15		FD458	1	DF796	W			FD441	DF797	W	
FREERIDE E-SX	EL	15		FD458	1	DF796	W			FD441	DF797	W	
FREERIDE E-XC	EL	15		FD458	1	DF796	W			FD441	DF797	W	
SX-E	EL	20		FD230	1	DF779	W			FD230	DF779	W	
50 CHRONO	50	95		FD170	1					MF630	-		
50 GO	50	95		FD084	1					MF630	-		
50 SCOOTER	50	94		FD153	1	DF629	W	RW	FLS	MF630	-		
50 LC PRO SENIOR	50	04		FD230	1					FD230			
50 SM	50	06		FD230	1					FD230			
50 SX	50	06	13	FD230	1	DF779	W			FD230	DF780	W	
50 SX	50	14		FD230	1	DF779	W			FD230	DF779	W	
EXC 50	50	99		FD133	1	DF658	W			FD065			
60 SX	60	99		FD065	1	DF637	W			MF	-		
65 SX	65	00	01	FD065	1	DF637	W			FD048	DF639	W	
65 SX	65	02	03	FD265	1	DF688	W			FD048	DF639	W	
65 SX	65	04	08	FD265	1	DF688	W			FD230	DF689	W	
65 SX	65	09		FD265	1	DF688	W			FD265	DF689	W	
65 XC	65	08		FD265	1	DF688	W			FD230	DF689	W	
80 MX	80	92	01	FD012	1					MF	-		
85 SX	85	03	06	FD265	1	DF685	W			FD265	DF686	W	
85 SX	85	07	10	FD265	1	DF777	W			FD265	DF778	W	
85 SX	85	11	11	FD265	1	DF777	W			FD441	DF797	W	
85 SX 17/14	85	12		FD458	1	DF777	W			FD441	DF797	W	
85 SX 19/16	85	13		FD458	1	DF794	W			FD441	DF797	W	KG794
105 SX (USA)	105	04	06	FD265	1	DF685	W			FD265	DF686	W	
105 XC	105	07		FD265	1	DF777	W			FD265	DF778	W	
125 DUKE	125	11		FD450	1	DF789	CW			FD165	DF790	W	
125 DUKE ABS	125	14		FD450	1	DF800	CW			FD165	DF790	W	
125 ENDURO	125	92	92	FD128	1					FD075	DF607	W	WLL
125 ENDURO	125	93		FD138	1	DF606	W	FLW	FLS	FD075	DF607	W	WLL
125 EXC/EGS/SX	125	95	03	FD138	1	DF606	W	FLW	FLS	FD165	DF607	W	WLL
125 EXC	125	04		FD138	1	DF606	W	FLW	FLS	FD291	DF607	W	WLL
125 GS	125	91	92	FD128	1					FD075	DF607	W	WLL
125 GS	125	93	93	FD138	1	DF606	W	FLW	FLS	FD075	DF607	W	WLL
125 GS	125	94	94	FD138	1	DF606	W	FLW	FLS	FD165	DF607	W	WLL
125 MX	125	92	95	FD138	1	DF606	W	FLW	FLS	FD075	DF607	W	WLL
125 SX	125	93	93	FD138	1	DF606	W	FLW	FLS	FD075	DF607	W	WLL
125 SX	125	94	03	FD138	1	DF606	W	FLW	FLS	FD165	DF607	W	WLL
125 SX	125	04		FD138	1	DF606	W	FLW	FLS	FD291	DF607	W	WLL
125 XC-W	125	19		FD138	1	DF606	W	FLW	FLS	FD291	DF607	W	WLL
RC 125	125	14	15	FD450	1	DF789	CW			FD165	DF790	W	
RC 125 ABS	125	16		FD450	1	DF800	CW			FD165	DF790	W	
144 SX	144	08		FD138	1	DF606	W	FLW	FLS	FD291	DF607	W	WLL
150 SX 17/14	150	15	18	FD458	1	DF777	W			FD441	DF797	W	
150 SX 19/16	150	15	18	FD458	1	DF794	W			FD441	DF797	W	KG794
150 SX	150	19		FD138	1	DF606	W	FLW	FLS	FD291	DF607	W	WLL
150 XC	150	10		FD138	1	DF606	W	FLW	FLS	FD291	DF607	W	WLL
150 XC-W	150	19		FD138	1	DF606	W	FLW	FLS	FD291	DF607	W	WLL
200 DUKE	200	12		FD450	1	DF789	CW			FD165	DF790	W	
200 DUKE ABS	200	14		FD450	1	DF800	CW			FD165	DF790	W	
200 EXC	200	98	03	FD138	1	DF606	W	FLW	FLS	FD165	DF607	W	WLL
200 EXC	200	04		FD138	1	DF606	W	FLW	FLS	FD291	DF607	W	WLL
200 EGS	200	99	02	FD138	1	DF606	W	FLW	FLS	FD165	DF607	W	WLL
200 SX	200	03	03	FD138	1	DF606	W	FLW	FLS	FD165	DF607	W	WLL
200 SX	200	04		FD138	1	DF606	W	FLW	FLS	FD291	DF607	W	WLL
RC 200	200	14		FD450	1	DF789	CW			FD165	DF790	W	
250 EGS	250	99		FD138	1	DF606	W	FLW	FLS	FD165	DF607	W	WLL



BRAND & MODEL · MARCA Y MODELO MARCA E MODELLO · MARQUE ET MODÈLE	C.C.	YEAR	FRONT						REAR				KITS	
			FD _{MF}	N°	DF	OE	UPGRADE 1	UPGRADE 2	FD _{MF}	DF	OE	UPGRADE		KG
continue KTM														
250 ENDURO	250	92	92	FD128	1	DF606	W	FLW	FLS	FD075	DF607	W	WLL	
250 ENDURO	250	93		FD138	1	DF606	W	FLW	FLS	FD075	DF607	W	WLL	
250 EXC/EGS/SX	250	94	02	FD138	1	DF606	W	FLW	FLS	FD165	DF607	W	WLL	
250 EXC / 4T	250	03	03	FD138	1	DF606	W	FLW	FLS	FD165	DF607	W	WLL	
250 EXC / 4T	250	04		FD138	1	DF606	W	FLW	FLS	FD291	DF607	W	WLL	
250 EXC F	250	15		FD138	1	DF606	W	FLW	FLS	FD291	DF607	W	WLL	KG606
250 EXC - TPI / SIX DAYS	250	19		FD138	1	DF606	W	FLW	FLS	FD291	DF607	W	WLL	KG606
250 FREERIDE	250	13		FD458	1	DF796	W			FD441	DF797	W		
250 FREERIDE F	250	18		FD458	1	DF796	W			FD441	DF797	W		
250 GS	250	91	92	FD128	1					FD075	DF607	W	WLL	
250 GS	250	93	93	FD138	1	DF606	W	FLW	FLS	FD075	DF607	W	WLL	
250 GS	250	94		FD138	1	DF606	W	FLW	FLS	FD165	DF607	W	WLL	
250 MX	250	92	92	FD138	1					FD075	DF607	W	WLL	
250 MX	250	03		FD138	1	DF606	W	FLW	FLS	FD165	DF607	W	WLL	
250 SX, EGS, EXC	250	93	93	FD138	1	DF606	W	FLW	FLS	FD075	DF607	W	WLL	
250 SX	250	94	02	FD138	1	DF606	W	FLW	FLS	FD165	DF607	W	WLL	
250 SX	250	03		FD138	1	DF606	W	FLW	FLS	FD291	DF607	W	WLL	
250 SX F	250	15		FD138	1	DF606	W	FLW	FLS	FD291	DF607	W	WLL	KG606
250 F	250	06		FD138	1	DF606	W	FLW	FLS	FD291	DF607	W	WLL	
250 XC / F / W	250	06		FD138	1	DF606	W	FLW	FLS	FD291	DF607	W	WLL	
300 ENDURO	300	92	92	FD128	1	DF606	W	FLW	FLS	FD075	DF607	W	WLL	
300 ENDURO	300	93		FD138	1	DF606	W	FLW	FLS	FD075	DF607	W	WLL	
300 EXC	300	03	03	FD138	1	DF606	W	FLW	FLS	FD165	DF607	W	WLL	
300 EXC	300	04		FD138	1	DF606	W	FLW	FLS	FD291	DF607	W	WLL	
300 EXC - E	300	08		FD138	1	DF606	W	FLW	FLS	FD291	DF607	W	WLL	KG606
300 EXC - F / SIX DAYS	300	19		FD138	1	DF606	W	FLW	FLS	FD291	DF607	W	WLL	KG606
300 EXC - TPI / SIX DAYS	300	19		FD138	1	DF606	W	FLW	FLS	FD291	DF607	W	WLL	KG606
300 GS	300	91		FD128	1					FD075	DF607	W	WLL	
300 MXC	300	04		FD138	1	DF606	W	FLW	FLS	FD291	DF607	W	WLL	
300 SX, EGS, EXC	300	93	03	FD138	1	DF606	W	FLW	FLS	FD075	DF607	W	WLL	
300 XC / W	300	06		FD138	1	DF606	W	FLW	FLS	FD291	DF607	W	WLL	
350 EXC F	350	12		FD138	1	DF606	W	FLW	FLS	FD291	DF607	W	WLL	KG606
350 FREERIDE	350	12		FD458	1	DF796	W			FD441	DF797	W		
350 LC4 EXC	350	94		FD138	1	DF606	W	FLW	FLS	FD165	DF607	W	WLL	
350 MX	350	91	91	FD075	1					FD075	DF607	W	WLL	
350 MX	350	92		FD138	1	DF606	W	FLW	FLS	FD075	DF607	W	WLL	
350 SX FACTORY	350	10		FD138	1	DF606	W	FLW	FLS	FD291	DF607	W	WLL	KG606
350 SX F	350	11		FD138	1	DF606	W	FLW	FLS	FD291	DF607	W	WLL	KG606
350 XC F	350	11		FD138	1	DF606	W	FLW	FLS	FD291	DF607	W	WLL	KG606
390 ADVENTURE	390	20		FD450	1	DF940	CW			FD165	DF790	W		
390 DUKE	390	13		FD450	1	DF789	CW			FD165	DF790	W		
390 DUKE ABS	390	14	16	FD450	1	DF800	CW			FD165	DF790	W		
390 DUKE ABS	390	17		FD450	1	DF940	CW			FD165	DF790	W		
RC 390	390	14	16	FD450	1	DF845	CW			FD165	DF790	W		
RC 390	390	17		FD450	1	DF940	CW			FD165	DF790	W		
400 EXC	400	04		FD138	1	DF606	W	FLW	FLS	FD291	DF607	W	WLL	
400 LC4 EGS	400	94	95	FD138	1	DF606	W	FLW	FLS	FD165	DF607	W	WLL	
400 LC4 EGS	400	96		FD138	1	DF672	FLW			FD165				
440 SX	440	94		FD138	1	DF606	W	FLW	FLS	FD165	DF607	W	WLL	
450 EXC	450	03	03	FD138	1	DF606	W	FLW	FLS	FD165	DF607	W	WLL	
450 EXC	450	04		FD138	1	DF606	W	FLW	FLS	FD291	DF607	W	WLL	
450 EXC - F / SIX DAYS	450	19		FD138	1	DF606	W	FLW	FLS	FD291	DF607	W	WLL	KG606
450 EXC - R	450	08		FD138	1	DF606	W	FLW	FLS	FD291	DF607	W	WLL	KG606
450 MXC	450	04		FD138	1	DF606	W	FLW	FLS	FD291	DF607	W	WLL	
450 RALLY	450	11		FD138	1	DF672	FLW			FD291				
450 SMR	450	07		FD304	1	DF672	FLW			FD291	DF607	W	WLL	
450 SX	450	03		FD138	1	DF606	W	FLW	FLS	FD291	DF607	W	WLL	
450 SXF	450	07		FD138	1	DF606	W	FLW	FLS	FD291	DF607	W	WLL	
450 XC	450	06		FD138	1	DF606	W	FLW	FLS	FD291	DF607	W	WLL	
450 XC SIX DAYS	450	10		FD138	1	DF606	W	FLW	FLS	FD291	DF607	W	WLL	KG606
500 EXC	500	14		FD138	1	DF606	W	FLW	FLS	FD291	DF607	W	WLL	KG606
500 EXC - F / SIX DAYS	500	19		FD138	1	DF606	W	FLW	FLS	FD291	DF607	W	WLL	KG606
500 MX	500	92		FD138	1	DF606	W	FLW	FLS	FD075	DF607	W	WLL	
500 SX	500	93		FD138	1	DF606	W	FLW	FLS	FD075	DF607	W	WLL	
505 SX	505	07		FD138	1	DF606	W	FLW	FLS	FD291	DF607	W	WLL	
525 EXC	525	03	03	FD138	1	DF606	W	FLW	FLS	FD165	DF607	W	WLL	
525 EXC	525	04		FD138	1	DF606	W	FLW	FLS	FD291	DF607	W	WLL	
525 MXC	525	04		FD138	1	DF606	W	FLW	FLS	FD291	DF607	W	WLL	
525 SX	525	03	03	FD138	1	DF606	W	FLW	FLS	FD165	DF607	W	WLL	
525 SX	525	04		FD138	1	DF606	W	FLW	FLS	FD291	DF607	W	WLL	
530 EXC - R	530	08		FD138	1	DF606	W	FLW	FLS	FD291	DF607	W	WLL	KG606
530 XC / W	530	08		FD138	1	DF606	W	FLW	FLS	FD291	DF607	W	WLL	KG606

APPLICATIONS
 PADS FD
 DISCS DF
 SHOES MF
 LINES FK
 BRACKETS SP
 KITS KG
 CROSS REFERENCE





APPLICATIONS

PADS FD

DISCS DF

SHOES MF

LINES FK

BRACKETS SP

KITS KG

CROSS REFERENCE

BRAND & MODEL * MARCA Y MODELO MARCA E MODELLO * MARQUE ET MODÈLE	C.C.	YEAR	FRONT						REAR				KITS KG
			FD	N°	DF	OE	UPGRADE 1	UPGRADE 2	FD	DF	OE	UPGRADE	
continue KTM													
530 XC SIX DAYS	530	10	FD138	1	DF606	W	FLW	FLS	FD291	DF607	W	WLL	KG606
540 SXC	540	99	FD138	1	DF606	W	FLW	FLS	FD165	DF607	W	WLL	
550 MG_XC	550	94	FD138	1	DF606	W	FLW	FLS	FD165	DF607	W	WLL	
560 SMR	560	07	FD304	1	DF672	FLW			FD291	DF607	W	WLL	
600 4T GARA	600	91	FD128	1	DF606	W	FLW	FLS	FD075	DF607	W	WLL	
600 4T GS	600	93	FD138	1	DF606	W	FLW	FLS	FD075	DF607	W	WLL	
600 4T GS	600	94	FD138	1	DF606	W	FLW	FLS	FD165	DF607	W	WLL	
600 MX LC4	600	90	FD075	1	DF606	W	FLW	FLS	FD075	DF607	W	WLL	
620 DUKE	620	95	FD068	1					FD165	DF607	W	WLL	
620 LC4 EXC, EGS, SX	620	94	FD138	1	DF672	FLW			FD165	DF607	W	WLL	
625 EXC	625	03	FD138	1	DF606	W	FLW	FLS	FD165	DF607	W	WLL	
625 SMC	625	06	FD176	1					FD165	DF607	W	WLL	
640 LC4 ADVENTURE R	640	99	FD138	1	DF672	FLW			FD165	DF607	W	WLL	
640 LC4 ADVENTURE R	640	06	FD138	2	DF672	FLW			FD165	DF607	W	WLL	
640 DUKE	640	99	FD176	1					FD165				
640 LC4 SUPERMOTARD	640	02	FD068	1					FD165	DF607	W	WLL	
640 LC4 SUPERMOTARD (DF606SM)	640	05	FD176	1	DF606				FD165	DF607	W	WLL	
640 LC4 ENDURO	640	99	FD138	1	DF672	FLW			FD165	DF607	W	WLL	
660 SMC SUPERMOTARD	660	99	FD068	1					FD165				
660 SMC SUPERMOTARD	660	99	FD176	1					FD165				
690 DUKE	690	08	FD262	1	DF783	CW	CRW		FD165	DF798	W		
690 DUKE III R	690	10	FD262	1	DF783	CW	CRW		FD165	DF798	W		
690 DUKE	690	12	FD176	1	DF787	CW	CRW		FD165	DF798	W		
690 DUKE R	690	13	FD373	1	DF787	CW			FD165	DF798	W		
690 ENDURO	690	08	FD172	1	DF770	W	FLW		FD165	DF771	W		
690 ENDURO R	690	09	FD172	1	DF770	W	FLW		FD165	DF771	W		
690 SM	690	07	FD176	1	DF846	CW	FLW		FD165	DF782	FLW		
690 SM /PRESTIGE	690	07	FD262	1	DF660	CW	CRW		FD165	DF771	W		
690 SMC	690	08	FD262	1	DF846	FLWB			FD165	DF782	FLW		
690 SMC R	690	13	FD262	1	DF846	FLWB			FD165	DF771	W		
690 SMC R ABS	690	13	FD262	1	DF846	FLW			FD165	DF771	W		
690 SMC R ABS	690	16	FD262	1	DF846	FLW			FD165	DF782	FLW		
690 SMR	690	07	FD262	1	DF846	CW	CRW	FLW	FD165	DF798	W		
790 ADVENTURE /R	790	19	FD176	2	DF943	FLW			FD138	DF944	W	FLW	
790 ADVENTURE RALLY	790	20	FD176	2	DF943	FLW			FD138	DF944	W	FLW	
790 DUKE	790	18	FD176	2	DF801	CW			FD165	DF806	W		
890 DUKE R	890	20	FD373	2	DF787	CW			FD165	DF806	W		
950 ADVENTURE S	950	03	FD172	2	DF672	FLW			FD138	DF703	W		
950 R SUPER ENDURO	950	06	FD172	1	DF770	W	FLW		FD138				
950 SUPERMOTO R	950	07	FD262	2	DF783	CW	CRW		FD138	DF782	FLW		
LC8 990 DUKE	950	03	FD262	2	DF660	CW	CRW		FD165				
SUPERMOTO 950	950	05	FD262	2					FD138	DF786	FLW		
SUPER DUKE	950	05	FD262	2	DF783	CW	CRW		FD165				
990 ADVENTURE R	990	09	FD172	2	DF672	FLW			FD138	DF782	FLW		
990 ADVENTURE / S	990	06	FD172	2	DF770	W	FLW		FD138	DF782	FLW		
990 ADVENTURE / S ABS	990	06	FD172	2	DF770	W	FLW		FD138	DF782	FLW		
990 SM R	990	09	FD373	2					FD138	DF786	FLW		
990 SM T	990	09	FD262	2					FD138	DF786	FLW		
990 SM T ABS	990	11	FD262	2					FD138	DF786	FLW		
990 SUPER DUKE	990	06	FD262	2	DF883	CW			FD165	DF786	FLW		
990 SUPERMOTO / R	990	07	FD262	2					FD138	DF786	FLW		
990 SUPERMOTO / R	990	12	FD373	2	DF783	CW			FD138	DF786	FLW		
990 R SUPER ENDURO	990	06	FD172	1	DF770	W	FLW		FD138	DF782	FLW		
1050 ADVENTURE	1050	15	FD176	2	DF783	CW	CRW		FD138	DF793	FLW		
1190 ADVENTURE	1190	13	FD176	2	DF785	CW	CRW		FD138	DF793	FLW		
1190 ADVENTURE R	1190	13	FD176	2	DF785	CW	CRW		FD138	DF793	FLW		
RC 8	1190	08	FD373	2	DF783	CW	CRW		FD220	DF784	W	FLW	
RC 8 R	1190	09	FD373	2	DF783	CW	CRW		FD220	DF784	W	FLW	
1290 SUPER ADVENTURE	1290	15	FD176	2	DF785	CW	CRW		FD138	DF793	FLW		
1290 SUPER DUKE GT	1290	16	FD373	2	DF843	CW			FD220	DF788	W		
1290 SUPER DUKE R	1290	13	FD373	2	DF843	CW			FD220	DF788	W		
KTM 4 Wheels													
450 SX	450	08	FD407	2					FD408				
450 XC	450	08	FD407	2					FD408				
505 SX	505	08	FD407	2					FD408				
525 XC	525	08	FD407	2					FD408				
KYMCO													
50 SNIPER	50	94	FD166	1	DF018				MF002	-			
ACTIV 50	50	04	FD145	1					MF	-			
ACTIV SR 50	50	08	FD073	1					MF	-			
AGILITY 50	50	05	FD187	1					MF740	-			
AGILITY CARRY 50	50	14	FD261	1	DF878	W			MF	-			



BRAND & MODEL · MARCA Y MODELO MARCA E MODELLO · MARQUE ET MODÉLE	C.C.	YEAR	FRONT					REAR				KITS KG
			FD _{MF}	N°	DF	OE	UPGRADE 1	UPGRADE 2	FD _{MF}	DF	OE	
continue KYMCO												
AGILITY RS 50	50	09	FD187	1					MF740	-		
BET & WIN 50	50	01	FD145	1					FD145			
CURIO CX	50	94	FD166	1	DF018				MF002	-		
DINK 50	50	00	FD145	1	DF878	W			MF	-		
FEVER ZX 50	50	97	FD144	1					MF001	-		
FILLY 50	50	00	FD144	1	DF018				MF002	-		
FILLY 50 ELEGANCE	50	03	FD187	1	DF878	W			MF002	-		
GRAND DINK 50	50	04	FD145	1	DF508	W			MF	-		
HEROISM 50	50	95	FD175	1	DF018				MF002	-		
JETIX	50	09	FD073	1					FD145			
K - PIPE	50	12	FD117	1					MF	-		
KB 50	50	95	FD144	1	DF018				MF002	-		
KYMCOSENTO 50	50	13	FD145	1					MF002	-		
LIKE	50	09	16	FD187	1	DF411	W		MF	-		
LIKE	50	17	FD439	1	DF411	W			FD438			
NEWSENTO 50	50	13	FD145	1					MF002	-		
NEXXON 50	50	07	08	FD063	1				FD145			
NEXXON 50	50	09	FD073	1					FD073			
PEOPLE	50	99	04	FD261	1	DF414	W		MF740	-		
SCOUT 50	50	99	FD144	1					MF002	-		
SOONER	50	03	FD144	1					MF	-		
SUPER 8 2T	50	14	FD261	1					MF	-		
SUPER 8 4T	50	14	FD261	1					MF	-		
SUPER 9	50	00	FD145	1					FD261			
TB 50 OFF	50	99	FD144	1					MF	-		
TOP BOY 50	50	97	FD144	1	DF018				MF	-		
VISA R	50	11	FD075	1					MF002	-		
VITALITY 2T	50	04	FD187	1					MF	-		
VITALITY 4T	50	05	FD187	1					MF	-		
YAGER	50	07	FD145	1					MF	-		
YUP	50	02	03	FD144	1	DF878	W		MF	-		
YUP	50	04	FD187	1					MF	-		
ZX 50	50	99	FD144	1	DF878	W			MF	-		
TOP BOY 100	100	98	FD144	1	DF878	W			MF	-		
ACTIV 110	110	04	FD145	1					MF	-		
AXR 110	110	04	FD145	1					MF	-		
VISA R	110	11	FD075	1					MF002	-		
125 FREEWY	125	94	FD166	1					MF	-		
ACTIV 125	125	04	FD145	1					MF	-		
AGILITY 125	125	06	08	FD187	1				MF740	-		
AGILITY CARRY 125	125	19	FD439	1					FD145			
AGILITY CITY 125	125	09	17	FD261	1	DF412	W		FD075			
AGILITY CITY 125	125	18	FD439	1	DF412	W			FD145			
AGILITY RS 125	125	09	FD187	1					MF740	-		
BET & WIN 125	125	00	FD145	1					FD145			
DINK 125	125	97	FD145	1	DF878	W			FD145	DF878	W	
DOWNTOWN	125	09	14	FD266	1				FD438			
DOWNTOWN	125	15	FD245	1					FD438	DF307	W	
GRAND DINK 125	125	02	FD145	1	DF508	W			FD145			
GS 125i	125	10	FD399	1					FD399			
HEROISM	125	95	FD175	1	DF018				MF002	-		
HIPSER 125	125	00	FD145	1					MF	-		
JETIX	125	10	FD073	1					FD145			
K-PIPE	125	12	FD117	1					MF	-		
K-XCT	125	13	14	FD266	1				FD474			
K-XCT	125	15	FD245	1					FD474			
LIKE	125	09	16	FD187	1	DF411	W		FD145			
LIKE	125	17	FD439	1	DF411	W			FD438			
MILLER	125	19	FD439	1					FD438			
MOVIE	125	97	08	FD145	1				MF740	-		
MOVIE 125 S i	125	09	FD399	1	DF508	W			MF740	-		
NEW DOWNTOWN	125	16	FD245	1					FD438	DF307	W	
NEXXON 125	125	07	08	FD063	1				FD145			
NEXXON 125	125	09	FD073	1					FD073			
PEOPLE	125	99	16	FD261	1	DF412	W		MF740	-		
PEOPLE	125	17	FD187	1	DF412	W			FD438			
PEOPLE GTI 125	125	10	11	FD245	1	DF412	W		FD399			
PEOPLE GTI 125	125	12	11	FD245	1	DF412	W		FD438			
PEOPLE S	125	19	FD187	1	DF412	W			FD438			
QUANNON 125	125	07	FD145	1					FD145			
QUANNON NAKED 125	125	09	FD145	1					FD145			
SPIKE	125	04	FD145	1					FD145			

APPLICATIONS

PADS FD

DISCS DF

SHOES MF

LINES FK

BRACKETS SP

KITS KG

CROSS REFERENCE





APPLICATIONS

PADS FD

DISCS DF

SHOES MF

LINES FK

BRACKETS SP

KITS KG

CROSS REFERENCE

BRAND & MODEL * MARCA Y MODELO MARCA E MODELLO * MARQUE ET MODÈLE	C.C.	YEAR	FRONT						REAR				KITS KG	
			FD _{MF}	N°	DF	OE	UPGRADE 1	UPGRADE 2	FD _{MF}	DF	OE	UPGRADE		
continue KYMCO														
STRAIGHT 125	125	05	06	FD145	1						MF	-		
STRAIGHT 125	125	07		FD063	1						FD145			
STRYKER 125	125	99		FD187	1						MF	-		
SUPER 8	125	14		FD261	1						MF	-		
SUPER 9	125	00		FD145	1						FD261			
SUPER DINK 125i	125	09	17	FD266	1						FD438			
SUPER DINK 125i	125	18		FD541	1						FD474			
VIVIO 125	125	99		FD187	1						MF740	-		
X TOWN	125	16		FD245	1						FD438			
YAGER 125	125	07	08	FD145	1						FD145			
YAGER GT 125	125	09	12	FD145	1						FD145			
YAGER GT 125	125	13		FD266	1						FD438			
ZING	125	00		FD145	1						MF	-		
BET & WIN 150	150	00		FD145	1						FD145			
CUSTOM DX 150	150	94		FD073	1						MF	-		
DINK 150	150	97		FD145	1	DF878	W				FD145	DF878	W	
HEROISM	150	94		FD175	1	DF018					MF	-		
HIPSER 150	150	00		FD145	1						MF	-		
JETIX	150	10		FD073	1						FD145			
LIKE	150	17		FD439	1	DF411	W				FD438			
MINI BIKE 150	150	14		FD145	1						MF	-		
MOVIE XL 150	150	01		FD187	1	DF508	W				MF740	-		
NSR 150	150	94		FD145	1						FD145			
PEOPLE	150	99	04	FD261	1	DF414	W				MF740	-		
PEOPLE S	150	17		FD187	1	DF412	W				FD438			
QUANNON 150	150	10		FD145	1						FD145			
STRAIGHT 150	150	05		FD145	1						FD145			
DOWNTOWN	200	10		FD266	1						FD438	DF307	W	
LIKE	200	09		FD187	1	DF411	W				FD145			
PEOPLE	200	05		FD261	1	DF412	W				MF740	-		
PEOPLE GTI	200	12		FD245	1	DF412	W				FD438	-		
YAGER GT 200 i	200	09		FD145	1						FD145			
BET & WIN 250	250	00		FD145	1	DF508	W				FD145			
GRAND DINK 250	250	01	01	FD145	1	DF508	W				FD145			
GRAND DINK 250	250	02		FD275	1	DF508	W				FD276			
PEOPLE	250	02	04	FD145	1	DF412	W				MF	-		
PEOPLE	250	05		FD145	1	DF412	W				FD474			
PEOPLE S DER./RIGHT	250	06		FD145	2	DF412	W							
PEOPLE S IZQ./LEFT	250	06		FD187	2	DF412	W				FD474			
SUPER 9	250	00		FD145	1						FD261			
VENOX STEEL	250	01		FD266	1						MF	-		
XCITING 250	250	05	05	FD266	1	DF410	W				FD474	DF413	W	
XCITING 250	250	06		FD266	2	DF410	W				FD474	DF413	W	
XCITING 250 R	250	08		FD266	2	DF410	W				FD266	DF413	W	
YUP 250	250	02		FD145	1	DF508	W				FD145			
AGILITY 300	300	19		FD399	1						FD438			
AGILITY MAXI	300	15		FD245	1						FD438			
DOWNTOWN	300	09	14	FD266	1						FD438			
K - XCT 300i	300	12		FD245	1	DF410	W				FD399	DF413	W	
PEOPLE 300 LEFT/IZQ.	300	08		FD187	2	DF412	W				FD214			
PEOPLE 300 RIGHT/DER.	300	08		FD145	2	DF412	W							
PEOPLE GT 300i	300	10		FD245	1	DF412	W				FD399			
SUPER DINK 300	300	10		FD266	1						FD438	DF307	W	
SUPER DINK 300 i ABS	300	11		FD266	1						FD438	DF307	W	
X TOWN	300	16		FD245	1						FD438	DF307	W	
XCITING 300i	300	08		FD266	2	DF410	W				FD474	DF413	W	
XCITING 300i R	300	08		FD266	2	DF410	W				FD474	DF413	W	
YAGER GT 300 i	300	13		FD266	1						FD438			
DOWNTOWN	350	15		FD245	1						FD399	DF307	W	
XCITING 400	400	12		FD367	2	DF415	FLW				FD266	DF413	W	
XCITING 400 S	400	18		FD367	2	DF415	FLW				FD266	DF413	W	
XCITING 500	500	04		FD266	2	DF410	W				FD266	DF413	W	
AK 550	550	17		FD475	2	DF415	FLW				FD526			
MYROAD 700	700	08		FD266	2						FD266			
KYMCO 4 Wheels														
Mxer 50	50	03		MF002		-					FD261			
MXU 50	50	06		MF		-					FD261			
MAXXER 90	90	05		MF		-					FD261			
Mxer 150	150	03		MF002		-					FD261			
MXU 150	150	06		MF		-					FD261			
MXU 150	150	05		MF		-					FD095			
KXR 250 SPORT	250	04		FD336	2	DF878	W				FD275	DF879	W	



BRAND & MODEL · MARCA Y MODELO MARCA E MODELLO · MARQUE ET MODÉLE	C.C.	YEAR	FRONT					REAR				KITS KG	
			FD _{MAT}	N°	DF	OE	UPGRADE 1	UPGRADE 2	FD _{MAT}	DF	OE		UPGRADE
continue KYMCO 4 Wheels													
MAXXER 250	250	06	FD336	2	DF878	W				FD275			
MXU 250	250	05	FD336	2	DF878	W				FD275	DF879	W	
URBAN QUAD 250	250	06	FD336	2	DF878	W				FD275	DF879	W	
MAXXER 300	300	06	FD336	2	DF878	W				FD275			
MXU 300	300	05	FD336	2	DF878	W				FD275	DF879	W	
MXU 300 R	300	10	FD336	2	DF878	W				FD336	DF879	W	
MAXXER 400	400	09	FD353	2						FD			
MXU 400	400	08	FD353	2						FD			
MAXXER 450	450	10	FD353	2						FD			
MXU 450 i IRS	450	11	12	FD353	2					FD			
MXU 450 i	450	13		FD353	2					FD			
MXU 500	500	06	FD336	2	DF878	W				FD336			
MXU 500 IRS	500	09	FD336	2	DF878	W				FD			
LANVERTTI													
NEON 125	125	06	FD095	1						MF	-		
LAMBRETTA													
PATO 50 N	50	09	FD073	1						FD073			
V 50 SPECIAL	50	20	FD188	1						FD200			
125 DL	125	14	MF766		-					MF766	-		
125 LI	125	14	MF765		-					MF765	-		
LN 125	125	12	FD188	1						MF	-		
PATO 125 N	125	09	FD073	1						FD073			
V 125 SPECIAL PIRELLI EDITION	125	19	FD188	1						FD200			
150 DL	150	14	MF766		-					MF766	-		
150 LI	150	14	MF765		-					MF765	-		
PATO 150 N	150	09	FD073	1						FD073			
175 LI	175	14	MF765		-					MF765	-		
175 TV II	175	14	MF765		-					MF765	-		
200 DL	200	14	MF766		-					MF766	-		
V 200	200	20	FD188	1						FD200			
G 325	325	20	FD117	1						FD117			
LAVERDA													
50 GAUCHO	50	90	FD012	1						FD012			
125 NAVARRO	125	90	FD089	1						FD012			
125 TOLEDO	125	90	FD089	1						MF	-		
650	650	92	FD068	2						FD012			
GHOST	650	96	97	FD068	2	DF660	CW	CRW		FD012	DF458	W	
SPORT	650	95	FD068	2	DF660	CW	CRW			FD012	DF458	W	
668 HIDALGO	668	90	FD075	2						FD075			
700 EL CID	700	90	FD075	2						FD075			
750 BLACK STRIKE	750	98	FD068	2	DF660	CW	CRW			FD012	DF458	W	
750 FORMULA	750	98	FD068	2	DF660	CW	CRW			FD012	DF458	W	
750 SUPER SPORT	750	00	FD068	2	DF660	CW	CRW			FD012	DF458	W	
SFC 1000	1000	03	FD262	2						FD220			
LAVERDA 4 Wheels													
QUASAR 125 HP	125	04	MF		-					FD302			
QUASAR 180 HP	180	04	MF		-					FD302			
QUASAR 400 4X4	400	04	FD302	2						FD302			
QUASAR 500 4X4	500	04	FD302	2						FD302			
LML													
STAR 2T (TODAS)	125	10	FD152	1	DF362	W				MF	-		
STAR 4T (TODAS)	125	10	FD152	1	DF362	W				MF	-		
STAR BICOLOR VINTAGE 4T	125	10	FD152	1	DF362	W				MF	-		
STAR GT 2T	125	10	FD152	1	DF362	W				MF	-		
STAR GT 4T	125	10	FD152	1	DF362	W				MF	-		
STAR MAT SERIES 4T	125	10	FD152	1	DF362	W				MF	-		
STAR RS 4T	125	10	FD152	1	DF362	W				MF	-		
STAR 2T (TODAS)	150	10	FD152	1	DF362	W				MF	-		
STAR GT 2T	150	10	FD152	1	DF362	W				MF	-		
STAR 4T (TODAS)	151	10	FD152	1	DF362	W				MF	-		
STAR BICOLOR VINTAGE 4T	151	10	FD152	1	DF362	W				MF	-		
STAR GT 4T	151	10	FD152	1	DF362	W				MF	-		
STAR MAT SERIES 4T	151	10	FD152	1	DF362	W				MF	-		
STAR RS 4T	151	10	FD152	1	DF362	W				MF	-		
STAR CORSA 4T	165	10	FD152	1	DF362	W				MF	-		
STAR 4T (TODAS)	200	12	FD152	1	DF362	W				MF	-		
STAR ART (TODAS)	200	12	FD152	1	DF362	W				MF	-		
STAR GT (TODAS)	200	12	FD152	1	DF362	W				MF	-		
STAR OFF ROAD	200	12	FD200	1	DF362	W				MF	-		
STAR RS/SPORT	200	12	FD152	1	DF362	W				MF	-		
STAR URBAN (TODAS)	200	12	FD152	1	DF362	W				MF	-		
LIFAN COLOMBIA													



APPLICATIONS
 PADS FD
 DISCS DF
 SHOES MF
 LINES FK
 BRACKETS SP
 KITS KG
 CROSS REFERENCE



APPLICATIONS

PADS FD

DISCS DF

SHOES MF

LINES FK

BRACKETS SP

KITS KG

CROSS REFERENCE

C.C.	YEAR	FRONT						REAR				KITS		
		FD	N°	DF	OE	UPGRADE 1	UPGRADE 2	FD	DF	OE	UPGRADE			
continue LIFAN COLOMBIA												KG		
OLF 110-16	110			FD214	1					FD073				
110 F	110			FD214	1					MF	-			
LF 125-5	125			FD073	1					MF	-			
LF 125-3	125			FD095	1					MF	-			
LF 150 GY 3A	150			FD117	1					FD117				
LF 200 GY 2	200			FD117	1					FD117				
LF 200 III SBK	200			FD169	1					MF	-			
LF 250 V2	250			FD169	1					MF	-			
LINHAI														
MONARCH	160	04		FD169	1	DF458	W			FD214	DF484	W		
MAIN STR. 260	260	04		FD169	1	DF458	W			FD214	DF484	W		
LINHAI 4 Wheels														
GOON 260	260	07		FD	2					FD301				
LONCIN														
LX 110	110	02		FD145	1					MF	-			
LX 125	125	02		FD145	1					MF	-			
LX 150	150	02		FD169	1					MF	-			
MACBOR														
565	50	04		FD224	1					FD065				
510 RACING	50	04		FD224	1					FD065				
512 RACING	50	04		FD224	1					FD065				
515 RACING	50	04		FD224	1					FD065				
CX 50	50	05		MF		-				FD075				
CX 250 / R	250	05		MF		-				FD187				
ZX 250	250	06		FD303	2					FD303				
MAGURA														
4 PADS CALIPER SM		07		FD304										
MALAGUTI														
50 CENTRO SL	50	94		FD152	1	DF650	W	RW		MF630	-			
50 CUSTOM FOX	50	93		FD071	1					MF	-			
50 F10	50	96		FD153	1	DF642	W			MF630	-			
50 MGX	50	94		FD135	1					MF	-			
50 RST	50	90		FD071	1					FD071				
CIAK	50	99		FD153	1					FD200				
CROSSER 50	50	99		FD071	1	DF649	W			MF	-			
DRAGON NKD	50	05		FD220	1					FD065				
F 15 FIRE FOX	50	96	97	FD071	1	DF649	W			MF630	-			
F 15 FIRE FOX LC	50	98		FD084	1					FD152	DF649	W		
F10	50	91		FD135	1	DF642	W			MF630	-			
F12 PHANTOM AIRE/AGUA 50	50	94	97	FD071	1	DF649	W			MF002	-			
F12 PHANTOM	50	98		FD084	1	DF649	W			MF002	-			
YESTERDAY 50	50	98		FD153	1	DF642	W			MF	-			
XSM	50	05		FD162	1					FD065				
XTM	50	04		FD065	1					FD065				
80 DUNE	80	93		FD074	1					MF	-			
80 F10	80	92		FD135	1					MF	-			
CIAK	100	99		FD153	1					FD153				
F12 PHANTOM	100	00		FD153	1					FD153	DF649	W		
125 RUNNER RALLY	125	93		FD074	1					MF712	-			
CIAK	125	03		FD153	1					FD153				
F 18 WARRIOR	125	00	03	FD153	1					FD228	DF649	W		
MADISON 125	125	99	05	FD162	1	DF622	W			FD228				
MADISON 125 R 125	125	06	06	FD074	1					FD228				
MADISON 3 125	125	07		FD162	1					FD220				
MONTE PRO	125	20		FD086	1					FD075				
PHANTOM MAX 125	125	04		FD162	1	DF622	W			FD220	DF622	W		
X SM 125	125	19		FD086	1					FD075				
XTM 125	125	19		FD086	1					FD075				
CIAK	150	03		FD153	1					FD153				
F 18 WARRIOR	150	00	03	FD153	1					FD228	DF649	W		
MADISON 150	150	00		FD162	1	DF622	W			FD228	DF622	W		
MADISON 180	180	02		FD138	1	DF622	W			FD220	DF622	W		
MADISON 200	200	04		FD138	1	DF622	W			FD220	DF622	W		
PHANTOM MAX 200	200	04		FD162	1	DF622	W			FD220	DF622	W		
MADISON 250	250	99	05	FD245	1	DF621	W			FD228	DF622	W		
MADISON RS 250	250	06	06	FD074	1					FD228	DF622	W		
MADISON 3 250 i.e.	250	07		FD162	1					FD220				
PASSWORD 250	250	05	06	FD074	1					FD228	DF621			
PASSWORD 250	250	07		FD162	1					FD228				
PHANTOM MAX 250	250	05		FD162	1	DF622	W			FD228	DF622	W		
MADISON 400	400	01	05	FD245	1	DF621	W			FD228	DF621			
MADISON K 400	400	06		FD245	1					FD228	DF621			



BRAND & MODEL · MARCA Y MODELO MARCA E MODELLO · MARQUE ET MODÉLE	C.C.	YEAR	FRONT					REAR				KITS KG
			FD MF	N°	DF	OE	UPGRADE 1	UPGRADE 2	FD MF	DF	OE	
continue MALAGUTI												
SPIDER MAX GT 500	500	04	FD074	2					FD228			
MASAI 4 Wheels												
L 50	50	05	MF		-				FD075			
L 100	100	05	MF		-				FD075			
L 150	150	05	MF		-				FD075			
A 300 QUAD	300	05	FD094	2					FD275			
A 450 QUAD	450	05	FD094	2					FD275			
MASH												
BIBOP	50	14	FD175	1					MF			
BIBOP RACING	50	14	FD175	1					MF			
CITY 50	50	18	FD073	1					FD073			
DIRT TRACK	50	18	FD252	1					MF			
FIFTY	50	18	FD252	1					MF			
CAFÉ RACER	125	14	FD544	1					FD095			
CITY	125	18	FD073	1					FD073			
SCRAMBLER	125	14	FD252	1					MF			
SEVENTY	125	14	FD252	1					MF			
SEVENTY FIVE	125	14	FD544	1					FD095			
BLACK SEVEN	250	17	FD073	1					FD095			
CAFÉ RACER	250	14	FD544	1					FD095			
TWO FIFTY	250	14	FD544	1					MF			
ROADSTAR	400	14	FD266	1					MF			
SCRAMBLER	400	17	FD266	1					MF			
TT 40	400	17	FD068	1					MF			
MBK MOTOBKANE												
BOOSTER N.G.	50	99	FD153	1	DF473	W	RW	WS	MF750	-		
BOOSTER NAKED	50	06	FD153	1	DF473	W	RW	WS	MF750	-		KG473
BOOSTER SPIRIT	50	98	FD153	1	DF473	W	RW	WS	MF750	-		
BOOSTER WHEEL 12"	50	06	FD153	1	DF473	W	RW	WS	MF750	-		KG473
BOOSTER-R	50	94	FD153	1	DF473	W	RW	WS	MF750	-		
EVOLIS	50	92	FD153	1	DF466	W			MF458	-		
FIZZ	50	94	FD153	1	DF466	W			MF453	-		
FLIPPER	50	99	FD153	1	DF015	W			MF	-		
MACH G/R	50	02	FD171	1	DF629	W	RW	FLS	MF	-		
NITRO	50	97	FD171	1	DF037	W	RW	FLS	FD206	DF037	W	RW
OVETTO	50	98	FD153	1	DF629	W	RW	FLS	MF458	-		
STUNT	50	00	FD206	1	DF037	W	RW	FLS	MF	-		
TARGET	50	92	FD136	1	DF466	W			MF458	-		
X-LIMIT	50	04	FD162	1					FD065			
X-POWER	50	99	02	FD117	1	DF470	W		FD079			
X-POWER	50	03	FD162	1					FD065			
BOOSTER	100	99	99	FD153	1	DF473	W	RW	WS	MF750	-	
BOOSTER	100	00	FD136	1					MF640	-		
CITYLINER	125	09	FD355	1					FD220			
DOODO	125	00	FD153	1	DF492	W			MF640	-		
FLAME	125	00	03	FD079	1				MF458	-		
FLAME X	125	04	FD342	1					MF458	-		
SKYCRUISER	125	06	09	FD355	1	DF500	W		FD220	DF524	W	KG500
SKYCRUISER	125	10	FD140	1	DF500	W			FD220	DF524	W	
SKYCRUISER ABS	125	11	FD140	1	DF500	W			FD214	DF524	W	
SKYLINER	125	99	00	FD138	1	DF492	W		MF640	-		
SKYLINER	125	01	FD138	1	DF492	W			FD220	DF369	W	
THUNDER	125	01	FD138	1					FD220			
X - OVER	125	10	FD473	1					MF458	-		
DOODO	150	01	FD153	1	DF492	W			MF640	-		
SKYLINER	150	01	FD138	1	DF492	W			FD220	DF369	W	
THUNDER	150	01	FD138	1					FD220			
SKYLINER	180	03	FD138	1	DF492	W			FD220	DF369	W	
SKYLINER	250	00	FD169	1	DF458	W			FD214			
KILIBRE	300	03	FD138	1					FD138			
SKYLINER	400	04	FD142	1	DF500	W			FD352	DF501	W	
MECATECNO												
50 ALEVIN	50	94	FD065	1					MF	-		
50 RACING CR-7	50	93	FD065	1					MF	-		
50 RACING CR-8	50	93	FD065	1					MF	-		
75 CR	75	91	FD065	1					MF	-		
METRAKIT												
BIG FOOT	50	08	FD265	1					FD230			
FUN 2 STROKE	50	05	FD065	1					FD224			
FUN 4 STROKE	50	05	FD065	1					FD224			
MINI GP	50	03	FD065	1					FD224			
MINI GP 50 R	50	08	FD360	1					FD224			

APPLICATIONS
 PADS FD
 DISCS DF
 SHOES MF
 LINES FK
 BRACKETS SP
 KITS KG
 CROSS REFERENCE





APPLICATIONS

PADS FD

DISCS DF

SHOES MF

LINES FK

BRACKETS SP

KITS KG

CROSS REFERENCE

BRAND & MODEL * MARCA Y MODELO MARCA E MODELLO * MARQUE ET MODÈLE	C.C.	YEAR	FRONT					REAR				KITS KG	
			FD _{MF}	N°	DF	OE	UPGRADE 1	UPGRADE 2	FD _{MF}	DF	OE		UPGRADE
continue METRAKIT													
MINI GP XL	50	05	FD220	1						FD224			
MONGOOSE	50	08	FD265	1						FD230			
PRO	50	08	FD265	1						FD230			
MINI GP 70 R	70	08	FD360	1						FD224			
MINI GP SP 70	70	08	FD200	1						FD224			
MINI GP XL 80 PRO	80	04	FD223	1						FD224			
MINI GP XL 80 R	80	08	FD341	1						FD224			
XL 08	80	08	FD360	1						FD224			
SRM 110 4T	110	07	FD265	1	DF688	W				FD230	DF689	W	
PRE GP 125	125	07	FD341	1						FD224			
METRAKIT 4 Wheels													
QUARK 50	50	05	MF		-					FD075			
QUARK 100	100	05	MF		-					FD075			
MINELLI													
OMEGA 125	125	06	FD169	1						FD214			
OMEGA 250	250	06	FD169	1						FD214			
MODENAS													
KRISS 115	115	99	FD145	1						MF	-		
MONDIAL													
EVO	1000	03	FD262	2	DF660	CW	CRW			FD220			
NUDA	1000	03	FD262	2	DF660	CW	CRW			FD220			
PIEGA 1000	1000	03	FD262	2	DF660	CW	CRW			FD220			
MONKEY BIKE													
MB 50 D	50	06	FD136	1	DF466	W				MF	-		
MB 50 G	50	06	FD136	1	DF466	W				MF	-		
MB 50 R	50	06	FD136	1	DF466	W				MF	-		
MB 90 R	90	06	FD136	1	DF466	W				MF	-		
MB 110 D	110	06	FD136	1	DF466	W				MF	-		
MB 110 G	110	06	FD136	1	DF466	W				MF	-		
MB 110 M	110	06	FD136	1	DF466	W				MF	-		
MB 125 SM	125	06	FD162	1						FD065			
MB 125 TR	125	06	FD162	1						FD065			
MB OCTOPUS 125	125	06	FD095	1						MF	-		
MB 200 SM	200	06	FD162	1						FD065			
MB 200 TR	200	06	FD162	1						FD065			
MONTESA													
COTA 4 RT	250	05	11	FD223	1	DF086	W			FD224	DF809	W	
COTA 4 RT	250	12		FD446	1	DF086	W			FD224	DF809	W	
4 RIDE	260	16	17	FD460	1	DF086	W			FD224	DF087	W	
4 RIDE	260	18		FD511	1	DF086	W			FD224	DF087	W	
COTA 260 4RT	260	15	17	FD223	1	DF086	W			FD224	DF809	W	
COTA 260 4RT	260	18		FD511	1	DF086	W			FD224	DF809	W	
COTA 260 4RT RACE REPLICA	260	15	17	FD460	1	DF086	W			FD224	DF809	W	
COTA 300 RR	300	15	17	FD460	1	DF086	W			FD224	DF809	W	
COTA 300 RR	300	18		FD511	1	DF086	W			FD224	DF809	W	
COTA 310	310	90		FD122	1					FD123			
COTA 311 EVASION	311	91		FD122	1					FD123			
COTA 314 R	314	94		FD122	1					FD123			
COTA 315 R	315	99		FD122	1					FD123			
COTA 315 R	315	01		FD238	1	DF086	W			FD224	DF809	W	
MOTO GUZZI													
125 BX	125	92		FD012	1					FD012			
125 C	125	92		FD012	1					MF	-		
350 NEVADA	350	92		FD012	1					FD012			
350 TRENTACINQUE GT	350	92		FD012	1					FD012			
V 35 FLORIDA III	350	92		FD012	1					FD012			
750 BREVA i.e.	750	03		FD176	1	DF660	CW	CRW		FD012			
750 NEVADA	750	92		FD012	1					FD012			
750 NEVADA CLUB	750	98		FD012	1					FD012			
750 SP	750	92		FD012	2					FD012			
NEVADA 750 AQUILA NERA	750	10		FD176	1	DF660	CW	CRW		FD220			
STR V 750 ie	750	03		FD176	1	DF660	CW	CRW		FD220			
V 7 CLASSIC	750	08		FD176	1	DF660	CW	CRW		FD012			
V 7 CLASSIC CAFÉ	750	09		FD176	1	DF660	CW	CRW		FD220			
V 7 III	750	17		FD176	1	DF660	CW	CRW		FD220			
V 7 III CARBON	750	18		FD176	1	DF660	CW	CRW		FD220			
V 7 III MILANO	750	18		FD176	1	DF660	CW	CRW		FD220			
V 7 III ROUGH	750	18		FD176	1	DF660	CW	CRW		FD220			
V 7 RACER	750	11		FD176	1	DF660	CW	CRW		FD220			
V 7 SCRAMBLER	750	12		FD176	1	DF660	CW	CRW		FD220			
GRISO 850 8V	850	06	08	FD176	2	DF660	CW	CRW		FD220	DF955	W	
GRISO 850 8V SE SPECIAL EDITION	850	09		FD176	2	DF660	CW	CRW		FD220	DF955	W	



BRAND & MODEL · MARCA Y MODELO MARCA E MODELLO · MARQUE ET MODÈLE	C.C.	YEAR	FRONT					REAR				KITS KG	
			FD _{MF}	N°	DF	OE	UPGRADE 1	UPGRADE 2	FD _{MF}	DF	OE		UPGRADE
continue MOTO GUZZI													
STR BREVA 850	850	06	FD176	2	DF660	CW	CRW			FD220	DF955	W	
V 85 TT	850	19	FD176	2	DF660	CW	CRW			FD074			
V9 BOBBER	850	17	FD176	1	DF660	CW	CRW			FD220			
V9 ROAMER	850	17	FD176	1	DF660	CW	CRW			FD220			
940 CUSTOM	940	07	FD176	2	DF660	CW	CRW			FD138			
BELLAGIO AQUILA NERA	940	10	FD172	2	DF660	CW	CRW			FD138	DF955	W	
1000 CALIFORNIA III C.I./I.E	1000	92	FD013	2						FD013			
1000 SP III i.e.	1000	92	FD013	2						FD013			
CALIFORNIA AQUILA NERA	1000	10	FD176	2	DF660	CW	CRW			FD220	DF855	W	
CALIFORNIA SPECIAL SPORT	1000	03	FD176	2	DF660	CW	CRW			FD138	DF855	W	
CALIFORNIA STONE	1000	03	FD176	1	DF660	CW	CRW			FD138	DF855	W	
CENTAURO	1000	96	FD068	2	DF660	CW	CRW			FD012			
DAYTONA i.e	1000	91	94	FD068	2	DF472	FLW	FLV		FD012			
DAYTONA i.e	1000	95		FD068	2	DF660	CW	CRW		FD012	DF855	W	
EV STONE	1000	02		FD176	1	DF660	CW	CRW		FD220			
MGS/01 1000	1000	03		FD262	2	DF660	CW	CRW		FD220			
MILLE GT	1000	92		FD013	2					FD012			
QUOTA I.E	1000	91		FD098	2					FD089			
V11 SPORT BALLABIO	1000	03		FD176	2	DF660	CW	CRW		FD220			
1100 I CALIFORNIA	1100	94		FD013	2					FD013			
1100 I CALIFORNIA	1100	95		FD068	2					FD013			
1100 SPORT	1100	95	97	FD068	2	DF660	CW	CRW		FD012			
BREVA 1100	1100	05		FD176	2	DF660	CW	CRW		FD138	DF955	W	
CALIFORNIA ESPECIAL	1100	99		FD068	2	DF660	CW	CRW		FD138	DF855	W	
CALIFORNIA EV	1100	97		FD068	2	DF660	CW	CRW		FD138	DF855	W	
CALIFORNIA JACKAL	1100	99		FD068	2	DF660	CW	CRW		FD138	DF855	W	
GRISO	1100	05		FD176	2	DF660	CW	CRW		FD220	DF955	W	
STR 1100	1100	04		FD176	2	DF660	CW	CRW		FD220			
V-10 CENTAURO SPORT	1100	99		FD068	2	DF660	CW	CRW		FD012	DF855	W	
V-11 LE MANS ROSSO CORSA	1100	03		FD176	2	DF660	CW	CRW		FD012	DF855	W	
V-11 SCURA	1100	03		FD176	2	DF660	CW	CRW		FD012	DF855	W	
V-11 SPORT / LE MANS	1100	99		FD176	2	DF660	CW	CRW		FD012	DF855	W	
STELVIO	1150	08	10	FD176	2	DF660	CW	CRW		FD138	DF855	W	
STELVIO TT	1150	09	10	FD176	2	DF660	CW	CRW		FD138	DF855	W	
NORGE 1200	1200	06		FD176	2	DF660	CW	CRW		FD138	DF855	W	
NORGE 1200 GT 8V	1200	11		FD176	2	DF660	CW	CRW		FD138	DF955	W	
SPORT 1200	1200	07	08	FD176	2	DF660	CW	CRW		FD138	DF955	W	
SPORT 1200 V4	1200	09		FD176	2	DF660	CW	CRW		FD138	DF955	W	
STELVIO	1200	11		FD176	2	DF660	CW	CRW		FD138	DF855	W	
STELVIO NTX	1200	11	11	FD176	2	DF660	CW	CRW		FD138	DF855	W	
STELVIO NTX	1200	12		FD262	2	DF660	CW	CRW		FD138	DF955	W	
V 12 LE MANS	1200	10		FD373	2	DF660	CW	CRW		FD138			
V 12 STRADA	1200	10		FD373	2	DF660	CW	CRW		FD138			
V 12 X	1200	10		FD373	2	DF660	CW	CRW		FD138			
AUDACE	1400	15		FD176	2	DF817	CW	CRW		FD138	DF955	W	
AUDACE CARBON	1400	17		FD176	2	DF817	CW	CRW		FD138	DF955	W	
CALIFORNIA CUSTOM	1400	13		FD176	2	DF817	CW	CRW		FD138	DF955	W	
CALIFORNIA TOURING	1400	13		FD176	2	DF817	CW	CRW		FD138	DF955	W	
EL DORADO	1400	15		FD176	2	DF817	CW	CRW		FD138	DF955	W	
MGX - 21	1400	20		FD176	2	DF817	CW	CRW		FD138	DF955	W	
MOTO MORINI													
400 S	400	95		FD012	1					FD012			
SEIEMMEZZO	650	20		FD266	2					FD138			
X - CAPE	650	20		FD266	2					FD138			
9,5	950	05		FD176	2	DF660	CW	CRW		FD220			
CORSARO 1200	1200	05		FD176	2	DF660	CW	CRW		FD220			
CORSARO AVIO 1200	1200	08		FD176	2	DF660	CW	CRW		FD220			
CORSARO ESPECIAL	1200	20		FD373	2					FD220			
CORSARO ZT	1200	20		FD373	2					FD220			
CORSARO ZZ	1200	18		FD373	2					FD220			
GRANFERRO	1200	10		FD373	2					FD138			
GRANPASSO	1200	08		FD172	2					FD138			
MILANO	1200	18		FD373	2					FD220			
MM3	1200	07		FD176	2	DF660	CW	CRW		FD220			
SCRAMBLER	1200	09	17	FD172	2					FD138			
SCRAMBLER	1200	18		FD373	2					FD220			
SUPER SCRAMBLER	1200	20		FD373	2					FD220			
MOTOM													
GYPSY	50	07		FD175	1					MF	-		
DOLCEVITA	125	07		FD175	1					FD073			
LAMBRETTA	125	08		FD175	1					MF	-		
TRANSCITY	125	07		FD169	1					FD073			

APPLICATIONS

PADS FD

DISCS DF

SHOES MF

LINES FK

BRACKETS SP

KITS KG

CROSS REFERENCE





APPLICATIONS

PADS FD

DISCS DF

SHOES MF

LINES FK

BRACKETS SP

KITS KG

CROSS REFERENCE

BRAND & MODEL * MARCA Y MODELO MARCA E MODELLO * MARQUE ET MODÈLE	C.C.	YEAR	FRONT					REAR				KITS KG	
			FD _{MF}	N°	DF	OE	UPGRADE 1	UPGRADE 2	FD _{MF}	DF	OE		UPGRADE
continue MOTOM													
DOLCEVITA	150	07	FD175	1						FD073			
TRANSCITY	150	07	FD169	1						FD073			
MOTORHISPANIA													
FURIA	50	99	FD065	1						FD065			
MH 10 50 LC	50	12	FD075	1	DF888	W				FD075	DF889	W	
MH 10 50 LC SM	50	12	FD075	1	DF888	W				FD075	DF861	W	
RX 50 R	50	08	FD341	1	DF860	W				FD252	DF861	W	
RX RACING	50	99	FD133	1						FD065			
RYZ ENDURO	50	99	FD065	1						FD065	DF675	W	
RYZ PRO ENDURO	50	09	FD133	1	DF674	W	FLW			FD065			
RYZ PRO SM	50	09	FD133	1	DF811	W				FD065			
RYZ SM	50	99	04 FD133	1	DF674	W	FLW			FD065	DF675	W	
RYZ SM	50	05	FD133	1	DF888	W				FD065			
TRAIL 50 LASER AIRE, AGUA	50	93	FD065	1						MF	-		
URBAN BIKE	50	04	FD133	1	DF811	W				FD065	DF861	W	
XR G-30	50	93	FD065	1						MF	-		
ARENA ENDURO	125	05	FD065	1						FD065			
ARENA MOTARD	125	05	FD133	1						FD065			
DUNA DUAL SPORT	125	09	FD162	1						FD065			
DUNA SPORT CITY	125	09	FD162	1						FD252			
KN 1 NAKED	125	10	FD341	1	DF860	W				FD252	DF861	W	
KN 2 NAKED	125	14	FD341	1	DF860	W				FD252	DF861	W	
MH 10 PRO 125 LC	125	12	FD162	1	DF888	W				FD075	DF889	W	
MH 10 PRO 125 LC SM	125	12	FD341	1	DF860	W				FD075	DF861	W	
MH 7 NAKED	125	07	FD341	1	DF860	W				FD252	DF861	W	
RX 125 R	125	08	FD341	1	DF860	W				FD252	DF861	W	
MOTRON													
GTO MAX, WF, R	50	94	FD071	1						MF	-		
RZ	50	94	FD135	1						MF	-		
XLE	50	94	FD084	1						MF	-		
MOTUS													
MST	1650	15	FD176	2	DF917	CW				FD220	DF897	W	
MST R	1650	15	FD176	2	DF917	CW				FD220	DF897	W	
MV AGUSTA													
BRUTALE 675	675	12	FD176	2	DF830	CW				FD220	DF831	W	
F3 675	675	11	FD176	2	DF830	CW				FD220	DF831	W	
F3 675 RS	675	17	FD373	2	DF830	CW				FD220	DF831	W	
F3 675 SERIE ORO	675	12	FD373	2						FD220	DF831	W	
BRUTALE AMERICA	750	06	FD384	2	DF765	CW				FD486	DF766	W	
BRUTALE CRC	750	06	FD384	2	DF765	CW				FD486	DF766	W	
BRUTALE MAMBA	750	06	FD384	2	DF765	CW				FD486	DF766	W	
BRUTALE S/ORO	750	02	FD384	2	DF765	CW				FD486	DF766	W	
F-4	750	99	FD384	2	DF765	CW				FD486	DF766	W	
B3 800 RR	800	17	FD176	2	DF830	CW				FD220	DF831	W	
BRUTALE 800	800	13	FD176	2	DF830	CW				FD220	DF831	W	
BRUTALE 800 RR	800	15	FD176	2	DF830	CW				FD220	DF831	W	
BRUTALE 800 RR SCS	800	20	FD176	2	DF830	CW				FD220	DF831	W	
DRAGSTER 800 RC	800	17	FD176	2	DF830	CW				FD220	DF831	W	
DRAGSTER 800 RR	800	15	FD176	2	DF830	CW				FD220	DF831	W	
DRAGSTER 800 RR SCS	800	20	FD176	2	DF830	CW				FD220	DF831	W	
F-3 800	800	16	FD373	2	DF830	CW				FD220	DF831	W	
F-3 800 RC	800	16	FD373	2	DF830	CW				FD220	DF831	W	
RIVALE 800	800	13	FD475	2	DF830	CW				FD220	DF831	W	
RVS#1	800	18	FD176	2	DF830	CW				FD220	DF831	W	
STRADALE 800	800	15	FD475	2	DF830	CW				FD220	DF831	W	
SUPERVELOCE 800 / SERIE ORO	800	20	FD373	2	DF830	CW				FD220			
TURISMO VELOCE	800	14	FD475	2	DF830	CW				FD220	DF831	W	
TURISMO VELOCE LUSSO	800	14	FD475	2	DF830	CW				FD220	DF831	W	
BRUTALE 910	910	06	FD384	2	DF765	CW				FD486	DF766	W	
BRUTALE 920	920	11	FD176	2	DF765	CW				FD486	DF766	W	
BRUTALE 989	1000	08	09 FD176	2	DF765	CW				FD486	DF766	W	
BRUTALE 990 R	1000	10	FD176	2	DF765	CW				FD486	DF766	W	
BRUTALE 1000 RR /SERIE ORO	1000	20	FD373	2	DF765	CW				FD220	DF766	W	
F-4 1000	1000	06	06 FD262	2						FD486	DF766	W	
F-4 1000	1000	07	FD373	2						FD486	DF766	W	
F-4 MAMBA	1000	06	FD384	2	DF765	CW				FD486	DF766	W	
F-4	1000	16	FD373	2						FD220	DF766	W	
F-4 LH44	1000	18	FD373	2						FD220	DF766	W	
F-4 RC	1000	16	FD373	2						FD220	DF766	W	
RUSH 1000	1000	20	FD373	2						FD220	DF831	W	
VELTRO 1	1000	06	FD384	2	DF765	CW				FD486	DF766	W	
B-4 RR BRUTALE	1078	16	FD373	2						FD486	DF766	W	



BRAND & MODEL · MARCA Y MODELO MARCA E MODELLO · MARQUE ET MODÈLE	C.C.	YEAR	FRONT					REAR				KITS KG	
			FD _{MF}	N°	DF	OE	UPGRADE 1	UPGRADE 2	FD _{MF}	DF	OE		UPGRADE
continue MV AGUSTA													
BRUTALE 1078	1078	08	FD373	2						FD486	DF766	W	
BRUTALE CORSA 1090	1078	14	FD373	2						FD486	DF766	W	
BRUTALE 1090	1078	13	FD176	2						FD486	DF766	W	
BRUTALE 1090 R	1078	10	12	FD373	2					FD486	DF766	W	
BRUTALE 1090 R	1078	13	FD176	2						FD486	DF766	W	
BRUTALE 1090 RR	1078	13	FD373	2						FD486	DF766	W	
F-4 312 RR	1078	08	FD373	2						FD486	DF766	W	
F-4 1078 RR	1078	08	09	FD373	2					FD486	DF766	W	
F-4 1090 RR	1078	10	11	FD373	2					FD486	DF766	W	
F-4 RR CORSA CORTA	1078	12	FD373	2						FD486	DF766	W	
MZ/MuZ													
MOSKITO	50	00	FD094	1						MF	-		
SAXON	500	93	FD044	1						MF	-		
SILVER STAR	500	93	FD044	1						MF	-		
SKORPION	500	94	FD121	1						FD170			
BAGHIRA	660	00	FD074	1						FD075			
MASTIFF	660	00	FD074	1						FD075			
1000 S	1000	01	FD176	2	DF660	CW	CRW			FD220			
NIU													
N	EL	18	FD298	1						FD165			
NORTON													
952 COMANDO	952	04	FD068	2						FD220			
COMMANDO 961 CAFE RACER	961	10	17	FD262	2	DF660	CW	CRW		FD220			
COMMANDO 961 CAFE RACER	961	18	FD475	2	DF660	CW	CRW			FD220			
COMMANDO 961 SE	961	10	FD068	2	DF660	CW	CRW			FD220			
COMMANDO 961 SF	961	13	FD262	2	DF660	CW	CRW			FD220			
COMMANDO 961 SPORT	961	10	17	FD176	2	DF660	CW	CRW		FD220			
COMMANDO 961 SPORT	961	18	FD475	2	DF660	CW	CRW			FD220			
DOMINATOR 961	961	18	FD475	2						FD220			
V4 RR	1200	18	FD373	2						FD220			
OSSA													
TR 125i	125	15	FD223	1	DF808	W				FD224	DF809	W	
TR 250i	250	15	FD223	1	DF808	W				FD224	DF809	W	
EXPLORER 280i	280	12	FD223	1	DF808	W				FD224	DF809	W	
TR 280i	280	10	FD223	1	DF808	W				FD224	DF809	W	
ENDURO 300i	300	12	FD138	1	DF635	FLW	FLS	FRS		FD291			
TR 300i	300	15	FD223	1	DF808	W				FD224	DF809	W	
TR 300i FACTORY R	300	15	FD460	1	DF808	W				FD224	DF809	W	
P.G.O.													
BIG MAX 50	50	95	FD136	1	DF466	W				MF	-		
COMET	50	92	FD094	1						MF	-		
G-MAX	50	05	FD188	1						MF	-		
GALAXY	50	93	FD094	1						MF	-		
LIBRA 50	50	09	FD188	1						MF	-		
LIGERO 50	50	08	FD188	1						MF	-		
MEGA FIFTY	50	99	FD094	1	DF466	W				MF	-		
PMS	50	99	FD188	1	DF037	W	RW	FLS		MF	-		
PMX	50	99	FD136	1	DF466	W				MF	-		
STAR	50	93	MF002		-					MF	-		
STAR 50	50	95	FD094	1						MF	-		
T-REX 50	50	99	FD188	1	DF037	W	RW	FLS		MF	-		
BIG MAX 80	80	95	FD136	1						MF	-		
STAR 80	80	95	FD094	1						MF	-		
BIG MAX 90	90	95	FD136	1						MF	-		
PMS	110	99	FD188	1	DF037	W	RW	FLS		MF	-		
T-REX 110	110	99	FD188	1	DF037	W	RW	FLS		MF	-		
G-MAX	125	05	FD068	1						FD145			
LIBRA 125	125	09	FD188	1						MF	-		
LIGERO 125	125	06	FD188	1						MF	-		
STAR 125	125	95	FD145	1						FD012			
T-REX 125 4-T	125	99	FD188	1	DF037	W	RW	FLS		MF	-		
G-MAX	150	05	FD068	1						FD145			
LIBRA 150	150	09	FD188	1						MF	-		
T-REX 150 4-T	150	01	FD188	1	DF037	W	RW	FLS		MF	-		
G-MAX	250	06	FD068	1						FD145			
P.G.O. 4 Wheels													
X-RIDER 50	50	03	MF		-					FD094			
X-RIDER 90	90	05	MF		-					FD094			
X-RIDER 110	110	05	MF		-					FD094			
X-RIDER 150	150	03	MF		-					FD094			
PETRONAS													
FP 1	1000	05	FD262	2						FD220			

APPLICATIONS

PADS FD

DISCS DF

SHOES MF

LINES FK

BRACKETS SP

KITS KG

CROSS REFERENCE





APPLICATIONS

PADS **FD**

DISCS **DF**

SHOES **MF**

LINES **FK**

BRACKETS **SP**

KITS **KG**

CROSS REFERENCE

BRAND & MODEL • MARCA Y MODELO MARCA E MODELLO • MARQUE ET MODÈLE	C.C.	YEAR	FRONT					REAR				KITS KG	
			FD	N°	DF	OE	UPGRADE 1	UPGRADE 2	FD	DF	OE		UPGRADE
PEUGEOT													
E-LUDIX	EL	20	FD094	1						MF			
E-SATELIS	EL	11	FD187	1						FD187			
E-VIVACITY	EL	10	FD187	1						MF002	-		
BUXY 50	50	94	FD153	1	DF649	W				MF002	-		
DJANGO HERITAGE	50	15	FD187	1						MF	-		
DJANGO EVASION	50	15	FD187	1						MF	-		
ELYSEO	50	98	FD065	1	DF649	W				MF002	-		
ELISTAR AVANTAGE 2	50	05	FD065	1						FD270			
ELISTAR TSDI	50	02	FD065	1						FD270			
FOX	50	95	FD065	1						MF760	-		
JET FORCE	50	03	FD065	1						FD065			
JET C TECH	50	11	FD065	1						FD065			
JET DARKSIDE	50	11	FD065	1						FD065			
JET ICEBLADE	50	11	FD065	1						FD065			
JET H2i	50	11	FD065	1						FD065			
KISBEE	50	10	FD094	1						MF	-		
LOOXOR	50	01	FD065	1						MF002	-		
LUDIX 50 ELEGANCE/SNAKE/TREND	50	04	FD065	1						MF002	-		
LXR 50	50	10	FD188	1						FD399			
METROPOLIS 50	50	91	MF002		-					MF	-		
NEW VIVACITY 50	50	08	FD095	1						MF	-		
NK 7	50	10	FD341	1						FD252			
SPEEDDAKE	50	95	FD153	1	DF649	W				MF002	-		
SPEEDFIGHT	50	96	FD094	1	DF863	W	RW			MF002	-		
SPEEDFIGHT 2	50	00	FD094	1	DF863	W	RW			MF002	-		
SPEEDFIGHT 3	50	09	FD073	1						MF002	-		
SPEEDFIGHT 3 LC	50	09	FD073	1						FD220			
SPEEDFIGHT LC	50	97	FD065	1	DF863	W	RW			FD065	DF863	W	RW
SQUAB	50	95	FD065	1	DF629	W	RW	FLS		MF002	-		
SV GEO	50	91	MF002		-					MF002	-		
SV 50 APS, GEO	50	91	MF002		-					MF002	-		
SV 50 D, SPORT, T	50	94	FD147	1	DF649	W				MF002	-		
SV 50 GEO	50	92	FD147	1	DF649	W				MF002	-		
SV 50 GEO	50	93	FD144	1	DF649	W				MF002	-		
SV EXECUTIVE	50	95	FD065	1						MF002	-		
TREKKER OFF ROAD	50	97	FD094	1	DF649	W				MF002	-		
TREKKER ROAD	50	97	FD065	1	DF649	W				MF002	-		
TWEET 50	50	10	FD188	1						MF	-		
V-CLIC 50	50	08	FD136	1						MF002	-		
VIVACITY	50	99	FD065	1	DF649	W				MF002	-		
VIVACITY SIXTIES	50	10	FD175	1	DF649	W				MF002	-		
XP 6 ENDURO	50	05	FD065	1						FD065			
XP 6 SM	50	05	FD065	1						FD065			
XP 6 TOP ROAD	50	06	FD065	1						FD065			
XPS ENDURO	50	05	FD065	1						FD065			
XPS SM	50	05	FD162	1	DF892	W				FD065			
XPS STREET	50	05	FD162	1						FD065			
XR 6	50	05	FD133	1						FD065			
XR 7	50	08	FD341	1						FD065			
XR 7	50	10	FD341	1						FD252			
ZENITH	50	94	FD147	1	DF642	W				MF002	-		
ZENITH LM	50	95	FD065	1	DF642	W				MF002	-		
ZENITH 50	50	93	FD147	1	DF642	W				MF002	-		
METROPOLIS 80	80	91	MF002		-					MF	-		
SPEEDFIGHT 80	80	96	FD094	1	DF863	W	RW			MF002	-		
ELYSEO 100	100	98	FD065	1	DF864	W				MF002	-		
LOOXOR	100	01	FD065	1						FD065	DF649	W	
SPEEDFIGHT 100	100	97	FD065	1	DF863	W	RW			FD065	DF863	W	RW
SPEEDFIGHT 100	100	97	FD094	1	DF863	W	RW			FD065	DF863	W	RW
TREKKER ROAD	100	98	FD065	1	DF649	W				MF002	-		
VIVACITY	100	99	FD065	1	DF649	W				MF002	-		
CITY STAR 125	125	11	FD277	1						FD228			
CITY STAR 125 ACTIVE	125	13	FD277	1						FD228			
DJANGO ALLURE	125	14	FD086	1						FD220			
DJANGO SPORT	125	14	FD086	1						FD220			
ELYSEO 125	125	98	FD065	1	DF864	W				MF002	-		
ELYSEO 125	125	01	FD065	1	DF864	W				FD065	DF864	W	
ELISTAR EFI	125	02	FD162	1						FD270			
GEO SV	125	92	FD147	1	DF649	W				MF002	-		
GEO 125 RS	125	10	FD162	1						FD270			
GEOPOLIS 125 (AJP)	125	06	FD162	1						FD270			
GEOPOLIS 125 (NISSIN)	125	06	FD187	1						FD187			



BRAND & MODEL · MARCA Y MODELO MARCA E MODELLO · MARQUE ET MODÈLE	C.C.	YEAR	FRONT					REAR				KITS KG		
			FD _{MF}	N°	DF	OE	UPGRADE 1	UPGRADE 2	FD _{MF}	DF	OE		UPGRADE	
continue PEUGEOT														
JET FORCE	125	03		FD162	1						FD270			
LOOXOR	125	01	04	FD065	1						FD065	DF649	W	
LOOXOR	125	05		FD245	1						FD270			
LUDIX 125	125	04		FD065	1						MF002	-		
LXR 125	125	10		FD162	1						FD399			
NEW VIVACITY 125	125	10		FD187	1						MF	-		
NEW VIVACITY 125 SIXTIES	125	10		FD095	1						MF	-		
SATELIS 125 K15 (AJP)	125	06		FD162	1						FD270			
SATELIS 125 K15 (NISSIN)	125	07		FD086	1						FD270			
SATELIS 125 K15 COMPRESOR (AJP)	125	06		FD162	1						FD270			
SATELIS 125 K15 COMPRESOR (NISSIN)	125	07		FD086	1						FD270			
SATELIS 125	125	10		FD162	1						FD270			
SATELIS 125 RS	125	13		FD086	1						FD200			
SUM-UP	125	08		FD095	1						MF451	-		
SV EXECUTIVE/GEO	125	91	94	FD147	1	DF649	W				MF002	-		
SV EXECUTIVE/GEO	125	95		FD144	1	DF649	W				MF002	-		
TWEET 125	125	10		FD188	1						FD200			
VOX CITY	125	10		FD073	1						MF	-		
XPS CT 125	125	06		FD065	1						FD065			
DJANGO EVASION	150	14		FD086	1						FD220			
DJANGO HERITAGE	150	14		FD086	1						FD220			
ELYSEO 150	150	01		FD162	1	DF864	W				FD270	DF864	W	
LOOXOR	150	02		FD065	1						FD065	DF649	W	
TWEET 150	150	10		FD188	1						FD200			
LXR 200	200	10		FD188	1						FD399			
GEO 250 RS	250	10		FD187	1						FD270			
GEOPOLIS 250 PREMIUM	250	06		FD277	1						FD277			
SATELIS 250 CITY	250	06		FD220	1						FD200			
SATELIS 250 RS	250	10		FD086	1						FD086			
SV 250	250	01	02	FD207	1	DF007	W				MF044	-		
SV 250	250	03		FD207	1	DF007	W				FD134	DF013	W	
GEO STYLE 300	300	10		FD187	1						FD187			
GEOPOLIS 300	300	11		FD187	1						FD187			
SATELIS 300i	300	13		FD086	1						FD086			
GEO 400 RS	400	10		FD140	1						FD187			
GEOPOLIS 400	400	07		FD187	1						FD187			
METROPOLIS 400i	400	12		FD138	2						FD086			
SATELIS 400	400	07		FD140	2						FD220			
SATELIS 400 ABS PBS	400	07		FD140	1						FD220			
SATELIS 500	500	06		FD220	2	DF667	W				FD220	DF666	W	
SATELIS 500 ABS PBS	500	07		FD140	2						FD220			
SATELIS 500	500	07	09	FD140	1						FD220			
SATELIS 500	500	10		FD140	1						FD187			
PIAGGIO														
VESPA ELETTRICA	EL	19		FD200	1						MF	-		
50 VESPINO F9 FAST RIDER	50	93		FD152	1						MF	-		
DIESIS	50	03		FD065	1						MF301	-		
FLY 50 2T	50	05		FD277	1	DF650	W	RW			MF	-		
FLY 50 4T	50	05		FD277	1	DF650	W	RW			MF	-		
FREE	50	94	95	MF618		-					MF631	-		
FREE 50	50	96		FD152	1						MF631	-		
LIBERTY 50	50	97	99	FD200	1	DF704	W	FLW			MF	-		
LIBERTY 50 4T	50	00	08	FD200	1	DF704	W	FLW			MF	-		
LIBERTY 50 4T	50	09		FD277	1						MF	-		
NRG	50	94	98	FD153	1	DF629	W	RW	FLS		MF621	-		
NRG EXTREME AIRE	50	99		FD153	1	DF737	W				MF621	-		
NRG EXTREME AGUA	50	99		FD153	1	DF737	W				FD200	DF705	W	
NRG POWER DD	50	05		FD094	1	DF704	W	FLW			FD200	DF705	W	
NRG POWER PURE JET	50	05		FD094	1	DF704	W	FLW			FD200	DF705	W	
NRG=MC2	50	98	03	FD153	1	DF629	W	RW	FLS		FD200	DF705	W	
NRG=MC3 PURE JET	50	04		FD094	1	DF704	W	FLW			FD200	DF705	W	
NTT	50	95		FD153	1	DF629	W	RW	FLS		MF621	-		
QUARTZ	50	92		FD152	1	DF650	W	RW			MF621	-		
S 50 4T	50	09		FD200	1						MF	-		
SCATTO	50	90		MF637		-					MF637	-		
SFERA	50	90	95	MF620		-					MF621	-		
SFERA	50	96		FD197	1	DF362	W				MF621	-		
STORM	50	94		FD153	1	DF629	W	RW	FLS		MF621	-		
TYPHOON	50	94	95	FD153	1	DF629	W	RW	FLS		MF621	-		
TYPHOON	50	96	98	FD153	1	DF629	W	RW	FLS		MF717	-		
TYPHOON-X	50	99	10	FD153	1	DF629	W	RW	FLS		MF717	-		
TYPHOON	50	11		FD277	1	DF737	W				MF	-		



APPLICATIONS
 PADS FD
 DISCS DF
 SHOES MF
 LINES FK
 BRACKETS SP
 KITS KG
 CROSS REFERENCE



APPLICATIONS

PADS **FD**

DISCS **DF**

SHOES **MF**

LINES **FK**

BRACKETS **SP**

KITS **KG**

CROSS REFERENCE

BRAND & MODEL * MARCA Y MODELO MARCA E MODELLO * MARQUE ET MODÈLE	C.C.	YEAR	FRONT					REAR					KITS KG
			FD	N°	DF	OE	UPGRADE 1	UPGRADE 2	FD	DF	OE	UPGRADE	
continue PIAGGIO													
VESPA 50 ET2	50	00	FD200	1	DF362	W			MF636	-			
VESPA 50 ET4	50	01	FD200	1	DF362	W			MF636	-			
VESPA 50 S 4V	50	09	FD200	1	DF362	W			MF636	-			
ZIP	50	92	MF617		-				MF636	-			
ZIP FAST-RIDER	50	93	FD153	1	DF466	W			MF636	-			
ZIP SP LC	50	96	FD200	1	DF362	W			MF636	-			
ZIP CATALIZADA	50	00	FD200	1	DF704	W	FLW		MF636	-			
ZIP 4T	50	00	FD200	1	DF705	W			MF636	-			
SFERA 75	75	90	MF620		-				MF621	-			
TYPHOON	80	95	FD153	1	DF629	W	RW	FLS	MF621	-			
TYPHOON	80	96	FD153	1	DF629	W	RW	FLS	MF717	-			
FLY 100	100	07	FD277	1	DF650	W	RW		MF717	-			
FREE 100	100	02	FD153	1	DF704	W	FLW		MF717	-			
ZIP 100	100	07	FD200	1	DF704	W	FLW		MF636	-			
BEVERLY 125 4T (G)	125	02	FD162	1	DF667	W			FD162	DF667	W		
BEVERLY 125 4T (H)	125	02	FD277	1	DF667	W			FD334	DF667	W		
BEVERLY 125	125	10	FD277	1	DF666	W			FD277	DF666	W		
CARNABY 125	125	07	FD277	1	DF667	W			FD277	DF667	W		
FLY 125 4T	125	05	FD277	1	DF362	W			MF717	-			
HEXAGON	125	94	FD153	1					MF636	-			
HEXAGON LX 125 (G)	125	98	FD162	1	DF362	W			MF	-			
HEXAGON LX 125 (H)	125	98	FD277	1	DF362	W			MF	-			
HEXAGON GTX 125 (G)	125	00	FD162	1	DF650	W	RW		FD263	DF650	W	RW	
HEXAGON GTX 125 (H)	125	00	FD277	1	DF650	W	RW		FD263	DF650	W	RW	
LIBERTY 4-T	125	98	FD200	1	DF704	W	FLW		MF	-			
LIBERTY 4-T	125	09	FD277	1					MF	-			
LIBERTY 4-T ie	125	15	FD409	1					MF	-			
MEDLEY 125	125	20	FD409	1					FD334				
MP 3 125	125	06	FD200	2	DF714	W			FD536	DF666	W		
MP 3 HYBRID	125	09	FD200	2	DF714	W			FD334	DF666	W		
MP 3 125 LT	125	09	FD200	2	DF714	W			FD334	DF666	W		
MP 3 125 YOURBAN	125	11	FD200	2	DF714	W			FD334	DF666	W		
SFERA 4T	125	96	FD200	1	DF650	W	RW		MF636	-			
SKIPPER	125	93	FD152	1	DF650	W	RW		MF636	-			
SKIPPER LX (G)	125	98	FD162	1	DF737	W			MF	-			
SKIPPER LX (H)	125	98	FD277	1	DF737	W			MF	-			
SKR 125 ST 4T (G)	125	00	FD162	1	DF737	W			MF	-			
SKR 125 ST 4T (H)	125	00	FD277	1	DF737	W			MF	-			
SUPER HEXAGON GTX 125 (G)	125	01	FD162	1					FD263	DF704	W	FLW	
SUPER HEXAGON GTX 125 (H)	125	01	FD277	1					FD263	DF704	W	FLW	
TYPHOON	125	95	FD153	1	DF629	W	RW	FLS	MF621	-			
TYPHOON	125	96	FD153	1	DF629	W	RW	FLS	MF717	-			
TYPHOON 4T	125		FD277	1	DF737	W			MF	-			
VESPA 946	125	13	FD277	1					FD263				
VESPA RED 946	125	17	FD277	1					FD263				
VESPA ET4	125	96	FD200	1	DF362	W			MF636	-			
VESPA GRAN TURISMO (G)	125	03	FD162	1	DF704	W	FLW		FD263	DF704	W	FLW	
VESPA GRAN TURISMO (H)	125	03	FD277	1	DF704	W	FLW		FD263	DF704	W	FLW	
VESPA GTS 125 ABS-ASR	125	17	FD277	1	DF704	W	FLW		FD200				
VESPA GTS 125 SUPER	125	09	FD277	1	DF704	W	FLW		FD200				
VESPA GTV 125	125	06	FD277	1	DF704	W	FLW		FD263	DF704	W	FLW	
VESPA LX 125 4T 3V	125	05	FD200	1	DF362	W			MF636				
VESPA PRIMAVERA	125	15	FD277	1	DF362	W			MF636				
VESPA PRIMAVERA ABS	125	17	FD277	1	DF362	W			MF636				
VESPA SPRINT	125	15	FD277	1	DF362	W			MF636				
VESPA SPRINT SPORT ABS	125	17	FD277	1	DF362	W			MF636				
X 7	125	08	FD277	1					FD334				
X 8	125	04	FD277	1	DF667	W			FD220	DF666	W		
X 8	125	06	FD277	1	DF667	W			FD536	DF666	W		
X 9	125	01	FD220	2	DF666	W			FD220	DF666	W		
X 9 EVOLUTION LEFT/IZQ.	125	04	FD277	2	DF667	W							
X 9 EVOLUTION RIGHT/DER.	125	04	FD334	2	DF667	W			FD220	DF666	W		
X 9 EVOLUTION LEFT/IZQ.	125	06	FD277	2	DF667	W							
X 9 EVOLUTION RIGHT/DER.	125	06	FD334	2	DF667	W			FD343	DF666	W		
X 10 LEFT/IZQ	125	12	FD277	2									
X 10 RIGHT/DER	125	12	FD334	2					FD343				
X EVO 125	125	08	FD277	1	DF667	W			FD334	DF666	W		
ZIP 125	125	00	FD200	1					MF	-			
HEXAGON	150	94	FD153	1					MF636	-			
HEXAGON GTX 150 (G)	150	00	FD162	1	DF650	W	RW		FD263	DF650	W	RW	
HEXAGON GTX 150 (H)	150	00	FD277	1	DF650	W	RW		FD263	DF650	W	RW	
LIBERTY 4-T	150	00	FD200	1	DF704	W	FLW		MF	-			



BRAND & MODEL · MARCA Y MODELO MARCA E MODELLO · MARQUE ET MODÈLE	C.C.	YEAR	FRONT					REAR				KITS	
			FD _{MF}	N°	DF	OE	UPGRADE 1	UPGRADE 2	FD _{MF}	DF	OE	UPGRADE	KG
continue PIAGGIO													
MEDLEY 150	150	19	FD409	1						FD334			
SKIPPER	150	93 97	FD152	1	DF650	W	RW			MF636			
SKIPPER LX (G)	150	98 99	FD162	1	DF737	W				MF	-		
SKIPPER LX (H)	150	98 99	FD277	1	DF737	W				MF	-		
SKR 150 ST 4T (G)	150	00	FD162	1	DF737	W				MF	-		
SKR 150 ST 4T (H)	150	00	FD277	1	DF737	W				MF	-		
VESPA ET4	150	01	FD200	1	DF362	W				MF636			
VESPA S 150	150	09	FD200	1	DF362	W				MF636			
VESPA LX 150 4T 3V	150	08	FD200	1	DF362	W				MF636			
VESPA SUPER SPORT ABS	150	15	FD277	1	DF704	W	FLW			FD200			
HEXAGON GTX 180 (G)	180	00 00	FD162	1	DF650	W	RW			FD263	DF650	W	RW
HEXAGON GTX 180 (H)	180	00 00	FD277	1	DF650	W	RW			FD263	DF650	W	RW
HEXAGON LXT 180 (G)	180	98 99	FD162	1	DF362	W				MF	-		
HEXAGON LXT 180 (H)	180	98 99	FD277	1	DF362	W				MF	-		
SUPER HEXAGON GTX 180 (G)	180	01	FD162	1						FD263	DF704	W	FLW
SUPER HEXAGON GTX 180 (H)	180	01	FD277	1						FD263	DF704	W	FLW
X 9 AMALFI	180	01	FD220	2	DF666	W				FD220	DF666	W	
BEVERLY 200 4T (G)	200	02	FD162	1	DF667	W				FD162	DF667	W	
BEVERLY 200 4T (H)	200	02	FD277	1	DF667	W				FD277	DF667	W	
CARNABY 200	200	07	FD277	2	DF667	W				FD277	DF667	W	
LIBERTY	200	04	FD200	1						MF	-		
VESPA GRAN TURISMO (G)	200	03	FD162	1	DF704	W	FLW			FD263	DF704	W	FLW
VESPA GRAN TURISMO (H)	200	03	FD277	1	DF704	W	FLW			FD263	DF704	W	FLW
X 8	200	04	FD277	1	DF667	W				FD536	DF666	W	
X 9	200	01 02	FD220	2	DF666	W				FD220	DF666	W	
X 9 EVOLUTION IZQ.	200	03	FD277	2	DF667	W							
X 9 EVOLUTION DER.	200	03	FD334	2	DF667	W				FD220	DF666	W	
BEVERLY 250 4T (H)	250	04	FD277	1	DF667	W				FD277	DF667	W	
CARNABY 250	250	09	FD277	2	DF666	W				FD277	DF666	W	
HEXAGON GT 250 4-T (G)	250	98 99	FD162	1	DF650	W	RW			MF451	-		
HEXAGON GT 250 4-T (H)	250	98 99	FD277	1	DF650	W	RW			MF451	-		
HEXAGON GTX 250 (G)	250	00	FD162	1	DF650	W	RW			FD263	DF650	W	RW
HEXAGON GTX 250 (H)	250	00	FD277	1	DF650	W	RW			FD263	DF650	W	RW
MP 3 250	250	06 08	FD200	2	DF714	W				FD536	DF666	W	
MP 3 250 LT	250	09	FD200	2	DF714	W				FD334	DF666	W	
VESPA GTE 250 I	250	05	FD277	1	DF704	W	FLW			FD343	DF704	W	FLW
X 7	250	08	FD277	1						FD334			
X 8	250	06	FD277	1	DF667	W				FD536	DF666	W	
X 9	250	00	FD220	2	DF666	W				FD220	DF666	W	
X 9 EVOLUTION LEFT/IZQ.	250	04	FD277	2	DF666	W							
X 9 EVOLUTION RIGHT/DER.	250	04	FD334	2	DF666	W				FD536	DF666	W	
X EVO 250	250	08	FD277	1	DF667	W				FD277	DF666	W	
BEVERLY 300	300	10	FD277	1	DF666	W				FD334	DF666	W	
BEVERLY TOURER 300	300	09	FD277	1	DF667	W				FD334	DF667	W	
CARNABY CRUISER 300 i.e.	300	09	FD277	1	DF667	W				FD277	DF667	W	
MP 3 300 LT SPORT	300	11	FD200	2	DF714	W				FD334	DF666	W	
MP 3 300 YOURBAN	300	11	FD200	2	DF714	W				FD334	DF666	W	
MP 3 300 ie YOURBAN	300	13	FD200	2	DF714	W				FD334	DF666	W	
MP 3 NEW 300 BUSINESS	300	15	FD263	2		W				FD	DF714	W	
MP 3 NEW 300 SPORT	300	15	FD263	2		W				FD	DF714	W	
VESPA GTS 300 ABS-ASR	300	17	FD277	1	DF704	W	FLW			FD200			
VESPA GTS 300 i.e. SUPER	300	09	FD277	1	DF704	W	FLW			FD343	DF704	W	FLW
X 7	300	10	FD277	1	DF667	W				FD334	DF666	W	
BEVERLY SPORT TOURER	350	12	FD245	1	DF666	W				FD334	DF666	W	
X 10 LEFT/IZQ	350	12	FD277	2									
X 10 RIGHT/DER	350	12	FD334	2						FD343			
BEVERLY 400 i.e.	400	06	FD138	1	DF667	W				FD220	DF666	W	
BEVERLY 400 i.e. TOURER	400	06	FD220	2						FD220	DF666	W	
MP 3 400 i.e.	400	07	FD200	2	DF714	W				FD277	DF666	W	
MP 3 400 LT	400	09	FD200	2	DF714	W				FD277	DF666	W	
X 8 i.e.w. LEFT/IZQ.	400	06	FD277	2	DF666	W							
X 8 i.e.w. RIGHT/DER.	400	06	FD334	2	DF666	W				FD220	DF666	W	
X EVO 400 LEFT/IZQ.	400	08	FD277	2	DF666	W							
X EVO 400 RIGHT/DER.	400	08	FD334	2	DF666	W				FD277	DF666	W	
BEVERLY 500	500	03	FD220	2	DF667	W				FD220	DF666	W	
MP 3 500 SPORT	500	10 14	FD200	2	DF714	W				FD277	DF666	W	
MP 3 NEW 500 BUSINESS	500	15	FD263	2	DF721	W				FD277	DF714	W	
MP 3 NEW 500 SPORT	500	15	FD263	2	DF721	W				FD277	DF714	W	
MP 3 NEW 500 BUSINESS ABS/ASR	500	15	FD263	2	DF721	W				FD277	DF714	W	
MP 3 NEW 500 SPORT ABS/ASR	500	15	FD263	2	DF721	W				FD277	DF714	W	
X 9	500	01 02	FD220	2	DF667	W				FD220	DF666	W	
X 9 EVOLUTION	500	03	FD138	2	DF667	W				FD220	DF666	W	



APPLICATIONS
 PADS FD
 DISCS DF
 SHOES MF
 LINES FK
 BRACKETS SP
 KITS KG
 CROSS REFERENCE



APPLICATIONS

PADS FD

DISCS DF

SHOES MF

LINES FK

BRACKETS SP

KITS KG

CROSS REFERENCE

BRAND & MODEL · MARCA Y MODELO MARCA E MODELLO · MARQUE ET MODÈLE	C.C.	YEAR	FRONT				REAR				KITS KG	
			FD _{MF}	N°	DF	OE	UPGRADE 1	UPGRADE 2	FD _{MF}	DF		OE
continue PIAGGIO												
X 9 i.e.	500	07	FD138	2	DF667	W			FD220	DF666	W	
X 10 LEFT/IZQ	500	12	FD277	2								
X 10 RIGHT/DER	500	12	FD334	2					FD343			
POCKETBIKE												
CALIPER POLINI			FD158	1								
POLARIS												
V 92 C	1500	00	FD176	2					FD172			
V 92 SC	1500	00	FD176	2					FD172			
POLARIS 4 Wheels												
HAWKEYE 300 2X4/4X4	300	06 06	FD353	2					FD353			
HAWKEYE 300 2X4/4X4	300	07	FD303	2					FD303			
XPRESS 300	300	96 00	FD303	2					FD300			
XPEDITION 325	325	00	FD303	2	DF722	W			FD301	DF725	W	
MAGNUM 325 All Models	325	00 01	FD303	2	DF722	W			FD301	DF735		
MAGNUM 325 All Models	325	02	FD303	2	DF722	W			FD317			
MAGNUM 330 All Models	330	03	FD303	2					FD317			
SPORTSMAN 335	335	99 00	FD303	2					FD301			
SPORTSMAN 350	350	93	FD303	2					FD300			
RANGER 400	400	10	FD	2					FD			
SPORT 400	400	94 98	FD303	2					FD300			
SPORT 400	400	99	FD303	2					FD301	DF725	W	
SPORTSMAN 400	400	00 02	FD303	2					FD301			
SPORTSMAN 400	400	03	FD303	2					FD317			
SPORTSMAN 400	400	94 97	FD303	2					FD300			
SPORTSMAN 400 HO 4X4	400	08 10	FD303	2					FD303			
SPORTSMAN 400 HO 4X4	400	11	FD303	2					FD			
MAGNUM 425 All Models 2X4	425	95 97	FD303	2					FD300			
MAGNUM 425 All Models 4X4	425	95 97	FD303	2					FD300			
XPEDITION 425	425	00	FD303	2					FD301	DF725	W	
OUTLAW 450 S	450	08	FD404	2					FD303			
SPORTSMAN 450	450	06 06	FD303	2	DF722	W			FD317			
SPORTSMAN 450	450	07	FD303	2	DF722	W			FD317			
MAGNUM 500 All Models	500	99 01	FD303	2					FD301	DF725	W	
MAGNUM 500 All Models	500	02	FD303	2					FD317			
PREDATOR 500	500	03	FD303	2	DF898	W			FD303	DF899	W	
RANGER 500 2X4/4X4	500	02 07	FD	2					FD			
RANGER 500 2X4/4X4 efi	500	08	FD491	2	DF722	W			FD			
SCRAMBLER 500 2X4	500	07	FD303	2	DF722	W			FD317	DF725	W	
SCRAMBLER 500 4X4	500	07	FD303	2					FD317	DF725	W	
SPORTSMAN 500	500	96 97	FD303	2					FD300			
SPORTSMAN 500	500	98 02	FD303	2					FD301			
SPORTSMAN 500	500	03	FD303	2					FD317			
SPORTSMAN 500 FOREST	500	12	FD303	2					FD317			
SPORTSMAN 500 TOUNING HO	500	08 10	FD303	2					FD303			
SPORTSMAN 500 TOUNING HO	500	11	FD303	2					FD			
OUTLAW 525 S	525	08	FD404	2					FD303			
OUTLAW 525 IRS	525	08	FD404	2					FD303			
RANGER 700 6X4 efi	700	08	FD491	2	DF722	W			FD			
RANGER 700 XP 4X4 efi	700	08	FD491	2	DF722	W			FD			
SPORTSMAN 700	700	02	FD303	2					FD317			
RANGER 800 6X6	800	10	FD	2					FD			
RANGER 800 CREW	800	10	FD	2					FD			
RANGER 800 HD	800	10	FD	2					FD			
RANGER 800 RZR	800	08	FD404	2					FD303			
RANGER 800 RZR-4 EPS	800	12	FD	2					FD			
RANGER 800 XP	800	10	FD	2					FD			
SPORTSMAN 800 efi	800	07	FD303	2	DF722	W			FD317			
SPORTSMAN 800 X2 efi	800	07	FD303	2	DF722	W			FD303			
RANGER 900 RZR XP	900	12	FD	2					FD			
SCRAMBLER All Models		95 97	FD303	2					FD300			
SCRAMBLER All Models		98 06	FD303	2	DF722	W			FD301	DF725	W	
TRAIL BLAZER All Models		90 98	FD303	2					FD300			
TRAIL BLAZER All Models		99	FD303	2	DF722	W			FD301	DF725	W	
TRAIL BOSS All Models		00	FD303	2					FD301			
XPLOER All Models		95 99	FD303	2					FD300			
XPLOER All Models		00	FD303	2					FD301			
POLARIS RZR												
RZR 750	750	12	FD404	2					FD			
RZR 800 RANGER	800	08 14	FD404	2					FD			
RZR-4 800 EFI	800	10 14	FD491	2					FD			
RZR EPS 800 RANGER	800	12	FD491	2					FD			
RZR-4 XP 900	900	12 14	FD491	2					FD491			



BRAND & MODEL · MARCA Y MODELO MARCA E MODELLO · MARQUE ET MODÈLE	C.C.	YEAR	FRONT					REAR				KITS KG
			FD	N°	DF	OE	UPGRADE 1	UPGRADE 2	FD	DF	OE	
continue POLARIS RZR												
RZR XP TURBO	925	16	FD506	2	DF982	W		FD491	DF982	W		
RZR XP4 TURBO	925	16	FD506	2	DF982	W		FD491	DF982	W		
RZR 1000	1000	16	18	FD404	2			FD404				
RZR XP 1000	1000	14		FD491	2	DF972	W	V	FD491	DF972	W	V
POLARIS SNOW												
WILDWOOD BRAKES TODOS		01						FD182				
POLINI												
XP 4 STREET 50	50	08		FD224	1			FD224				
XP 65 R MINICROSS	65	08		FD224	1			FD224				
XP 4T CROSS	100	08		FD224	1			FD224				
XP 4T MINIMOTARD	100	08		FD224	1			FD224				
XP 4T RACING CROSS	100	08		FD224	1			FD224				
XP 4 STREET 125	125	08		FD224	1			FD224				
XP 4 OFF ROAD	125	08		FD224	1			FD224				
PVM												
RACING CALIPER		90		FD139	1							
QINGQI COLOMBIA												
MOPED 110	110			FD117	1			MF	-			
421 R SCOOTER	125			FD095	1			MF	-			
SUPRA 125 T10-E	125			FD136	1			MF	-			
REMMIX SCOOTER 125	125			FD086	1			MF	-			
QMR 200 ENDURO	200			FD086	1			MF	-			
QMT 200 SUPERMOTARD	200			FD086	1			MF	-			
QMR 200 SP	200			FD086	1			FD095				
RENAULT												
CAMPUS	50	02		FD153	1	DF649	W		MF	-		
SPC 50	50	02		FD153	1			MF	-			
FULLTIME	125	02		FD153	1			FD200				
KOURANOS	125	02		FD153	1			FD200				
FULLTIME	150	02		FD153	1			FD200				
KOURANOS	250	02		FD153	1			FD200				
RIEJU												
NUUK CARGO	EL	18		FD450	1			FD075				
NUUK TRACKER	EL	18		FD450	1			FD075				
NUUK URBAN	EL	18		FD450	1			FD075				
CROSSER CR1	50	96		FD071	1	DF649	W	MF002	-			
DRAC AIR, DL	50	94		FD065	1			MF	-			
EVASION	50	09		FD085	1			MF	-			
F 10 JET LINE	50	95		FD153	1	DF649	W	MF002	-			
FIRST	50	95		FD071	1	DF649	W	MF002	-			
MRT 50	50	09		FD252	1			FD252				
MRT PRO 50	50	09		FD220	1	DF759	W	FD252	DF758	W		
MRT SM 50	50	09		FD252	1			FD252				
MRT SM PRO 50	50	09		FD220	1	DF759	W	FD252	DF758	W		
MRT SM 50 TROPHY	50	16		FD162	1	DF759	W	FD286	DF758	W		
MRX 50	50	03	07	FD162	1	DF674	W	FLW	FD065	DF675	W	
MRX 50 PRO	50	08		FD220	1	DF759	W		FD065	DF758	W	
PACIFIC	50	07		FD095	1			MF	-			
RR 50 GV	50	96	98	FD065	1			FD065				
RR 50 CASTROL	50	99		FD133	1	DF674	W	FLW	FD065	DF675	W	
RR DL	50	94	95	FD065	1			MF	-			
RR SPIKE	50	99		FD065	1			FD065				
RS-1 AGUA	50	94	95	FD065	1			MF	-			
RS-1 EVOLUTION	50	98	02	FD065	1			FD065				
RS-2 MATRIX	50	03	05	FD297	1	DF683	W	FD270	DF684	W		
RS-2 NKD	50	04	05	FD297	1	DF683	W	FD270	DF684	W		
RS-2	50	06		FD298	1	DF738	W	FD094				
RS-2 NKD	50	06		FD297	1	DF738	W	FD270				
RS-3	50	11		FD073	1			FD094				
SMX	50	02		FD065	1	DF674	W	FLW	FD065	DF675	W	
SPIKE X 50	50	06		FD065	1			FD065				
TANGO 50	50	07	08	FD220	1	DF674	W	FLW	FD065	DF675	W	
TANGO 50	50	09		FD252	1	DF674	W	FLW	FD065	DF675	W	
TANGO 50 (SEGÚN MODELO)	50	09		FD409	1	DF674	W	FLW	FD065	DF675	W	
TANGOO 50	50	08		FD220	1	DF674	W	FLW	FD065	DF675	W	
TOREO	50	08		FD095	1			MF	-			
WINDY	50	94		FD065	1			MF630	-			
RST 80	80	90		FD071	1			FD065				
CENTURY 125	125	18		FD341	1			FD075				
CITY LINE 125 i.e.	125	14		FD162	1			FD220				
CITY LINE 125 i.e. ABS	125	16		FD162	1			FD220				
MARATHON PRO 125	125	09		FD220	1			FD252				



APPLICATIONS
 PADS FD
 DISCS DF
 SHOES MF
 LINES FK
 BRACKETS SP
 KITS KG
 CROSS REFERENCE



APPLICATIONS

PADS **FD**

DISCS **DF**

SHOES **MF**

LINES **FK**

BRACKETS **SP**

KITS **KG**

CROSS REFERENCE

BRAND & MODEL * MARCA Y MODELO MARCA E MODELLO * MARQUE ET MODÈLE	C.C.	YEAR	FRONT					REAR				KITS KG	
			FD	N°	DF	OE	UPGRADE 1	UPGRADE 2	FD	DF	OE		UPGRADE
continue RIEJU													
MARATHON PRO 125 COMPETICION	125	11	FD409	1						FD456			
MARATHON PRO 125 SM	125	09	FD220	1						FD252			
MXR 125 4T	125	03	FD133	1	DF674	W	FLW			FD065	DF675	W	
NKD 125	125	06	FD297	1						FD270			
PACIFIC	125	07	FD095	1						MF	-		
RS-2	125	06	FD298	1						FD094			
RS-2 NKD	125	06	FD298	1						FD094			
RS-3	125	10	FD341	1						FD252			
RS-3	125	13	FD341	1						FD075			
RS-3 NKD	125	13	FD341	1						FD075			
SMX 125 4T	125	03	FD133	1	DF674	W	FLW			FD065	DF675	W	
SMX 125	125	08	FD220	1						FD065			
TANGO 125	125	06	FD220	1	DF674	W	FLW			FD065	DF675	W	
TANGO 125 PRO	125	07	FD220	1	DF677	W	FLW	FLS		FD065	DF675	W	
TANGO 125	125	11	FD409	1						FD065			
MARATHON 250	250	09	FD138	1	DF301	FLW	FLS	FRS		FD291	DF479	W	
MRX 250	250	06	FD164	1	DF301	FLW	FLS	FRS		FD093	DF479	W	
TANGO OFF ROAD 250	250	09	FD220	1	DF677	W	FLW	FLS		FD065	DF675	W	
TANGO ROAD 250	250	09	FD220	1	DF677	W	FLW	FLS		FD065	DF675	W	
TANGO TRAIL 250	250	09	FD220	1	DF677	W	FLW	FLS		FD065	DF675	W	
TANGO 250	250	11	FD409	1						FD065			
CITY LINE 300 i.e.	300	14	FD162	1						FD220			
CITY LINE 300 i.e. ABS	300	16	FD162	1						FD220			
MR 300 PRO	300	20	FD164	1	DF677	FLW				FD286	DF678	W	
MR 300 RACING	300	20	FD164	1	DF677	FLW				FD286	DF678	W	
MR 300 RANGER	300	20	FD164	1	DF677	FLW				FD286	DF678	W	
MARATHON 450	450	09	FD138	1	DF301	FLW	FLS	FRS		FD291	DF479	W	
MRX 450	450	05	FD164	1	DF301	FLW	FLS	FRS		FD093	DF479	W	
ROYAL ENFIELD													
BULLET CLASIC (TODAS)	500	09	FD187	1						MF	-		
BULLET TRIALS WORK	500	20	FD138	1						FD165	DF551	W	
CLASSIC 500	500	20	FD138	1						FD165	DF551	W	
CLUBMAN	500	09	FD187	1						MF	-		
EFI	500	09	FD187	1						MF	-		
EFI DE LUXE	500	09	FD187	1						MF	-		
HIMALAYA	500	20	FD138	1	DF552	W				FD165	DF551	W	
KIT ES	500	09	FD187	1						MF	-		
SCRAMBLER 500	500	20	FD138	1						FD165	DF551	W	
TRAIL	500	09	FD187	1						MF	-		
THUNDERBIRD X	500	20	FD138	1						FD165	DF551	W	
CONTINENTAL GT 535	535	14	FD172	1						FD165			
CONTINENTAL GT 650	650	18	FD172	1	DF550	FLW				FD165	DF551	W	
INTERCEPTOR INT 650	650	18	FD172	1	DF550	FLW				FD165	DF551	W	
ROXON													
DUEL SM	50	06	FD065	1						FD065			
DUEL TT	50	06	FD065	1						FD065			
ROXON 4 Wheels													
RX 150	150	04	MF		-					FD094			
SPORT SPIRIT 150	150	04	MF		-					FD094			
SACHS													
BEE 50	50	08	FD079	1						MF	-		
MAD ASS 50	50	05	FD133	1						FD			
SPEEDFORCE 50	50	08	FD175	1						MF	-		
SPEEDJET 50	50	08	FD175	1						MF	-		
SX-1 50	50	08	FD175	1						MF	-		
49 ER 12ª	50	08	FD175	1						MF	-		
BEE 125	125	08	FD079	1						MF	-		
MAD ASS 125	125	05	FD133	1						FD095			
X ROAD 125	125	04	FD068	1						FD135			
TITAN 650	650	03	FD068	1						FD012			
b-805	800	03	FD068	1						FD012			
ROADSTER s-805	800	03	FD068	1						FD012			
SACHS 4 Wheels													
4 ROCK 250	250	04	MF		-					FD187			
SANYANG													
DUKE 125	125	94	FD188	1						MF	-		
SCARABEO													
50 2T	50	14	FD135	1	DF612	W				MF630	-		
50 4T	50	14	FD135	1	DF612	W				MF630	-		
100 4T	100	14	FD135	1	DF612	W				MF630	-		
125 ie	125	15	FD245	1	DF671	W	FLW			FD228	DF612	W	
SCOMADI													



BRAND & MODEL · MARCA Y MODELO MARCA E MODELLO · MARQUE ET MODÈLE	C.C.	YEAR	FRONT					REAR				KITS KG	
			FD _{MF}	N°	DF	OE	UPGRADE 1	UPGRADE 2	FD _{MF}	DF	OE		UPGRADE
continue SCOMADI													
LEGGERA TL 50	50	15	FD188	1						MF	-		
LEGGERA TL 125	125	15	FD188	1						MF	-		
LEGGERA TL 125 CHROME	125	15	FD188	1						MF	-		
SCORPA													
SY 125 F	125	05	FD223	1						FD224			
T-RIDE 125 F	125	10	FD409	1						FD270			
TWENTY 125	125	15	FD223	1	DF808	W				FD224	DF809	W	
TY S 125 F	125	05	FD065	1						FD224			
SY 500	163	08	FD223	1						FD224			
SY 175 F	175	05	FD223	1						FD224			
TY S 175 F	175	06	FD065	1						FD224			
2S5 WORKS	250	95	FD065	1						FD065			
ENDURO 2.5i	250	06	FD164	1						FD093			
SY 250	250	00	04	FD238	1					FD239			
SY 250	250	05	05	FD223	1					FD224			
SY 250 F	250	06	FD223	1						FD224			
SY 250 FR	250	10	FD223	1						FD224			
T-RIDE 250 F	250	08	FD409	1						FD410			
TWENTY 250	250	15	FD223	1	DF808	W				FD224	DF809	W	
EASY RACE 280	280	99	FD065	1						FD065			
TWENTY 300	300	15	FD223	1	DF808	W				FD224	DF809	W	
ENDURO 4.5i	450	06	FD164	1						FD093			
ENDURO 5.1i	510	06	FD164	1						FD093			
SCUTUM													
S 02 A.M.U.	EL	17	FD524	1						FD524			
S 02 DELIVERY	EL	17	FD524	1						FD524			
S 02 POLICIAL	EL	17	FD524	1						FD524			
SILENCE 02	EL	18	FD524	1						FD094			
SHERCO													
50 IPONE LIMITED	50	05	FD133	1						FD065			
0.8	80	03	12	FD223	1	DF808	W			FD224	DF809	W	
80 ST	80	15	FD223	1	DF808	W				FD224	DF809	W	
ST 8.0	80	13	14	FD446	1					FD224			
1.25	125	99	01	FD133	1					FD065			
1.25	125	02	05	FD223	1	DF808	W			FD224	DF809	W	
125 ST	125	15	FD223	1	DF808	W				FD224	DF809	W	
CITYCORP 125	125	03	FD133	1						FD065			
CITYCORP 125 SM	125	03	FD133	1						FD065			
SE 1.25 F	125	10	FD162	1						FD270			
SM 1.25 F	125	10	FD162	1						FD270			
ST 1.25	125	06	12	FD223	1	DF808	W			FD224	DF809	W	
ST 1.25	125	13	14	FD446	1	DF808	W			FD224	DF809	W	
2.0	200	99	05	FD065	1					FD065			
ST 2.0	200	06	FD223	1	DF808	W				FD224	DF809	W	
2.5	250	99	01	FD065	1					FD065			
2.5 02 Series	250	02	05	FD223	1	DF808	W			FD224	DF809	W	
2.5 if	250	09	FD138	1	DF772	FLW				FD093	DF670	W	PW
2.5 SEF-R ISDE	250	12	FD138	1	DF772	FLW				FD093	DF670	W	PW
250 SE FORK SACHS	250	14	FD138	1	DF772	FLW	FLS	FRS		FD291	DF921	W	PW
250 SE FORK WP	250	14	FD138	1	DF920	FLW	FLS	FRS		FD291	DF921	W	PW
250 SE-R FORK SACHS	250	14	FD138	1	DF772	FLW	FLS	FRS		FD291	DF921	W	PW
250 SE-R FORK WP	250	14	FD138	1	DF920	FLW	FLS	FRS		FD291	DF921	W	PW
250 SEF FORK SACHS	250	14	FD138	1	DF772	FLW	FLS	FRS		FD291	DF921	W	PW
250 SEF FORK WP	250	14	FD138	1	DF920	FLW	FLS	FRS		FD291	DF921	W	PW
250 SEF-R FORK SACHS	250	14	FD138	1	DF772	FLW	FLS	FRS		FD291	DF921	W	PW
250 SEF-R FORK WP	250	14	FD138	1	DF920	FLW	FLS	FRS		FD291	DF921	W	PW
250 ST	250	15	FD223	1	DF808	W				FD224	DF809	W	
SE 2.5i	250	12	13	FD138	1	DF772	FLW			FD291	DF670	W	PW
SE-R 2.5 ISDE	250	14	FD138	1	DF772	FLW	FLS	FRS		FD291	DF921	W	PW
ST 2.5	250	06	12	FD223	1	DF808	W			FD224	DF809	W	
ST 2.5	250	13	14	FD446	1	DF808	W			FD224	DF809	W	
SX 2.5 F	250	10	FD138	1	DF772	FLW				FD093	DF670	W	PW
2.9	290	99	00	FD065	1					FD065			
2.9	290	01	05	FD223	1	DF808	W			FD224	DF809	W	
290 ST	290	15	FD223	1	DF808	W				FD224	DF809	W	
ST 2.9	290	06	11	FD223	1	DF808	W			FD224	DF809	W	
ST 2.9	290	12	14	FD446	1	DF808	W			FD224	DF809	W	
X-RIDE	290	13	FD075	1	DF697					FD075	DF698	W	
3.0SEF-R ISDE	300	12	FD138	1	DF772	FLW				FD291	DF670	W	PW
300 SE FORK SACHS	300	14	FD138	1	DF772	FLW	FLS	FRS		FD291	DF921	W	PW
300 SE FORK WP	300	14	FD138	1	DF920	FLW	FLS	FRS		FD291	DF921	W	PW
300 SE-R FORK SACHS	300	14	FD138	1	DF772	FLW	FLS	FRS		FD291	DF921	W	PW

APPLICATIONS

PADS FD

DISCS DF

SHOES MF

LINES FK

BRACKETS SP

KITS KG

CROSS REFERENCE





APPLICATIONS

PADS

DISCS

SHOES

LINES

BRACKETS

KITS

CROSS REFERENCE

BRAND & MODEL * MARCA Y MODELO MARCA E MODELLO * MARQUE ET MODÉLE	C.C.	YEAR	FRONT						REAR				KITS
				N°		OE	UPGRADE 1	UPGRADE 2			OE	UPGRADE	
continue SHERCO													
300 SE-R FORK WP	300	14	FD138	1	DF920	FLW	FLS	FRS	FD291	DF921	W	PW	
300 SEF FORK SACHS	300	14	FD138	1	DF772	FLW	FLS	FRS	FD291	DF921	W	PW	
300 SEF FORK WP	300	14	FD138	1	DF920	FLW	FLS	FRS	FD291	DF921	W	PW	
300 SEF-R FORK SACHS	300	14	FD138	1	DF772	FLW	FLS	FRS	FD291	DF921	W	PW	
300 SEF-R FORK WP	300	14	FD138	1	DF920	FLW	FLS	FRS	FD291	DF921	W	PW	
SE 3.0	300	10	11	FD138	1	DF772	FLW		FD093	DF670	W	PW	
SE 3.0i	300	12	13	FD138	1	DF772	FLW		FD291	DF670	W	PW	
SE-R 3.0 ISDE	300	14		FD138	1	DF772	FLW	FLS	FRS	FD291	DF921	W	PW
ST 3.0	300	13		FD446	1	DF808	W		FD224	DF809	W	PW	
305 ST	305	15		FD223	1	DF808	W		FD224	DF809	W	PW	
3.2 4T	320	05		FD223	1	DF808	W		FD224	DF809	W	PW	
4.5 4T	450	04	08	FD138	1	DF772	FLW		FD093	DF670	W	PW	
4.5 4T SM	450	05	08	FD068	1				FD093	DF670	W	PW	
4.5 4T SM if	450	09		FD262	1				FD093	DF670	W	PW	
4.5 if	450	09		FD138	1	DF772	FLW		FD093	DF670	W	PW	
4.5 SEF-R ISDE	450	15		FD138	1	DF772	FLW	FLS	FRS	FD291	DF921	W	PW
450 SEF FORK SACHS	450	15		FD138	1	DF772	FLW	FLS	FRS	FD291	DF921	W	PW
450 SEF FORK WP	450	15		FD138	1	DF920	FLW	FLS	FRS	FD291	DF921	W	PW
450 SEF-R FORK SACHS	450	15		FD138	1	DF772	FLW	FLS	FRS	FD291	DF921	W	PW
450 SEF-R FORK WP	450	15		FD138	1	DF920	FLW	FLS	FRS	FD291	DF921	W	PW
SE 4.5i	450	12	13	FD138	1	DF772	FLW		FD291	DF670	W	PW	
5.1 4T	510	06	08	FD138	1	DF772	FLW		FD093	DF670	W	PW	
5.1 if	510	09		FD138	1	DF772	FLW		FD093	DF670	W	PW	
SE 5.1i	510	12	13	FD138	1	DF772	FLW		FD291	DF670	W	PW	
SIAMOTO													
BIRDIE	50	99		FD094	1	DF466	W		MF	-			
CAPRI	50	99		FD065	1				FD065				
FALKON	50	99		FD065	1				FD065				
MAT	50	99		FD136	1	DF466	W		MF	-			
SCROSS	50	99		FD084	1				MF	-			
TOP RACING	50	99		FD094	1	DF037	W	RW	FLS	MF	-		
MAT	100	99		FD094	1	DF037	W	RW	FLS	MF	-		
TOP RACING	100	99		FD094	1	DF037	W	RW	FLS	MF	-		
CAPRI	125	99		FD065	1				FD065				
FALKON	125	99		FD065	1				FD065				
CAPRI	180	99		FD065	1				FD065				
SIGMA COLOMBIA													
SG 100 SA	100			FD252	1				MF	-			
GLOUD 110-3	110			FD073	1				MF	-			
SG 125-4	125			FD393	1				MF	-			
SG 125-5	125			FD252	1				MF	-			
SG 125-2A	125			FD073	1				MF	-			
150-6Y	150			FD214	1				MF	-			
SG 150-4	150			FD393	1				MF	-			
SG 150-8	150			FD252	1				MF	-			
SG 150-9	150			FD073	1				MF	-			
SG 150-6Y	150			FD					FD073				
SG 150 TE	150			FD073	1				MF	-			
SILENCE													
S01	EL	20		FD546	1				FD548				
S02 LS	EL	20		FD547	1				FD548				
SIMSON													
50 SR XCE	50	94		FD071	1				MF	-			
53 S OR, B, N	53	94		FD071	1				MF	-			
80 XC, XCE	80	94		FD071	1				MF	-			
ALL MODELS	80	95		FD071	1				MF	-			
83 S OR, B	83	94		FD071	1				MF	-			
SKYGO COLOMBIA													
SG 125S	125			FD073	1				MF	-			
SG 200-2	200			FD					FD169				
SUMCO													
JUNIOR CROSS 90	90	06		FD065	1				MF	-			
DINGO DG 110	110	06		FD094	1				MF	-			
125 KR	125	05		FD162	1				FD065				
125 ST	125	05		FD266	1				MF	-			
KIRA KR 125 SM	125	06		FD162	1				FD065				
KIRA KR 125 TR	125	06		FD162	1				FD065				
MS 125	125	06		FD169	1				FD214				
MS 150	150	06		FD169	1				FD214				
200 KR	200	05		FD162	1				FD065				
KIRA KR 200 TR	200	06		FD162	1				FD065				
250 TWIN	250	05		FD266	1				MF	-			



BRAND & MODEL · MARCA Y MODELO MARCA E MODELLO · MARQUE ET MODÈLE	C.C.	YEAR	FRONT					REAR				KITS KG	
			FD _{MF}	N°	DF	OE	UPGRADE 1	UPGRADE 2	FD _{MF}	DF	OE		UPGRADE
SUZUKI													
ADDRESS	50	92	94	MF301		-				MF301	-		
ADDRESS	50	95		FD153	1	DF308				MF301	-		
AH 50 ADDRESS	50	94		FD094	1	DF308				MF301	-		
AJ ZZ SEPIA	50	93		FD094	1					MF301	-		
AP 50	50	94		FD153	1	DF308				MF301	-		
DR 50 LC	50	94		FD065	1					MF608	-		
ESTILLETE UF 50	50	00		FD153	1					MF	-		
KATANA 50	50	97	98	FD153	1	DF308				MF301	-		
KATANA 50 DD	50	99		FD153	1	DF308				FD065			
R7 ADDRESS 50	50	96		FD153	1	DF308				MF301	-		
RF 50	50	95		FD153	1	DF308				MF301	-		
RMX 50	50	96		FD065	1					FD065			
SMX 50	50	00		FD065	1					FD065			
TR 50 STREET MAGIC	50	98		FD177	1	DF308				MF	-		
ZILLION 50	50	99		FD065	1	DF308				MF301	-		
ZZ 50	50	94		FD094	1					MF301	-		
RM 65	65	03		FD254	1	DF195	W			FD095	DF195	W	
AH 75	75	92		MF302		-				MF302	-		
AH 80 ADDRESS	80	92		FD094	1					MF301	-		
CP ADDRESS	80	92		FD094	1					MF301	-		
DR 80 BIG	80	91		FD090	1					FD114			
RM 80	80	90	95	FD094	1					FD094	DF165	W	
RM 80	80	96	02	FD177	1	DF353	W			FD094	DF165	W	
RM 85 / L	85	03	04	FD177	1	DF353	W			FD094	DF165	W	
RM 85 / L	85	05		FD204	1	DF489	W			FD362	DF329	W	
ADDRESS	100	95		FD153	1					MF	-		
AH 100 ADDRESS	100	94	94	FD094	1					MF	-		
ADDRESS 110	110	15	17	FD094	1					MF	-		
ADDRESS 110	110	18		FD504	1					MF	-		
HOKUTO UG 110	110	00		FD177	1					MF	-		
ADDRESS 125	125	09		FD117	1					MF	-		
AN VECSTAR	125	95		FD177	1					MF301	-		
DR 125 S	125	93	97	FD076	1					MF151	-		
DR 125 S	125	98		FD095	1					MF151	-		
DR 125 SE	125	94		FD076	1					MF151	-		
DR 125 SM	125	08		FD164	1					FD093			
DR-Z 125 L	125	03		FD177	1					MF	-		
EN 125	125	05		FD086	1					MF151	-		
EPICURO 125	125	99		FD177	1					MF	-		
GN 125	125	93		FD075	1					MF151	-		
GSX R 125	125	17		FD298	1	DF332	W			FD500			
GSX S 125	125	17		FD298	1	DF332	W			FD500			
GZ 125 MARAUDER	125	98		FD209	1					MF	-		
RG 125 F	125	93	97	FD107	1	DF321	CW	CRW		FD120	DF312	W	
RGV 125 AIR COOLED	125	98		FD075	1					MF	-		
RGV 125 WATER COOLED	125	98		FD117	1					MF	-		
RM 125	125	96	98	FD164	1	DF301	FLW	FLS	FRS	FD093	DF302	W	
RM 125	125	99	03	FD164	1	DF301	FLW	FLS	FRS	FD093	DF338	W	
RM 125	125	04	05	FD164	1	DF301	FLW	FLS	FRS	FD286	DF338	W	
RM 125	125	06		FD164	1	DF301	FLW	FLS	FRS	FD286	DF354	W	
RV 125 VAN VAN	125	03		FD179	1	DF374	W			MF	-		
SHOGUN R	125	05		FD145	1					MF	-		
SIXTEEN	125	08		FD344	1	DF365	W			FD315	DF365	W	
TS 125 R	125	90		FD086	1					FD114			
TU 125	125	00		FD209	1					MF151	-		
UE 125	125	01		FD094	1					MF	-		
UH 125 BURGMAN	125	02	06	FD138	1	DF318	W			FD220	DF319	W	
UH 125 BURGMAN	125	07	13	FD344	1	DF364	W			FD315	DF364	W	
UH 125 BURGMAN R	125	11		FD344	1	DF364	W			FD315	DF364	W	
UH 125 BURGMAN	125	14		FD117	1	DF364	W			FD315	DF364	W	
UH 125 BURGMAN ABS	125	14		FD117	1	DF364	W			FD315	DF364	W	
VL 125 MARAUDER	125	00		FD209	1					MF	-		
AN VECSTAR	150	98		FD177	1					MF301	-		
AVENIS 150	150	99		FD177	1					MF	-		
EPICURO 150	150	99		FD177	1					MF	-		
SIXTEEN	150	08		FD344	1	DF365	W			FD315	DF365	W	
UH 150 BURGMAN	150	02		FD138	1	DF318	W			FD220	DF319	W	
RG 200 GAMMA	200	92		FD107	1					FD111			
RG 200 WOLF	200	92		FD090	1					FD111			
RV 200 VAN VAN	200	03		FD179	1	DF374	W			MF	-		
UH 200 BURGMAN	200	07	13	FD344	1	DF364	W			FD315	DF364	W	
UH 200 BURGMAN	200	14		FD117	1	DF364	W			FD315	DF364	W	

APPLICATIONS
 PADS FD
 DISCS DF
 SHOES MF
 LINES FK
 BRACKETS SP
 KITS KG
 CROSS REFERENCE



APPLICATIONS

PADS FD

DISCS DF

SHOES MF

LINES FK

BRACKETS SP

KITS KG

CROSS REFERENCE

BRAND & MODEL • MARCA Y MODELO MARCA E MODELLO • MARQUE ET MODÈLE	C.C.	YEAR	FRONT					REAR				KITS KG
			FD	N°	DF	OE	UPGRADE 1	UPGRADE 2	FD	DF	OE	
continue SUZUKI												
UH 200 BURGMAN ABS	200	14	FD117	1	DF364	W			FD315	DF364	W	
AN 250 BURGMAN	250	98 02	FD222	1	DF341	W			FD400	DF342	W	
AN 250 BURGMAN	250	03 06	FD222	1	DF344	W			FD400			
AN 250 BURGMAN / SKY WAVE DER.	250	07 08	FD145	2	DF331	FLW						
AN 250 BURGMAN / SKY WAVE IZQ.	250	07 08	FD187	2	DF331	FLW			FD400	DF360	W	
CJ 250 SKY WAVE / Type S	250	03	FD222	1	DF344	W			FD401			
BANDIT 250	250	90	FD090	1					FD045	DF316	W	
DR 250 S	250	90 00	FD086	1	DF306	W			FD114			
DR 250 SB	250	03	FD164	1	DF150	FLW			FD093	DF152	W	
DR-Z 250 E	250	01	FD164	1	DF301	FLW			FD093			
GEMMA 250 (JAP)	250	09	FD140	1					FD401			
GN 250	250	93	FD046	1					MF151	-		
GSX 250 FX	250	02	FD179	1	DF167	CW			FD167			
GSX 250 R	250	17	FD266	1					FD134			
GW 250 INAZUMA	250	12 14	FD266	1					FD457			
GW 250 INAZUMA F	250	15	FD266	1					FD457	DF352	W	
GW 250 INAZUMA S	250	13 14	FD266	1					FD457			
GW 250 INAZUMA Z	250	15	FD266	1					FD457	DF352	W	
GZ 250 MARAUDER	250	98 07	FD209	1					MF	-		
GZ 250 MARAUDER	250	08	FD209	1					MF	-		
INTRUDER LC 250	250	00	FD209	1					MF	-		
RGV 250 GAMMA	250	91 96	FD107	2	DF321	CW	CRW		FD104	DF312	W	
RM 250	250	93 95	FD086	1	DF301	FLW	FLS	FRS	FD114	DF302	W	
RM 250	250	96 98	FD164	1	DF301	FLW	FLS	FRS	FD093	DF302	W	
RM 250	250	99 03	FD164	1	DF301	FLW	FLS	FRS	FD093	DF338	W	
RM 250	250	04 05	FD164	1	DF301	FLW	FLS	FRS	FD093	DF338	W	
RM 250	250	06	FD164	1	DF301	FLW	FLS	FRS	FD093	DF354	W	
RM 250 Z	250	04 06	FD164	1	DF182	FLW	FLS	FRS	FD286	DF179	W	WLL
RM 250 Z	250	07 12	FD164	1	DF349	FLW	FLS	FRS	FD286	DF350	W	WLL
RM 250 Z	250	13	FD164	1	DF349	FLW	FLS	FRS	FD286	DF350	W	WLL
RMX S	250	92 94	FD086	1	DF301	FLW	FLS	FRS	FD114	DF302	W	
RMX 250	250	95	FD086	1	DF301	FLW	FLS	FRS	FD114	DF302	W	
TU 250 GRASSTRACKER/BIG BOY	250	00	FD174	1					MF	-		
TU 250 X	250	97 01	FD209	1					MF151	-		
TU 250 X	250	02	FD174	1					MF151	-		
V-STROM 250	250	17	FD266	1					FD134			
VL 250 MARAUDER	250	00	FD209	1					MF	-		
DR 350 S	350	90 92	FD086	1	DF306	W			FD114			
DR 350 S, SH	350	93 93	FD086	1	DF306	W			FD114			
DR 350 SE	350	94	FD086	1	DF306	W			FD114			
GOOSE 350	350	92	FD107	1					FD111			
AN 400 BURGMAN	400	98 02	FD222	1	DF341	W			FD400	DF342	W	
AN 400 BURGMAN	400	03 05	FD222	1	DF344	W			FD400			
AN 400 BURGMAN IZQ./LEFT	400	06	FD187	1	DF344	W						
AN 400 BURGMAN DER./RIGHT	400	06	FD145	1	DF344	W			FD401			
AN 400 SKY WAVE IZQ./LEFT	400	07	FD187	1	DF344	W						
AN 400 SKY WAVE DER./RIGHT	400	07	FD145	1	DF344	W			FD401			
BOULEVARD 400	400	05	FD179	1					MF	-		
CK SKY WAVE 400	400	03	FD222	1	DF344	W			FD400			
DR-Z 400 E	400	00	FD164	1	DF301	FLW			FD093	DF302	W	
DR-Z 400 S	400	00	FD164	1	DF301	FLW			FD093	DF302	W	
DR-Z 400 S SUPER MOTARD	400	05	FD164	1					FD093	DF338	W	
GS 400 E	400	91	FD090	1					FD045			
GSR 400	400	06	FD107	2	DF351	CW	CRW		FD359	DF352	W	
GSX 400 F BANDIT	400	90	FD090	1	DF314	CW			FD111	DF316	W	
GSX 400 IMPULSE (Japan)	400	94 98	FD266	2	DF317	CW			FD045	DF316	W	
GSX 400 IMPULSE (Japan)	400	99	FD176	2	DF317	CW			FD045	DF316	W	
GSX 400 INAZUMA	400	00	FD176	2	DF317	CW			FD111	DF307	W	
GSX 400 S KATANA	400	92	FD107	2					FD111			
GSX R 400	400	90	FD090	2					FD045			
GSX R 400 R	400	90	FD099	2	DF321	CW	CRW		FD045	DF312	W	
RF 400 R	400	93	FD266	2	DF317	CW			FD045	DF307	W	
SFV 400 GLADIUS LEFT/IZQ	400	10	FD174	2	DF337	CW						
SFV 400 GLADIUS RIGHT/DER	400	10	FD179	2	DF337	CW			FD103	DF307	W	
SV 400 /S DER.	400	99	FD179	2	DF317	CW						
SV 400 /S IZ.	400	99	FD174	2	DF317	CW			FD111	DF307	W	
VS 400 INTRUDER	400	94	FD066	1					MF	-		
RM 450 Z	450	05	FD164	1	DF349	FLW	FLS	FRS	FD286	DF350	W	WLL
RMX 450 Z	450	10 17	FD164	1	DF349	FLW	FLS	FRS	FD286	DF350	W	WLL
RMX 450 Z	450	18	FD164	1	DF368	FLW	FLS	FRS	FD286	DF350	W	WLL
GS 500 E	500	96	FD179	1	DF314	CW			FD111	DF316	W	
GS 500 F	500	06	FD179	1	DF314	CW			FD111	DF316	W	



BRAND & MODEL · MARCA Y MODELO MARCA E MODELLO · MARQUE ET MODÈLE	C.C.	YEAR	FRONT						REAR				KITS KG
			FD _{MF}	N°	DF	OE	UPGRADE 1	UPGRADE 2	FD _{MF}	DF	OE	UPGRADE	
continue SUZUKI													
GSF 600 N BANDIT	600	95	99	FD266	2	DF317	CW			FD111	DF307	W	
GSF 600 N BANDIT DER.	600	00		FD179	2	DF317	CW						
GSF 600 N BANDIT IZQ.	600	00		FD174	2	DF317	CW			FD111	DF307	W	
GSR 600	600	06		FD107	2	DF351	CW	CRW		FD359	DF352	W	
GSX 600 F	600	91	97	FD109	2	DF317	CW			FD111	DF316	W	
GSX 600 F DER. (KATANA 600 USA)	600	98	03	FD179	2	DF317	CW						
GSX 600 F IZQ. (KATANA 600 USA)	600	98	03	FD174	2	DF317	CW			FD111	DF307	W	
GSX 600 F DER. (KATANA 600 USA)	600	04		FD179	2	DF337	CW						
GSX 600 F IZQ. (KATANA 600 USA)	600	04		FD174	2	DF337	CW			FD111	DF307	W	
GSX 600 R	600	92	96	FD099	2					FD045			
GSX R 600 SRAD	600	97	03	FD107	2	DF320	CW	CRW		FD111	DF339	W	
GSX R 600 SRAD	600	04	05	FD325	2	DF322	CW	CRW		FD267	DF339	W	
GSX R 600	600	06	07	FD325	2	DF348	CW	CRW		FD359	DF339	W	
GSX R 600	600	08	10	FD325	2	DF358	CW	CRW		FD359	DF339	W	
GSX R 600	600	11		FD373	2	DF358	CW	CRW		FD363	DF339	W	
RF 600 R	600	93		FD266	2	DF317	CW			FD111	DF307	W	
VS 600 GL INTRUDER	600	95		FD066	1					MF	-		
AN 650 BURGMAN	650	02	03	FD266	2	DF330	W			FD401			
AN 650 BURGMAN	650	04	12	FD266	2	DF331	FLW			FD401	DF363	W	
AN 650 BURGMAN	650	13		FD266	2	DF344	W			FD401	DF363	W	
CP SKY WAVE 650	650	03	03	FD266	2	DF330	W			FD401			
CP SKY WAVE 650	650	04		FD266	2	DF344	W			FD401			
DL 650 V-STROM DER.	650	04	06	FD179	2	DF323	CW	CRW					
DL 650 V-STROM IZQ.	650	04	06	FD174	2	DF323	CW	CRW		FD134	DF361	W	
DL 650 V-STROM DER.	650	07		FD179	2	DF351	CW	CRW					
DL 650 V-STROM IZQ.	650	07		FD174	2	DF351	CW	CRW		FD134	DF361	W	
DL 650 V-STROM DER./ABS	650	07		FD179	2	DF351	CW	CRW					
DL 650 V-STROM IZQ./ABS	650	07		FD174	2	DF351	CW	CRW		FD134	DF361	W	
DL 650 V-STROM XPEDITION DER.	650	11		FD179	2	DF351	CW	CRW					
DL 650 V-STROM XPEDITION IZQ.	650	11		FD174	2	DF351	CW	CRW		FD134	DF361	W	
DL 650 V-STROM XPEDITION DER./ABS	650	11	12	FD179	2	DF351	CW	CRW					
DL 650 V-STROM XPEDITION IZQ./ABS	650	11	12	FD174	2	DF351	CW	CRW		FD134	DF361	W	
DL 650 V-STROM XPEDITION DER./ABS	650	13	13	FD179	2	DF351	CW	CRW					
DL 650 V-STROM XPEDITION IZQ./ABS	650	13	13	FD174	2	DF351	CW	CRW		FD134	DF361	W	
DL 650 V-STROM XT DER./ABS	650	15		FD179	2	DF351	CW	CRW					
DL 650 V-STROM XT IZQ./ABS	650	15		FD174	2	DF351	CW	CRW		FD134	DF361	W	
DR 650 R, RS	650	90	91	FD101	1	DF304				FD120			
DR 650 RL, RM, RSL	650	91	91	FD101	1	DF315	W			FD120			
DR 650 RSE	650	92	93	FD101	1	DF315	W			FD120			
DR 650 RE	650	94	95	FD101	1	DF315	W			FD120			
DR 650	650	96		FD164	1	DF327	FLW			FD114	DF328	W	
GSF 650 BANDIT /S DER.	650	05	05	FD179	2	DF337	CW						
GSF 650 BANDIT /S IZQ.	650	05	05	FD174	2	DF337	CW			FD267	DF307	W	
GSF 650 BANDIT /S/ ABS DER.	650	06		FD179	2	DF351	CW	CRW					
GSF 650 BANDIT /S/ ABS IZQ.	650	06		FD174	2	DF351	CW	CRW		FD134	DF352	W	
GSF 650 BANDIT /S/	650	07		FD107	2	DF351	CW	CRW		FD134	DF352	W	
GSF 650 BANDIT /S/ ABS	650	07		FD107	2	DF351	CW	CRW		FD134	DF352	W	
GSX 650 F	650	08		FD107	2	DF351	CW	CRW		FD134	DF352	W	
LS 650 SAVAGE	650	90	91	FD209	1					MF	-		
LS 650 P	650	92	04	FD209	1					MF	-		
LS 650 (S40 BOULEVAR USA)	650	05	08	FD209	1					MF	-		
LS 650 (S40 BOULEVAR USA)	650	09		FD209	1					MF	-		
SFV 650 GLADIUS LEFT/IZQ	650	09		FD174	2	DF334	CW						
SFV 650 GLADIUS RIGHT/DER	650	09		FD179	2	DF334	CW			FD457	DF352	W	
SFV 650 GLADIUS ABS LEFT/IZQ	650	10		FD174	2	DF334	CW						
SFV 650 GLADIUS ABS RIGHT/DER	650	10		FD179	2	DF334	CW			FD457	DF352	W	
SV 650	650	19		FD107	2	DF334	CW			FD457	DF352	W	
SV 650 /S DER.	650	99	02	FD179	2	DF317	CW						
SV 650 /S IZQ.	650	99	02	FD174	2	DF317	CW			FD111	DF307	W	
SV 650 /S DER.	650	03	03	FD179	2	DF337	CW						
SV 650 /S IZQ.	650	03	03	FD174	2	DF337	CW			FD457	DF339	W	
SV 650 /S DER.	650	04	06	FD179	2	DF337	CW						
SV 650 /S IZQ.	650	04	06	FD174	2	DF337	CW			FD457	DF339	W	
SV 650 ABS DER.	650	07		FD179	2	DF334	CW						
SV 650 ABS IZQ.	650	07		FD174	2	DF334	CW			FD457	DF352	W	
SV 650 X DER.	650	18		FD179	2	DF334	CW						
SV 650 X IZQ.	650	18		FD174	2	DF334	CW			FD457	DF352	W	
XF 650 FREEWIND	650	97		FD179	1	DF315	W			FD103	DF328	W	
GSR 750 LEFT/IZQ	750	11		FD174	2	DF351	CW	CRW					
GSR 750 RIGHT/DER	750	11		FD179	2	DF351	CW	CRW		FD134	DF352	W	
GSR 750 ABS LEFT/IZQ	750	11		FD174	2	DF351	CW	CRW					
GSR 750 ABS RIGHT/DER	750	11		FD179	2	DF351	CW	CRW		FD134	DF352	W	





APPLICATIONS

PADS

DISCS

SHOES

LINES

BRACKETS

KITS

CROSS REFERENCE

BRAND & MODEL · MARCA Y MODELO MARCA E MODELLO · MARQUE ET MODÈLE	C.C.	YEAR	FRONT						REAR				KITS
				N°		OE	UPGRADE 1	UPGRADE 2			OE	UPGRADE	
continue SUZUKI													
GSX 750 F DER.	750	98	FD179	2	DF321	CW	CRW						
GSX 750 F IZQ	750	98	FD174	2	DF321	CW	CRW	FD111	DF307	W			
GSX 750 F VS DER. (KATANA 750 USA)	750	99	02	FD179	2	DF317	CW						
GSX 750 F VS IZQ. (KATANA 750 USA)	750	99	02	FD174	2	DF317	CW		FD111	DF307	W		
GSX 750 F DER.	750	03		FD174	2	DF337	CW						
GSX 750 F IZQ	750	03		FD179	2	DF337	CW		FD111	DF307	W		
GSX R 750 L, LM, W	750	91	93	FD099	2	DF690	CW	CRW	FD111	DF307	W		
GSX R 750 W	750	94	95	FD156	2	DF690	CW	CRW	FD111	DF307	W		
GSX R 750 SRAD	750	96	99	FD156	2	DF320	CW	CRW	FD111	DF339	W		
GSX R 750 SRAD	750	00	03	FD107	2	DF320	CW	CRW	FD111	DF339	W		
GSX R 750 SRAD	750	04	05	FD325	2	DF322	CW	CRW	FD267	DF339	W		
GSX R 750	750	06	07	FD325	2	DF348	CW	CRW	FD359	DF339	W		
GSX R 750	750	08	10	FD325	2	DF358	CW	CRW	FD359	DF339	W		
GSX R 750	750	11		FD373	2	DF358	CW	CRW	FD363	DF339	W		
GSX S 750	750	17		FD331	2	DF351	CW		FD134				
BOULEVARD 800	800	05		FD179	1				MF	-			
DR 800 S, SL BIG	800	90	91	FD101	1	DF315	W		FD120				
DR 800 S BIG	800	92		FD090	1	DF315	W		FD117				
VL 800 VOLUSIA	800	01		FD179	1				MF	-			
VS 800 GL	800	93		FD066	1				MF	-			
VS 800 GL, INTRUDER	800	91	92	FD078	1				MF	-			
VS 800 GL, N, INTRUDER	800	93	99	FD066	1				MF	-			
VS INTRUDER M 800	800	05		FD179	1				MF	-			
VX 800	800	90		FD090	1	DF335			FD022	DF336			
VZ 800 MARAUDER	800	97		FD179	1	DF321	CW	CRW	MF	-			
ZX 800	800	92		FD090	1				FD022				
RF 900 R	900	94	95	FD099	2	DF314	CW		FD189	DF307	W		
RF 900 RS2	900	96		FD099	2	DF690	CW	CRW	FD189	DF307	W		
DL 1000 V-STROM DER.	1000	01	13	FD179	2	DF323	CW	CRW					
DL 1000 V-STROM IZQ.	1000	01	13	FD174	2	DF323	CW	CRW	FD134	DF361	W		
DL 1000 V-STROM ABS	1000	14		FD325	2	DF351	CW	CRW	FD359	DF361	W		
DL 1000 V-STROM XT ABS	1000	17		FD325	2	DF351	CW	CRW	FD359	DF361	W		
GSX-S 1000 ABS	1000	15		FD373	2	DF371	CW		FD134	DF372	W		
GSX-S 1000 F ABS	1000	15		FD373	2	DF371	CW		FD134	DF372	W		
GSX-S 1000 KATANA	1000	19		FD373	2	DF371	CW		FD134	DF372	W		
GSX R 1000	1000	01	02	FD156	2	DF320	CW	CRW	FD267	DF339	W		
GSX R 1000	1000	03	03	FD290	2	DF322	CW	CRW	FD267	DF339	W		
GSX R 1000	1000	04	04	FD325	2	DF322	CW	CRW	FD267	DF339	W		
GSX R 1000	1000	05	06	FD325	2	DF348	CW	CRW	FD267	DF339	W		
GSX R 1000	1000	07	08	FD325	2	DF348	CW	CRW	FD359	DF339	W		
GSX R 1000	1000	09	11	FD325	2	DF358	CW	CRW	FD363	DF339	W		
GSX R 1000	1000	12	15	FD373	2	DF358	CW	CRW	FD363	DF339	W		
GSX R 1000	1000	16		FD373	2	DF325	CW		FD363	DF370	W		
GSX R 1000 R	1000	16		FD373	2	DF325	CW		FD363	DF370	W		
SV 1000	1000	03		FD107	2	DF323	CW	CRW	FD134	DF339	W		
SV 1000 / S / SZ	1000	03		FD107	2	DF323	CW	CRW	FD134	DF339	W		
TL 1000 R	1000	98		FD156	2	DF320	CW	CRW	FD111	DF339	W		
TL 1000 S	1000	97		FD107	2	DF320	CW	CRW	FD111	DF339	W		
DL 1050 V-STROM	1050	20		FD325	2	DF351	CW	CRW	FD359	DF361	W		
DL 1050 V-STROM XT	1050	20		FD325	2	DF351	CW	CRW	FD359	DF361	W		
GSX 1100 G	1100	90	92	FD090	2				FD022				
GSX 1100 G	1100	93		FD090	2	DF333			FD111				
GSX 1100 KATANA	1100	02		FD156	2				FD267				
GSX R 1100 W	1100	93		FD156	2	DF690	CW	CRW	FD111	DF307	W		
GS 1200 SS	1200	01		FD156	2	DF314	CW		FD267	DF307	W		
GSF 1200 BANDIT	1200	95	99	FD099	2	DF314	CW		FD111	DF307	W		
GSF 1200 BANDIT / S	1200	00	05	FD156	2	DF314	CW		FD111	DF307	W		
GSF 1200 BANDIT / S	1200	06		FD107	2	DF351	CW	CRW	FD134	DF352	W		
GSF 1200 BANDIT ABS	1200	06		FD107	2	DF351	CW	CRW	FD134	DF352	W		
GSX 1200	1200	99		FD176	2	DF314	CW		FD111				
INAZUMA 1200	1200	98		FD176	2	DF314	CW		FD111	DF307	W		
GSF 1250 BANDIT A/S/SA	1250	07	08	FD107	2	DF351	CW	CRW	FD134	DF352	W		
GSF 1250 BANDIT FA	1250	09		FD107	2	DF351	CW	CRW	FD134	DF352	W		
GSF 1250 BANDIT /SA	1250	10		FD107	2	DF351	CW	CRW	FD134	DF352	W		
B-KING	1300	07		FD331	2	DF351	CW	CRW	FD359	DF355	W		
GSX 1300 R HAYABUSA	1300	99	07	FD156	2	DF320	CW	CRW	FD111	DF307	W		
GSX 1300 R HAYABUSA	1300	08	13	FD325	2	DF351	CW	CRW	FD359	DF355	W		
GSX 1300 R HAYABUSA	1300	14		FD373	2	DF351	CW	CRW	FD359	DF355	W		
GSX 1400	1400	01		FD156	2	DF320	CW	CRW	FD267	DF346	W		
VS 1400 GLP	1400	92		FD078	1				FD111				
VS 1400 (S83 USA)	1400	04		FD078	1				FD078				
M 1500 LEFT/IZQ	1500	09		FD174	2								



BRAND & MODEL · MARCA Y MODELO MARCA E MODELLO · MARQUE ET MODÈLE	C.C.	YEAR	FRONT					REAR				KITS KG	
			FD _{MF}	N°	DF	OE	UPGRADE 1	UPGRADE 2	FD _{MF}	DF	OE		UPGRADE
continue SUZUKI													
M 1500 RIGHT/DER	1500	09	FD179	2						FD179			
VL 1500 INTRUDER LEGENDARY EASSIC	1500	98 99	FD066	1						FD083			
VL 1500 INTRUDER LEGENDARY CLASSIC	1500	00 01	FD066	1						FD083			
VL 1500 INTRUDER LEFT/IZQ	1500	02	FD174	2									
VL 1500 INTRUDER RIGHT/DER	1500	02	FD179	2						FD107			
VL 1500 INTRUDER T	1500	13	FD140	1						FD179			
TL 1600 S	1600	97	FD107	2						FD111			
VZ 1600	1600	04	FD156	2						FD179			
VZ 1600 INTRUDER	1600	05	FD290	2						FD179			
INTRUDER C 1800 R	1800	08 11	FD344	2	DF337	CW	CRW			FD179			
INTRUDER C 1800 RT	1800	08 09	FD344	2	DF337	CW	CRW			FD179			
M 109 R BOULEVARD	1800	06	FD325	2	DF348	CW	CRW			FD179	DF359	CW	
M 1800 RB	1800	14	FD325	2	DF348	CW	CRW			FD179			
VL 1800 VOLUSIA	1800	02	FD179	1						MF	-		
VZR 1800 INTRUDER	1800	06 07	FD325	2	DF348	CW	CRW			FD179	DF359	CW	
VZR 1800 INTRUDER	1800	08	FD344	2	DF348	CW	CRW			FD179	DF359	CW	
SUZUKI 4 Wheels													
LT F-160 M/N/P	160	91 93	MF		-					MF323	-		
LT 250 F OZARK	250	02	FD095	2						MF	-		
LT F-4WDXM/N/P	250	91 93	MF342		-					MF331	-		
LT Z-250 K4 QUAD SPORT	250	04	FD095	2						MF	-		
LTF 300 DER.	300	02	FD117	2						MF321	-		
LTF 300 IZQ.	300	02	FD086	2						MF321	-		
LT A 400 DER. KING QUAD	400	08	FD315	2						MF	-		
LT A 400 IZQ. KING QUAD	400	08	FD318	2						MF	-		
LT A-400	400	02	FD095	2						MF	-		
LT F 400 DER. KING QUAD	400	08	FD315	2						MF	-		
LT F 400 IZQ. KING QUAD	400	08	FD318	2						MF	-		
LT Z 400	400	03	FD076	2	DF894	W				FD076	DF048	W	
LTF 400 EGER	400	02 07	FD095	2						MF	-		
LT A 450 LEFT/IZQ.	450	07	FD319	2									
LT A 450 RIGHT/DER.	450	07	FD321	2						FD			
LT R 450 LEFT/IZQ.	450	06	FD086	2	DF733	W							
LT R 450 RIGHT/DER.	450	06	FD117	2	DF733	W				FD076	DF734	W	
LT 500 RH,RJ,RK,RL,RM,RN	500	91 93	FD075	2									
LT F 500 VINSON	500	09	FD095	2						FD			
LT-F/A 500 F QUADRUNNER LEFT/IZQ.	500	98 02	FD086	2						FD318			
LT-F/A 500 F QUADRUNNER RIGHT/DER.	500	98 02	FD117	2									
LT-A 700 KING QUAD LEFT/IZQ.	700	05	FD315	2									
LT-A 700 KING QUAD RIGHT/DER.	700	05	FD318	2						MF	-		
LT-V 700 TWIN PEAKS LEFT/IZQ.	700	04	FD319	2									
LT-V 700 TWIN PEAKS RIGHT/DER.	700	04	FD321	2						MF	-		
SWM													
RS 125 R	125	16	FD138	1	DF635	W				FD291	DF670	W	
SM 125 R	125	16	FD172	1	DF635	W				FD165	DF670	W	
MC 250 S	250	16	FD138	1	DF635	W				FD291	DF670	W	
FT 300 R	300	16	FD138	1	DF635	W				FD291	DF670	W	
RS 300 R	300	16	FD138	1	DF635	W				FD291	DF670	W	
RS 340 S	340	16	FD138	1	DF635	W				FD291	DF670	W	
V4 REZ 400	400	20	FD475	1						FD165			
GRAN MILANO	440	16	FD262	1						FD165	DF885	W	
GRAN TURISMO	440	15	FD266	1						FD165			
SILVER VASE	440	16	FD172	1						FD165	DF885	W	
SM 450 R	450	15	FD262	1						FD291		W	
ACE OF SPADES	500	20	FD262	1						FD165	DF670	W	
OUTLAW	500	20	FD262	1						FD165	DF670	W	
RS 500 R	500	16	FD138	1	DF635	W				FD291	DF670	W	
SM 500 R	500	16	FD262	1	DF645	W				FD291	DF670	W	
MC 650 R	650	18	FD138	1	DF635	W				FD291	DF885	W	
RS 650 R	650	16	FD138	1	DF635	W				FD165	DF885	W	
SM 650 R	650	16	FD262	1	DF645	W				FD165	DF670	W	
SUPER DUAL	650	16	FD172	1	DF645	W				FD165	DF885	W	
SUPER DUAL GT	650	16	FD172	1	DF645	W				FD165	DF885	W	
SYM													
EVIE	EL	10	MF002		-					MF002	-		
SYMMETRY	EL	11	MF002		-					MF002	-		
WOO	EL	11	FD113	1						MF002	-		
CHA CHA	50	99	FD149	1						MF	-		
CINDERELLA	50	99	FD113	1						MF	-		
DD 50	50	04	FD113	1						MF	-		
FIDDLE 50	50	08	FD188	1	DF037	W				MF	-		
FIDDLE III 50	50	15	FD188	1	DF037	W				MF	-		

APPLICATIONS

PADS FD

DISCS DF

SHOES MF

LINES FK

BRACKETS SP

KITS KG

CROSS REFERENCE





APPLICATIONS

PADS FD

DISCS DF

SHOES MF

LINES FK

BRACKETS SP

KITS KG

CROSS REFERENCE

BRAND & MODEL · MARCA Y MODELO MARCA E MODELLO · MARQUE ET MODÈLE	C.C.	YEAR	FRONT				REAR				KITS KG		
			FD _{MF}	N°	DF	OE	UPGRADE 1	UPGRADE 2	FD _{MF}	DF		OE	UPGRADE
continue SYM													
JET	50	99	05	FD188	1					MF	-		
JET BASI X	50	07		FD188	1					MF	-		
JET EURO X	50	05		FD188	1					MF	-		
JET SPORT X	50	06		FD188	1					FD166			
JET 4	50	10		FD188	1					MF	-		
JET 4 R	50	11		FD188	1					MF	-		
JUNGLE	50	99		FD188	1					MF630	-		
MASK /LC	50	00		FD188	1					MF630	-		
MIO 50	50	06		FD113	1					MF	-		
ORBIT 50 2T	50	15		FD188	1					MF	-		
SHARK 50	50	00		FD412	1					MF	-		
SUPER FANCY	50	99		FD149	1					MF	-		
SYMPPLY 50	50	07		FD188	1					MF	-		
SYMPHONY S 50 4T	50	15		FD188	1					FD200			
SYMPHONY SR 50 4T	50	15		FD188	1					FD200			
X PRO 50	50	13		FD145	1	DF037	W			MF002	-		
DD 100	100	04		FD113	1					MF	-		
JET EURO X 100	100	05		FD188	1					MF	-		
JET SPORT X 100 SR	100	06		FD188	1					MF	-		
MIO 100	100	06		FD113	1					MF	-		
ALLO 125	125	15		FD188	1					MF	-		
ATTILA	125	99		FD188	1					MF	-		
B9A 125	125	10		FD399	1					MF	-		
CEVALO 125	125	10		FD399	1					MF	-		
CITYCOM 125	125	09		FD188	1					FD399			
CRUISYM 125	125	18		FD275	1					FD399			
EURO MX	125	02		FD412	1					MF	-		
EURO MX DD	125	06		FD412	1					MF	-		
FIDDLE 125	125	08		FD188	1	DF037	W			MF	-		
FIDDLE III 125	125	15		FD188	1	DF037	W			MF	-		
FNX 125	125	18		FD188	1					MF	-		
GTS 125	125	07		FD399	1					FD399			
HD 2 125 CBS	125	15		FD188	1					FD399			
HD 125 EVO	125	06		FD188	1					FD399			
HUSKY	125	99		FD412	1					MF	-		
JET 4	125	10		FD188	1					MF	-		
JET 14	125	18		FD188	1					FD200			
JOYMAX 125	125	15		FD275	1					FD399			
JOYRIDE	125	01		FD412	1					FD261			
MEGALO	125	02		FD188	1					MF	-		
NEW DUKE	125	02		FD188	1					MF	-		
RS 125	125	04		FD412	1					FD145			
SB 125 WOLF	125	11		FD399	1					FD336			
SHARK 125	125	99		FD412	1					MF	-		
SUPER DUKE	125	99		FD188	1					MF	-		
SYMHT 125	125	19		FD086	1					FD075			
SYMHX 125	125	19		FD086	1					FD075			
SYMPPLY 125	125	07		FD188	1					MF	-		
SYMPHONY 125	125	09		FD188	1					MF	-		
SYMPHONY 125 S	125	10		FD188	1					FD200			
SYMPHONY 125 SR	125	10		FD188	1					FD200			
SYMPHONY 125 ST	125	16		FD188	1					FD200			
VOYAGER 125	125	05		FD092	1					FD092			
VS 125	125	06		FD412	1					MF	-		
WOLF LEGEND	125	02		FD073	1					MF	-		
WOLF SB 125 Ni	125	15		FD399	1					FD336			
X PRO 125	125	13		FD145	1	DF037	W			MF	-		
XS 125 K	125	07		FD145	1					MF	-		
EURO MX	150	02		FD412	1					MF	-		
JOYRIDE	150	01		FD412	1					FD261			
RS 150	150	06		FD412	1					FD145			
VS 150	150	06		FD412	1					MF	-		
DRG 160i	160	20		FD188	1					FD200			
VF 185	185	19		FD073	1					FD336			
H 200 SE	200	06		FD188	1					FD399			
HD 200 S EVO	200	06		FD188	1					FD399			
JOYRIDE	200	01		FD412	1					FD261			
JOYRIDE 200i EVO	200	13		FD412	1					FD261			
SYMPHONY ST 200i CBS	200	16		FD188	1					FD200			
GTS 250	250	07		FD222	1					FD399			
JOYMAX 250 i	250	07		FD275	1					FD399			
JOYMAX 250 i	250	07		FD275	1					FD399			



BRAND & MODEL · MARCA Y MODELO MARCA E MODELLO · MARQUE ET MODÈLE	C.C.	YEAR	FRONT						REAR				KITS KG
			FD _{MF}	N°	DF	OE	UPGRADE 1	UPGRADE 2	FD _{MF}	DF	OE	UPGRADE	
continue SYM													
VOYAGER 250	250	05	FD275	1						FD295			
WOLF SB 250 Ni	250	15	FD481	1						FD336			
CITYCOM 300 i	300	08	FD188	1						FD188			
CRUISYM 300	300	18	FD275	1						FD399			
JOYMAX 300 i EVO	300	09	FD275	1						FD399			
WOLF SB 300	300	15	FD399	1						FD336			
WOLF SB 300 CR	300	15	FD399	1						FD336			
MAX SYM 400i	400	11	FD481	2						FD483			
MAX SYM 400i ABS	400	14	FD481	2						FD483			
MAX SYM TL 1	400	18	FD481	2						FD483			
GT 500	500	05	FD222	1						FD261			
MAX SYM 600i ABS	600	15	FD481	2						FD483			
MAX SYM 600i SPORT ABS	600	15	FD481	2						FD483			
SYM 4 Wheels													
TRACKRUNNER 200	200	05	FD336	2						FD399			
QUADLANDER 250	250	05	FD336	2						FD336			
CITYMAX 300	300	06	FD336	2						FD399			
QUADRAIDER 600	600	06	09	FD095	2					FD336			
QUADRAIDER 600 LE	600	10	FD336	2						FD336			
T-RACE													
T-RACE C	EL	15	FD138	1						FD286			
T-RACE DIABOLICA	EL	15	FD138	1						FD291			
T-RACE E	EL	15	FD138	1						FD286			
T-RACE R	EL	15	FD138	1						FD286			
TGB													
101	50	05	FD188	1						MF453	-		
303 R	50	99	FD094	1						MF	-		
409 F	50	00	05	FD094	1					MF	-		
409 F	50	06	FD252	1						MF	-		
42 RACING 50	50	06	FD252	1						MF453	-		
AKROS 50	50	95	98	FD094	1					MF	-		
AKROS 50	50	99	FD188	1						MF	-		
DELIVERY	50	04	FD188	1						MF	-		
ERGON	50	94	FD094	1						MF	-		
PLATFORM 50	50	06	FD188	1						MF	-		
R 50 X	50	06	FD252	1						MF	-		
SUNSET 50	50	07	FD094	1						MF	-		
101	125	05	FD188	1						MF453	-		
303 R	125	99	FD094	1						MF	-		
409 F	125	02	05	FD094	1					MF	-		
409 F	125	06	FD252	1						MF453	-		
42 RACING 125	125	06	FD252	1						MF453	-		
PLATFORM 125	125	06	FD188	1						MF	-		
X - MOTION 125	125	08	FD	1						FD399	-		
101	150	05	FD188	1						MF453	-		
409 F	150	02	05	FD094	1					MF	-		
409 F	150	06	FD252	1						MF453	-		
42 RACING 150	150	06	FD252	1						MF453	-		
PLATFORM 150	150	06	FD188	1						MF	-		
SUNSET 150	150	07	FD094	1						MF	-		
X - MOTION 250i	250	08	FD	1						FD399	-		
TGB 4 Wheels													
HORNET 50	50	04	MF							FD094			
HORNET 90	90	04	MF							FD094			
101 S	100	06	FD094	2						MF453	-		
QUADBLADE 250	250	06	FD075	2						FD075			
QUADBLADE 325	325	07	FD075	2						FD094			
AVENGER 400	400	07	FD336	2						FD336			
QUADBLADE 400	400	06	FD075	2						FD117			
OUTBACK 425	425	07	FD336	2						FD336			
QUADBLADE 425	425	07	FD336	2						FD336			
TM													
80 GS, MC	80	90	92	FD089	1					FD075			
80 GS, MC	80	93	FD138	1						FD165			
JUNIOR 80	80	05	FD138	1						FD093			
JUNIOR 85	85	05	FD138	1						FD093			
MX 85	85	01	04	FD138	1					FD165			
MX 85	85	05	12	FD138	1	DF828	W	FLW		FD286			
MX 85	85	13	FD278	1	DF832	W				FD278	DF833	W	
JUNIOR 100	100	05	FD138	1						FD093			
125 CROSS	125	00	FD138	1	DF828	W	FLW			FD165			
125 ENDURO/MX	125	00	FD138	1	DF828	W	FLW			FD165			





APPLICATIONS

PADS FD

DISCS DF

SHOES MF

LINES FK

BRACKETS SP

KITS KG

CROSS REFERENCE

BRAND & MODEL · MARCA Y MODELO MARCA E MODELLO · MARQUE ET MODÈLE	C.C.	YEAR	FRONT					REAR					KITS KG	
			FD _{MAX}	N°	DF	OE	UPGRADE 1	UPGRADE 2	FD _{MAX}	DF	OE	UPGRADE		
continue TM														
125 GS, MC	125	90 92	FD089	1							FD075			
125 GS, MC	125	93	FD138	1							FD165			
EN 125	125	04 14	FD138	1	DF828	W	FLW				FD286	DF829	W	WLL
EN 125	125	15	FD138	1	DF828	W	FLW				FD286	DF840	W	WLL
MX 125	125	05 14	FD138	1	DF828	W	FLW				FD286	DF829	W	WLL
MX 125	125	15	FD138	1	DF828	W	FLW				FD286	DF840	W	WLL
SMM 125	125	14	FD262	1							FD012	DF829	W	WLL
SMR 125	125	14	FD262	1	DF828	FLW					FD286	DF829	W	WLL
EN144	144	14 14	FD138	1	DF828	W	FLW				FD286	DF829	W	WLL
EN144	144	15	FD138	1	DF828	W	FLW				FD286	DF840	W	WLL
MX 144	144	15	FD138	1	DF828	W	FLW				FD286	DF840	W	WLL
250 ENDURO 4T	250	00	FD138	1	DF828	W	FLW				FD165			
EN 250	250	04 14	FD138	1	DF828	W	FLW				FD286	DF829	W	WLL
EN 250	250	15	FD138	1	DF828	W	FLW				FD286	DF840	W	WLL
EN 250 F	250	04 14	FD138	1	DF828	W	FLW				FD286	DF829	W	WLL
EN 250 F	250	15	FD138	1	DF828	W	FLW				FD286	DF840	W	WLL
MX 250	250	05 14	FD138	1	DF828	W	FLW				FD286	DF829	W	WLL
MX 250	250	15	FD138	1	DF828	W	FLW				FD286	DF840	W	WLL
MX 250 F	250	05 14	FD138	1	DF828	W	FLW				FD286	DF829	W	WLL
MX 250 F	250	15	FD138	1	DF828	W	FLW				FD286	DF840	W	WLL
300 ENDURO 4T	300	01	FD138	1	DF828	W	FLW				FD165			
EN 300	300	14 14	FD138	1	DF828	W	FLW				FD286	DF829	W	WLL
EN 300	300	15	FD138	1	DF828	W	FLW				FD286	DF840	W	WLL
MX 300	300	14 14	FD138	1	DF828	W	FLW				FD286	DF829	W	WLL
MX 300	300	15	FD138	1	DF828	W	FLW				FD286	DF840	W	WLL
400 4T E/CROSS	400	00 02	FD138	1	DF828	W	FLW				FD165			
400 4T E/CROSS	400	03	FD138	1	DF828	W	FLW				FD093			
EN 450 F	450	04 14	FD138	1	DF828	W	FLW				FD286	DF829	W	WLL
EN 450 F	450	15	FD138	1	DF828	W	FLW				FD286	DF840	W	WLL
MX 450 F	450	05 14	FD138	1	DF828	W	FLW				FD286	DF829	W	WLL
MX 450 F	450	15	FD138	1	DF828	W	FLW				FD286	DF840	W	WLL
SMR 450 F	450	14 14	FD262	1							FD286	DF829	W	WLL
SMR 450 F	450	15	FD373	1							FD286	DF840	W	WLL
SMX 450 F	450	04 14	FD262	1	DF828	W	FLW				FD286	DF829	W	WLL
530 4T E/CROSS	530	03	FD138	1	DF828	W	FLW				FD093			
EN 530 F	530	04 14	FD138	1	DF828	W	FLW				FD286	DF829	W	WLL
EN 530 F	530	15	FD138	1	DF828	W	FLW				FD286	DF840	W	WLL
MX 530 F	530	05 14	FD138	1	DF828	W	FLW				FD286	DF829	W	WLL
MX 530 F	530	15	FD138	1	DF828	W	FLW				FD286	DF840	W	WLL
SMM 530 F	530	14	FD262	1							FD286	DF829	W	WLL
SMR 530 F	530	14 14	FD262	1							FD286	DF829	W	WLL
SMR 530 F	530	15	FD373	1							FD286	DF840	W	WLL
SMX 530 F	530	10 14	FD262	1							FD286	DF829	W	WLL
SMX 660 F	660	04 14	FD262	1	DF828	W	WLL	RW			FD286	DF829	W	WLL
SMX 660 F	660	15	FD262	1	DF828	W	FLW				FD286	DF840	W	WLL
TOMOS														
50 SE	50	04	FD133	1							FD065			
STEERMATE	50	04	FD065	1							MF	-		
YOUNGSTR RACING	50	04	FD065	1	DF037	W	RW	FLS			MF	-		
125 SE	125	04	FD133	1							FD065			
125 SM	125	05	FD220	1							FD065			
TORROT														
BUSINESS	EL	18	FD439	1							FD095			
CITY	EL	18	FD439	1							FD095			
MUVI	EL	18	FD439	1							FD095			
TRIAL TXE	EL	18	FD223	1							FD224			
TRIUMPH														
DAYTONA 600	600	03	FD099	2	DF877	CW	CRW				FD103	DF013	W	
SPEED FOUR	600	03	FD099	2	DF877	CW	CRW				FD103	DF013	W	
TT 600	600	00	FD099	2	DF877	CW	CRW				FD103	DF013	W	
DAYTONA 650	650	03 05	FD099	2	DF877	CW	CRW				FD103	DF013	W	
DAYTONA 675	675	09	FD414	2	DF876	CW	CRW				FD103	DF013	W	
DAYTONA 675 R	675	11 12	FD373	2	DF876	CW	CRW				FD103	DF013	W	
DAYTONA 675 R	675	13	FD373	2	DF906	CW	CRW				FD103	DF907	W	
DAYTONA 675 SE	675	09	FD414	2	DF876	CW	CRW				FD103	DF013	W	
DAYTONA TRIPLE	675	06 08	FD331	2	DF876	CW	CRW				FD103	DF013	W	
STREET TRIPLE	675	07	FD140	2	DF876	CW	CRW				FD103	DF013	W	
STREET TRIPLE R	675	09 12	FD331	2	DF876	CW	CRW				FD103	DF013	W	
STREET TRIPLE R	675	13	FD331	2	DF906	CW	CRW				FD165	DF907	W	
STREET TRIPLE RX	675	15	FD331	2	DF906	CW	CRW				FD165	DF907	W	
BONNEVILLE AMERICA	750	02	FD140	1	DF914	CW					FD140			
DAYTONA 750 SPORT	750	91	FD099	2	DF651	CW					FD117	DF875	W	



BRAND & MODEL · MARCA Y MODELO MARCA E MODELLO · MARQUE ET MODÈLE	C.C.	YEAR	FRONT						REAR				KITS KG
			FD _{MF}	N°	DF	OE	UPGRADE 1	UPGRADE 2	FD _{MF}	DF	OE	UPGRADE	
continue TRIUMPH													
TRIDENT 750 (left)	750	93	FD086	2	DF652	CW							
TRIDENT 750 (right)	750	93	FD117	2	DF652	CW			FD117	DF875	W		
DAYTONA LE	765	20	FD373	2	DF906	CW	CRW		FD165	DF907	W		
STREET TRIPLE R	765	17	FD475	2	DF906	CW	CRW		FD165	DF907	W		
STREET TRIPLE RS	765	17	FD373	2	DF906	CW	CRW		FD165	DF907	W		
STREET TRIPLE S	765	17	FD266	2	DF906	CW	CRW		FD165	DF907	W		
SPEEDMASTER	790	03	FD140	2	DF914	CW			FD140				
AMERICA	800	05	FD266	1	DF914	CW			FD086				
BONNEVILLE /T100	800	04	05	FD140	1	DF914	CW		FD086	DF915	W		
BONNEVILLE /T100	800	05	07	FD140	1	DF914	CW		FD086	DF915	W		
BONNEVILLE EFI /T100	800	08	FD140	1	DF914	CW			FD086	DF915	W		
TIGER 800	800	11	FD266	2	DF930	FLW			FD103	DF915	W		
TIGER 800 XC	800	11	14	FD266	2	DF930	FLW		FD103	DF915	W		
TIGER 800 XC ABS	800	11	14	FD266	2	DF930	FLW		FD103	DF915	W		
TIGER 800 XCx	800	15	FD266	2	DF930	FLW			FD103	DF915	W		
TIGER 800 XCx ABS	800	15	FD266	2	DF930	FLW			FD103	DF915	W		
TIGER 800 XRx	800	15	FD266	2	DF930	FLW			FD103	DF915	W		
TIGER 800 XRx ABS	800	15	FD266	2	DF930	FLW			FD103	DF915	W		
BONNEVILLE SE	850	09	FD140	1	DF918	FLW			FD086	DF915	W		
BONNEVILLE ACE	865	15	FD140	1	DF918	FLW			FD086	DF915	W		
BONNEVILLE NEW CHURCH	865	15	FD140	1	DF918	FLW			FD086	DF915	W		
BONNEVILLE SPIRIT	865	15	FD140	1	DF918	FLW			FD086	DF915	W		
SPEEDMASTER	865	10	FD140	1	DF918	FLW			FD086	DF915	W		
STEVE McQUEEN SE	865	12	FD140	1	DF918	FLW			FD086	DF915	W		
THRUXTON 865	865	04	07	FD140	1	DF874	CW		FD086	DF915	W		
THRUXTON 865 ACE	865	15	FD140	1	DF874	CW			FD086	DF915	W		
THRUXTON 865 EFI	865	08	FD140	1	DF874	CW			FD086	DF915	W		
ADVENTURER	900	99	FD140	2	DF022	W			FD140	DF915	W		
DAYTONA 900	900	93	96	FD099	2	DF651	CW		FD117	DF875	W		
DAYTONA 900 T-595	900	97	FD099	2	DF653	CW			FD086	DF013	W		
LEGEND TT	900	99	FD266	1	DF022	W			FD140				
SCRAMBLER	900	06	07	FD140	1	DF914	CW		FD086	DF915	W		
SCRAMBLER EFI	900	08	FD140	1	DF914	CW			FD086	DF915	W		
SPRINT 900 (left)	900	93	FD086	2	DF651	CW							
SPRINT 900 (right)	900	93	FD117	2	DF651	CW			FD117	DF875	W		
STREET CUP	900	17	FD266	1	DF906	CW			FD117	DF915	W		
STREET SCRAMBLER	900	17	18	FD266	1	DF906	CW		FD086	DF915	W		
STREET SCRAMBLER	900	19	FD437	1	DF906	CW			FD086	DF915	W		
STREET TWIN	900	16	18	FD266	1	DF906	CW		FD086	DF915	W		
STREET TWIN	900	19	FD437	1	DF906	CW			FD086	DF915	W		
T-100	900	17	FD266	1	DF918	FLW			FD086	DF915	W		
T-100 BLACK	900	17	FD266	1	DF918	FLW			FD086	DF915	W		
THUNDERBIRD 900/SPORT	900	95	FD266	2	DF914	CW			FD140	DF916	W		
TIGER 900	900	20	FD373	2	DF929	CW			FD165				
TIGER 900 (left)	900	93	98	FD086	2	DF005	W						
TIGER 900 (right)	900	93	98	FD117	2	DF005	W		FD117				
TIGER 900 GT / PRO	900	20	FD373	2	DF929	CW			FD165				
TIGER 900 RALLY / PRO	900	20	FD373	2	DF929	CW			FD165				
TRIDENT 900 (left)	900	93	FD086	2	DF652	CW							
TRIDENT 900 (right)	900	93	FD117	2	DF652	CW			FD117	DF875	W		
TRIDENT 900 SPRINT	900	95	FD099	2	DF652	CW			FD117	DF875	W		
TROPHY 900	900	94	FD099	2	DF651	CW			FD117	DF875	W		
TROPHY 900 (left)	900	92	93	FD086	2	DF652	CW						
TROPHY 900 (right)	900	92	93	FD117	2	DF652	CW		FD117	DF875	W		
DAYTONA 955i	955	99	00	FD099	2	DF653	CW		FD086	DF013	W		
DAYTONA 955i	955	01	01	FD099	2	DF653	CW		FD103	DF013	W		
DAYTONA 955i	955	02	FD099	2	DF655	CW			FD103	DF013	W		
SPEED TRIPLE 955 i	955	99	01	FD099	2	DF651	CW		FD086	DF013	W		
SPEED TRIPLE 955 i	955	02	FD099	2	DF655	CW			FD086	DF013	W		
SPRINT RS	955	00	FD099	2	DF653	CW			FD117	DF915	W		
SPRINT ST 955	955	99	FD099	2	DF653	CW			FD086	DF915	W		
TIGER 955	955	99	FD140	2					FD117				
SPEED TRIPLE T-509	995	99	FD099	2	DF653	CW			FD086	DF013	W		
SPEED TRIPLE 1050	1050	05	05	FD262	2	DF661	CW	CRW	FD086	DF013	W		
SPEED TRIPLE 1050	1050	06	07	FD331	2	DF661	CW	CRW	FD086	DF013	W		
SPEED TRIPLE 1050	1050	08	10	FD262	2				FD086	DF013	W		
SPEED TRIPLE 1050	1050	11	11	FD262	2				FD086	DF915	W		
SPEED TRIPLE R	1050	12	17	FD373	2	DF661	CW	CRW	FD086	DF013	W		
SPEED TRIPLE RS	1050	18	FD373	2	DF929	CW			FD086				
SPEED TRIPLE S	1050	16	17	FD373	2				FD086				
SPEED TRIPLE S	1050	18	FD373	2	DF929	CW			FD086				
SPRINT GT 1050	1050	10	FD099	2					FD086	DF915	W		





APPLICATIONS

PADS FD

DISCS DF

SHOES MF

LINES FK

BRACKETS SP

KITS KG

CROSS REFERENCE

BRAND & MODEL · MARCA Y MODELO MARCA E MODELLO · MARQUE ET MODÈLE	C.C.	YEAR	FRONT					REAR				KITS KG	
			FD _{MF}	N°	DF	OE	UPGRADE 1	UPGRADE 2	FD _{MF}	DF	OE		UPGRADE
continue TRIUMPH													
SPRINT ST 1050	1050	05	05	FD099	2					FD086	DF915	W	
SPRINT ST 1050	1050	06		FD331	2	DF655	CW			FD086	DF915	W	
TIGER 1050	1050	07		FD331	2	DF661	CW	CRW		FD117	DF915	W	
TIGER 1050 ABS	1050	07		FD331	2	DF661	CW	CRW		FD117	DF915	W	
TIGER SPORT 1050 ABS	1050	13		FD331	2	DF661	CW	CRW		FD117	DF915	W	
DAYTONA 1100 SPORT	1100	91		FD099	2	DF651	CW			FD117	DF875	W	
1200-3 (left)	1200	93		FD086	2	DF651	CW						
1200-3 (right)	1200	93		FD117	2	DF651	CW			FD117	DF875	W	
1200-4 (left)	1200	93		FD086	2	DF651	CW						
1200-4 (right)	1200	93		FD117	2	DF651	CW			FD117	DF875	W	
BOBBER TFC	1200	20		FD373	2					FD165	DF915	W	
BONNEVILLE BOBBER	1200	17	17	FD266	1	DF906	CW			FD103	DF915	W	
BONNEVILLE BOBBER	1200	18		FD138	2	DF906	CW			FD103	DF915	W	
BONNEVILLE BOBBER BLACK	1200	18		FD138	2	DF906	CW			FD103	DF915	W	
BONNEVILLE BOBBER SPORT	1200	20		FD138	2	DF906	CW			FD103	DF915	W	
BONNEVILLE SPEEDMASTER	1200	18		FD138	2	DF906	CW			FD103	DF915	W	
SCRAMBLER 1200 XC	1200	19		FD373	2	DF929	CW			FD138			
SCRAMBLER 1200 XE	1200	19		FD373	2	DF929	CW			FD138			
T-120	1200	16		FD266	2	DF906	CW			FD086	DF915	W	
T-120 BLACK	1200	16		FD266	2	DF906	CW			FD086	DF915	W	
THRUXTON	1200	16		FD266	2	DF906	CW			FD117	DF907	W	
THRUXTON R	1200	16		FD373	2	DF906	CW			FD117	DF907	W	
THRUXTON R BLACK	1200	20		FD373	2	DF906	CW			FD117	DF907	W	
THRUXTON RS	1200	20		FD373	2	DF906	CW			FD117	DF907	W	
TIGER 1200 XC	1200	18		FD475	2	DF930	FLW			FD187	DF931	W	
TIGER 1200 XCA	1200	18		FD475	2	DF930	FLW			FD187	DF931	W	
TIGER 1200 XCX	1200	18		FD475	2	DF930	FLW			FD187	DF931	W	
TIGER 1200 XR	1200	18		FD475	2	DF930	FLW			FD187	DF931	W	
TIGER 1200 XRT	1200	18		FD475	2	DF930	FLW			FD187	DF931	W	
TIGER 1200 XRX	1200	18		FD475	2	DF930	FLW			FD187	DF931	W	
TIGER EXPLORER	1200	12	15	FD099	2	DF930	FLW			FD187	DF931	W	
TIGER EXPLORER XC	1200	16	17	FD475	2	DF930	FLW			FD187	DF931	W	
TIGER EXPLORER XCA	1200	16	17	FD475	2	DF930	FLW			FD187	DF931	W	
TIGER EXPLORER XCX	1200	16	17	FD475	2	DF930	FLW			FD187	DF931	W	
TIGER EXPLORER XR	1200	16	17	FD475	2	DF930	FLW			FD187	DF931	W	
TIGER EXPLORER XRT	1200	16	17	FD475	2	DF930	FLW			FD187	DF931	W	
TIGER EXPLORER XRX	1200	16	17	FD475	2	DF930	FLW			FD187	DF931	W	
TROPHY 1200	1200	94		FD099	2	DF651	CW			FD117	DF875	W	
TROPHY 1200 (left)	1200	91	93	FD086	2	DF651	CW						
TROPHY 1200 (right)	1200	91	93	FD117	2	DF651	CW			FD117	DF875	W	
TROPHY 1200	1215	13		FD372	2					FD086			
THUNDERBIRD 1600	1600	09		FD099	2	DF918	FLW			FD172			
THUNDERBIRD COMMANDER	1700	14		FD099	2	DF918	FLW			FD172			
THUNDERBIRD STORM 1700	1700	11		FD099	2	DF918	FLW			FD172			
ROCKET III	2300	04		FD099	2	DF655	CW			FD172			
ROCKET III ROADSTER	2300	10		FD099	2	DF655	CW			FD172			
ROCKET 3 GT	2500	20		FD373	2	DF929	CW			FD475			
ROCKET 3 R	2500	20		FD373	2	DF929	CW			FD475			
ROCKET 3 TFC	2500	20		FD373	2	DF929	CW			FD475			
TRS													
ONE 280	300	16		FD223	1	DF808	W			FD224	DF809	W	
ONE 300	300	16		FD223	1	DF808	W			FD224	DF809	W	
TVS COLOMBIA													
ROCKZ 125	125	16		FD117	1					MF	-		
STRYKER 125	125	16		FD117	1					MF	-		
APACHE RTR 160	160	12		FD117	1					MF	-		
APACHE RTR 180	180	12		FD117	1					MF	-		
APACHE 200	200	17		FD117	1					FD			
UM COLOMBIA													
MAGNETIC 100	100			FD252	1					MF	-		
VENUS 115 R	115			FD073	1					MF	-		
DYNAMIC 125	125			FD073	1					MF	-		
MAGNETIC 125	125			FD252	1					MF	-		
MAX 125 R	125			FD252	1					MF	-		
NITROX 125 R	125			FD095	1					MF	-		
POWER MAX GP 125	125			FD086	1					MF	-		
FASTWIND 150 R	150			FD073	1					MF	-		
GP1 150 R	150			FD086	1					MF	-		
XPEED 150	150			FD086	1					MF	-		
REV 180 R	180			FD252	1					MF	-		
FASTWIND 180	180			FD073	1					FD073			
FASTWIND 200 R	200			FD073	1					FD117			



BRAND & MODEL · MARCA Y MODELO MARCA E MODELLO · MARQUE ET MODÈLE	C.C.	YEAR	FRONT					REAR				KITS KG
			FD _{MF}	N°	DF	OE	UPGRADE 1	UPGRADE 2	FD _{MF}	DF	OE	
continue UM COLOMBIA												
DSF 200	200		FD086	1					MF	-		
DSR 200	200		FD086	1					MF	-		
DTF 200	200		FD086	1					MF	-		
SMF 200	200		FD086	1					MF	-		
XTREET 200 NAKED SPORT	200		FD073	1					FD117			
FASTWIND 220	220		FD073	1					FD073			
V2S 250 R	250		FD073	2					FD073			
V2S 650 R	650		FD073	2								
URAL												
URAL CROSS	750	11	FD176	1					MF			
URAL RANGER	750	11	FD176	1					MF			
URAL RETRO	750	11	FD176	1					MF			
URAL SOLO	750	11	FD176	1					MF			
URAL SPORTSMAN	750	11	FD176	1					MF			
URAL TOURIST	750	11	FD176	1					MF			
URAL URAL T	750	11	FD176	1					MF			
URAL WOLF	750	11	FD176	1					MF			
UVM												
BINGO 50	50	99	FD136	1	DF466	W			MF	-		
BINGO 125	125	99	FD136	1	DF466	W			MF	-		
VECTRIX												
VECTRIX VT 1	EL	14	FD187	1					FD075			
VECTRIX VX 1	EL	07	FD138	1					FD138			
VECTRIX VX 2	EL	12	FD073	1					FD094			
VECTRIX VX 3	EL	12	FD220	1					FD138			
VENTO												
TRITON r4	100	06	FD095	1					MF	-		
WORKMAN	110	06	FD073	1					MF	-		
WORKMAN	125	06	FD095	1					MF	-		
PHANTERA 150	150	06	FD095	1					MF	-		
PHANTOM r4i	150	06	FD095	1					MF	-		
VERTEMATI												
492 ENDURO	500	99	00	FD138	1				FD165			
492 SUPERMOTARD	500	99	00	FD068	1				FD165			
495 CROSS	500	99	00	FD138	1				FD165			
C500	500	01	01	FD138	1				FD165			
E 510	500	02		FD138	1				FD165			
VERTIGO												
COMBAT CAMO	300	15		FD460	1	DF808	W		FD224	DF809	W	
COMBAT ICE HELL	300	15		FD460	1	DF808	W		FD224	DF809	W	
VICTORY												
OCTANE	1200	17		FD172	1				FD165			
CROSS ROADS	1500	10		FD331	2	DF472	FLW	FLV	FD140	DF472	FLW	FLV
CRUISER	1500	01		FD176	1	DF472	FLW	FLV	FD172	DF472	FLW	FLV
DE LUXE	1500	01		FD176	1	DF472	FLW	FLV	FD172	DF472	FLW	FLV
HAMMER / S	1500	01	07	FD176	2	DF472	FLW	FLV	FD172	DF472	FLW	FLV
JACKPOT	1500	10		FD331	2	DF472	FLW	FLV	FD140	DF472	FLW	FLV
KING PIN	1500	08		FD331	1	DF472	FLW	FLV	FD140	DF472	FLW	FLV
SPORTCRUISER	1500	01		FD176	1	DF472	FLW	FLV	FD172	DF472	FLW	FLV
TOURING CRUISER	1500	03		FD176	1	DF472	FLW	FLV	FD172	DF472	FLW	FLV
V92C	1500	01		FD176	1	DF472	FLW	FLV	FD172	DF472	FLW	FLV
VEGAS	1500	03	07	FD176	1	DF472	FLW	FLV	FD172	DF472	FLW	FLV
VEGAS 8 BALL	1500	05	07	FD176	1	DF472	FLW	FLV	FD172	DF472	FLW	FLV
CORY NESS CROOS COUNTRY	1731	11		FD331	2	DF472	FLW	FLV	FD140	DF472	FLW	FLV
CROSS COUNTRY	1731	10		FD331	2	DF472	FLW	FLV	FD140	DF472	FLW	FLV
CROSS COUNTRY 8 BALL	1731	15		FD331	2	DF472	FLW	FLV	FD140	DF472	FLW	FLV
CROSS COUNTRY TOUR	1731	12		FD331	2	DF472	FLW	FLV	FD140	DF472	FLW	FLV
GUNNER	1731	15		FD331	1	DF472	FLW	FLV	FD172	DF472	FLW	FLV
HAMMER / S	1731	08		FD331	2	DF472	FLW	FLV	FD140	DF472	FLW	FLV
HAMMER 8 BALL	1731	10		FD331	1	DF472	FLW	FLV	FD172	DF472	FLW	FLV
HIGH BALL	1731	15		FD331	2	DF472	FLW	FLV	FD172	DF472	FLW	FLV
JUDGE	1731	15		FD331	1	DF472	FLW	FLV	FD172	DF472	FLW	FLV
MAGNUM	1731	15		FD331	1	DF472	FLW	FLV	FD172	DF472	FLW	FLV
MAGNUM X1	1731	17		FD331	1	DF472	FLW	FLV	FD172	DF472	FLW	FLV
VEGAS	1731	08		FD331	1	DF472	FLW	FLV	FD140	DF472	FLW	FLV
VEGAS 8 BALL	1731	08		FD331	1	DF472	FLW	FLV	FD140	DF472	FLW	FLV
VISION	1731	16		FD331	1	DF472	FLW	FLV	FD140	DF472	FLW	FLV
VISION 8 BALL	1731	10		FD331	2	DF472	FLW	FLV	FD140	DF472	FLW	FLV
VILLA												
50 AX	50	93		FD136	1	DF466	W		MF	-		
50 GZ	50	93		FD153	1	DF466	W		MF	-		
VOLTA												

APPLICATIONS
 PADS FD
 DISCS DF
 SHOES MF
 LINES FK
 BRACKETS SP
 KITS KG
 CROSS REFERENCE



APPLICATIONS

PADS FD

DISCS DF

SHOES MF

LINES FK

BRACKETS SP

KITS KG

CROSS REFERENCE

BRAND & MODEL * MARCA Y MODELO MARCA E MODELLO * MARQUE ET MODÈLE	C.C.	YEAR	FRONT					REAR				KITS KG	
			FD _{MF}	N°	DF	OE	UPGRADE 1	UPGRADE 2	FD _{MF}	DF	OE		UPGRADE
continue VOLTA													
BCN	EL	18	FD162	1						FD220			
FOREST	EL	18	FD086	1						FD075			
SM	EL	18	FD086	1						FD075			
SPORT	EL	18	FD162	1						FD220			
VOR													
MX 350	350	01	FD138	1						FD165	DF887	W	
EN 400	400	00	FD138	1						FD165	DF887	W	
EN 450	450	01	FD138	1						FD165	DF887	W	
EN 503	503	00	FD138	1						FD165	DF887	W	
MX 503	503	00	FD138	1						FD165	DF887	W	
RC 503	503	01	FD176	1	DF886					FD165	DF887	W	
SM 503	503	00	FD068	1	DF886					FD165	DF887	W	
EN 530	530	01	FD138	1						FD165	DF887	W	
VOXAN													
BOXER	1000	00	FD176	2	DF660	CW	CRW			FD220			
CAFÉ RACER	1000	99	FD176	2	DF660	CW	CRW			FD220			
CHARADE RACING	1000	06	FD262	2						FD220			
ROADSTER	1000	99	FD176	2	DF660	CW	CRW			FD220			
SCRAMBLER	1000	00	FD176	2	DF660	CW	CRW			FD165			
GTV 1200	1200	08	FD262	2						FD220			
YAMAHA													
AEROX 50	50	97	FD171	1	DF037	W	RW	FLS		FD206	DF037	W	RW
AEROX 50 NAKED	50	13	FD171	1	DF037	W	RW	FLS		FD206	DF037	W	RW
AXIS 50 (I)	50	93	FD170	1	DF466	W				MF630	-		
AXIS COSMO	50	95	FD153	1	DF466	W				MF630	-		
AXIS PLUS	50	95	FD153	1	DF466	W				MF630	-		
BELUGA 50	50	90	MF453		-					MF	-		
BREEZE 50	50	95	FD153	1	DF466	W				MF453	-		
BW'S 50	50	91	MF453		-					MF453	-		
BW'S SPY 50	50	95	FD153	1	DF473	W	RW	WS		MF453	-		
BW'S 50 R	50	95	FD170	1	DF473	W	RW	WS		MF453	-		
BW'S BUMP	50	96	FD171	1	DF473	W	RW	WS		MF453	-		
BW'S NEXT GENERATION 50	50	96	FD153	1	DF473	W	RW	WS		MF453	-		
BW'S NAKED	50	06	FD153	1	DF473	W	RW	WS		MF453	-		KG473
BW'S WHEEL12"	50	06	FD153	1	DF473	W	RW	WS		MF453	-		KG473
CR 50 TARGET	50	91	FD136	1	DF466	W				MF458	-		
CR 50 Z	50	92	FD079	1	DF466	W				MF458	-		
CR 50 Z	50	94	FD136	1	DF466	W				MF458	-		
CT 50 SUPER SPORT	50	90	MF458		-					MF458	-		
DT 50 LCD	50	96	FD084	1	DF486	W				MF453	-		
DT 50 LCD	50	04	FD162	1						FD065			
DT 50 SUPERMOTARD	50	03	FD084	1						FD075			
DT 50 SUPERMOTARD	50	05	FD162	1	DF674	W	FLW			FD065	DF698	W	
DT 50 R	50	94	FD079	1	DF486	W				MF453	-		
DT 50 R	50	05	FD065	1	DF658	W				FD270	DF698	W	
JOG	50	92	FD136	1	DF466	W				MF630	-		
JOG R	50	94	FD136	1	DF466	W				MF630	-		
JOG R	50	02	FD171	1	DF629	W	RW	FLS		MF	-		
JOG RR LC	50	02	FD171	1	DF629	W	RW	FLS		MF	-		
NEO'S	50	97	FD171	1	DF629	W	RW	FLS		MF458	-		
NEO'S 50 4T	50	09	FD171	1	DF629	W	RW	FLS		MF458	-		
RZ 50	50	02	FD214	1						MF	-		
SLIDER	50	99	FD206	1	DF037	W	RW	FLS		MF453	-		
TARGET	50	94	FD136	1	DF466	W				MF458	-		
TT R 50	50	06	MF		-					MF630	-		
TZR 50 RR	50	97	FD117	1	DF470	W				FD079	DF487	W	
TZR 50 RR	50	03	FD162	1						FD065			
WHY YH 50	50	98	FD153	1	DF015	W				MF453	-		
ZEST 50	50	93	FD170	1	DF466	W				MF	-		
BW'S 65	65	95	FD170	1	DF473	W	RW	WS		MF453	-		
YZ 65	65	18	FD097	1	DF441	W				FD299	DF497	W	
BELUGA 80	80	90	MF453		-					MF	-		
DT 80 LC	80	93	FD079	1						MF	-		
TZR 80 RR	80	92	FD117	1	DF470	W				FD079	DF487	W	
YZ 80	80	93	FD097	1	DF489	W				FD299	DF497	W	
ZEST 80	80	94	FD171	1	DF466	W				MF	-		
YZ 85 / LW	85	03	FD097	1	DF489	W				FD299	DF497	W	KG489
CR 90 TARGET	90	91	FD136	1	DF466	W				MF458	-		
JOG 90	90	90	FD136	1	DF466	W				MF453	-		
TT R 90	90	00	MF		-					MF630	-		
AEROX 100	100	00	FD153	1	DF037	W	RW	FLS		FD206	DF037	W	RW
BW'S 100	100	00	FD153	1	DF473	W	RW	WS		MF640	-		



BRAND & MODEL · MARCA Y MODELO MARCA E MODELLO · MARQUE ET MODÈLE	C.C.	YEAR	FRONT					REAR				KITS KG	
			FD	N°	DF	OE	UPGRADE 1	UPGRADE 2	FD	DF	OE		UPGRADE
continue YAMAHA													
NEO'S 100	100	00	FD171	1	DF629	W	RW	FLS	MF640	-			
BELUGA 125 XC	125	93	MF475		-				MF640	-			
BW'S 125	125	10	FD473	1					MF478	-			
CYGNUS 125	125	95	MF640		-				MF458	-			
CYGNUS 125 / R	125	96	FD079	1					MF458	-			
CYGNUS 125 X	125	03	FD342	1					MF478	-			
CYGNUS 125 Xi	125	07	FD342	1					MF478	-			
D'ELIGHT	125	14	FD503	1					MF	-			
DT 125	125	99	FD079	1					FD079				
DT 125 R	125	05	FD079	1	DF457	W			FD114				
DT 125 X	125	05	FD172	1					FD114				
MAJESTY S	125	15	FD355	1					FD				
MAXTER 125	125	01	FD138	1					FD220				
MT 125	125	14	FD367	1					FD336				
N MAX 125 ABS	125	15	FD503	1	DF534	W			FD393	DF535	W		
SP 125 MAGESTY	125	98	FD138	1	DF492	W			MF640	-			
SP 125 MAGESTY	125	01	FD138	1	DF492	W			FD220	DF369	W		
SP 125 MAGESTY (TAIWAN)	125	99	FD140	1	DF502	W			MF	-			
SR 125	125	98	FD169	1	DF459	W			MF458	-			
TDR 125 R	125	91	FD068	1	DF660	CW	CRW		FD069	DF451	W		
TDR 125 R	125	93	FD169	1	DF660	CW	CRW		FD079	DF451	W		
TEO'S 125	125	00	FD153	1	DF492	W			MF640	-			
TRICITY DER/RIGHT	125	14	FD492	2					FD259				
TRICITY IZQ/LEFT	125	14	FD493	2					FD259				
TT R 125	125	00	FD097	1	DF486	W			MF630	-			
TW 125	125	98	FD214	1	DF467	W			MF	-			
TZ 125 GP	125	94	FD099	1					FD163				
TZR 125	125	90	FD057	1	DF660	CW	CRW		FD069	DF468	W		
TZR 125	125	92	FD099	1	DF660	CW	CRW		FD069	DF468	W		
TZR 125, MARLBORO RED ROCKET	125	93	FD068	1					FD012				
VINO 125	125	03	FD079	1					MF458	-			
VITY 125	125	08	FD393	1					MF	-			
WR 125	125	91	FD086	1	DF450	W			FD114	DF451	W		
WR 125 R	125	09	FD266	1					FD165				
WR 125 X	125	09	FD266	1					FD165				
X - CITY	125	09	FD140	1					FD220	DF524	W		
X - ENTER	125	12	FD473	1					MF	-			
X - MAX 125	125	06	FD355	1	DF500	W			FD220	DF524	W		
X - MAX 125	125	10	FD266	1	DF500	W			FD214	DF524	W	KG500	
X - MAX 125 ABS	125	10	FD266	1	DF500	W			FD214	DF524	W	KG500	
X - MAX 125	125	15	FD266	1	DF500	W			FD214	DF517	W	KG500	
X - MAX 125 ABS	125	15	FD266	1	DF500	W			FD214	DF516	W	KG500	
XT 125 R	125	05	FD270	1					FD270				
XT 125 X	125	05	FD162	1	DF674	W	FLW		FD270				
XV 125 VIRAGO	125	97	FD169	1	DF459	W			MF640	-			
XVS 125 DRAG STAR	125	00	FD169	1	DF459	W			MF640	-			
YBR 125	125	05	FD079	1					MF640	-			
YBR 125	125	07	FD393	1					MF640	-			
YBR 125 CUSTOM	125	08	FD393	1					MF640	-			
YZ 125	125	08	FD364	1	DF301	FLW	FLS	FRS	FD286	DF499	W	WLL	KG301
YZ 125	125	18	FD364	1	DF298	FLW	FLS	FRS	FD286	DF515	W	WLL	KG515
YZ 125, WR	125	90	FD086	1	DF457	W			FD114	DF451	W		
YZ 125, WR	125	92	FD086	1	DF462	W			FD114	DF451	W		
YZ 125, WR	125	98	FD164	1	DF462	W			FD093	DF479	W		
YZ 125, WR	125	01	FD164	1	DF301	FLW	FLS	FRS	FD093	DF479	W		
YZ 125, WR	125	03	FD164	1	DF301	FLW	FLS	FRS	FD286	DF499	W	WLL	
YZ 125, WR	125	04	FD164	1	DF301	FLW	FLS	FRS	FD286	DF499	W	WLL	
YZF 125 R	125	08	FD138	1	DF526	W			FD336	DF527	W		KG526
YZF 125 R	125	14	FD367	1					FD336				
CRYPTON-X T 135	135	08	FD393	1	DF512	CW	WS		MF	-			
FLY ONE	150	92	FD079	1					MF640	-			
MAXTER 150	150	01	FD138	1					FD220				
N MAX 150 ABS	150	15	FD503	1	DF534	W			FD393	DF535	W		
SP 150 MAGESTY	150	01	FD138	1	DF492	W			FD220	DF369	W		
TEO'S 150	150	01	FD153	1	DF492	W			MF640	-			
X - ENTER	150	12	FD473	1					MF	-			
TRICITY DER/RIGHT	155	17	FD492	2					FD259				
TRICITY IZQ/LEFT	155	17	FD493	2					FD259				
SP 180 MAGESTY	180	03	FD138	1	DF492	W			FD220	DF369	W		
TW 200	200	98	FD214	1	DF467	W			MF640	-			
WR 200 R	200	93	FD086	1	DF464	W			FD114	DF451	W		
TT 225 R	225	00	FD079	1					MF458	-			





APPLICATIONS

PADS FD

DISCS DF

SHOES MF

LINES FK

BRACKETS SP

KITS KG

CROSS REFERENCE

BRAND & MODEL · MARCA Y MODELO MARCA E MODELLO · MARQUE ET MODÈLE	C.C.	YEAR	FRONT					REAR				KITS KG	
			FD _{MF}	N°	DF	OE	UPGRADE 1	UPGRADE 2	FD _{MF}	DF	OE		UPGRADE
continue YAMAHA													
XT 225	225	92	00	FD079	1	DF467	W			MF	-		
XT 225	225	01		FD214	1	DF467	W			MF	-		
R1-Z	250	90		FD068	1	DF472	FLW	FLV		FD069			
SEROW 250	250	04		FD214	1	DF451	W			FD114			
SP 250 MAGESTY	250	96	97	FD169	1	DF458	W			MF	-		
SP 250 DX MAGESTY	250	98	99	FD169	1	DF458	W			FD214	DF490	W	
SP 250 DX MAGESTY	250	00		FD169	1	DF458	W			FD214	DF484	W	
SR 250, SP	250	91		FD056	1	DF480				MF451	-		
TT 250 R	250	93		FD086	1	DF464	W			FD114	DF451	W	
TY 250, Z, M	250	93		FD065	1					FD065			
TZ 250	250	90		FD099	2	DF472	FLW	FLV		FD163			
WR 250	250	91		FD086	1	DF450	W			FD114	DF451	W	
WR 250 F 4T	250	03	06	FD164	1	DF301	FLW	FLS	FRS	FD286	DF499	W	WLL
WR 250 F 4T	250	07		FD364	1	DF301	FLW	FLS	FRS	FD286	DF499	W	WLL
WR 250 R	250	08		FD164	1					FD286			
WR 250 X	250	08		FD266	1					FD286			
X - CITY	250	07		FD140	1					FD214	DF524	W	
X - MAX 250	250	05	09	FD355	1	DF500	W			FD214	DF524	W	
X - MAX 250	250	10	13	FD266	1	DF500	W			FD214	DF524	W	KG500
X - MAX 250	250	14		FD266	1	DF500	W			FD509	DF517	W	
X - MAX 250 ABS	250	14		FD266	1	DF500	W			FD214	DF516	W	
XG 250 TRICKER	250	04		FD214	1	DF467	W			FD114			
XT 250 X	250	06		FD214	1	DF467	W			FD114			
XTZ 250 X	250	07		FD086	1	DF450	W			FD114			
XV 250 VIRAGO	250	91	92	FD127	1	DF480				MF451	-		
XV 250 VIRAGO	250	93	95	FD056	1	DF480				MF451	-		
XV 250 VIRAGO	250	96	00	FD169	1	DF459	W			MF451	-		
XVS 250 DRAG STAR	250	01		FD169	1	DF459	W			MF640	-		
YBR 250	250	07		FD117	1					MF640	-		
YS 250 FAZER	250	06	10	FD117	1	DF470	W			MF640	-		
YS 250 FAZER	250	11		FD117	1	DF470	W			FD114			
YZ 250	250	08	17	FD364	1	DF301	FLW	FLS	FRS	FD286	DF499	W	WLL
YZ 250	250	18		FD364	1	DF298	FLW	FLS	FRS	FD286	DF515	W	WLL
YZ 250, W, RALLY	250	90	91	FD086	1	DF450	W			FD114	DF451	W	
YZ 250, WR	250	92	98	FD086	1	DF462	W			FD114	DF451	W	
YZ 250, WR	250	99	00	FD164	1	DF462	W			FD093	DF479	W	
YZ 250 F, WR F 4T	250	00	00	FD164	1	DF462	W			FD093	DF479	W	
YZ 250, WR	250	01	02	FD164	1	DF301	FLW	FLS	FRS	FD093	DF479	W	
YZ 250 F, WR F 4T	250	01	02	FD164	1	DF301	FLW	FLS	FRS	FD093	DF479	W	
YZ 250 F	250	03	06	FD164	1	DF301	FLW	FLS	FRS	FD286	DF499	W	WLL
YZ 250 F, WR F 4T	250	03	06	FD164	1	DF301	FLW	FLS	FRS	FD286	DF499	W	WLL
YZ 250 F	250	07	08	FD364	1	DF301	FLW	FLS	FRS	FD286	DF499	W	WLL
YZ 250 F	250	09	15	FD364	1	DF301	FLW	FLS	FRS	FD286	DF499	W	WLL
YZ 250 F	250	16	17	FD364	1	DF298	W	FLW	FRW	FD286	DF499	W	WLL
YZ 250 F	250	18		FD364	1	DF298	W	FLW	FRW	FD286	DF515	W	WLL
YZ 250 F 60th ANNIVERSARY	250	16		FD364	1	DF298	W	FLW	FRW	FD286	DF499	W	WLL
YZF - R25	250	15		FD485	1	DF460	CW			FD484	DF461	W	
TRICITY DER/RIGHT	300	20		FD492	2					FD259			
TRICITY IZQ/LEFT	300	20		FD493	2					FD259			
VERSITY	300	03		FD138	1					FD138			
X MAX 300	300	17		FD485	1	DF522	W			FD484	DF523	W	
MT 03	320	16		FD485	1	DF460	CW			FD484	DF461	W	
YZF - R3	320	15		FD485	1	DF460	CW			FD484	DF461	W	
RD 350 R	350	91		FD069	2	DF471	W			FD069	DF471	W	
YZ 360, RALLY	360	90		FD086	1	DF450	W			FD114	DF451	W	
FZ 400 FAZER	400	01		FD176	2	DF472	FLW	FLV		FD057	DF458	W	
FZR 400 RR	400	90		FD178	2	DF472	FLW	FLV		FD069	DF468	W	
SP 400 MAGESTY	400	04	04	FD142	1	DF500	W			FD352	DF501	W	
SP 400 MAGESTY	400	05		FD169	2	DF500	W			FD352	DF501	W	
SP 400 GRAND MAJESTY (JAP)	400	05		FD169	2	DF500	W			FD352	DF501	W	
SR 400	400	02	13	FD169	1	DF472	FLW	FLV		MF	-		
SR 400	400	14		FD142	1	DF474		CW		MF	-		
X - MAX 400	400	13		FD266	2	DF503	FLW			FD474	DF516	W	KG503
XJR 400 R	400	93	96	FD169	2	DF472	FLW	FLV		FD057	DF458	W	
XJR 400 R	400	97	00	FD176	2	DF472	FLW	FLV		FD057	DF458	W	
XJR 400 R	400	01		FD178	2	DF472	FLW	FLV		FD218	DF458	W	
WR 400 F	400	98	98	FD164	1	DF462	W			FD093	DF451	W	
WR 400 F	400	99	99	FD164	1	DF462	W			FD093	DF479	W	
YZ 400 F	400	98	98	FD164	1	DF462	W			FD093	DF451	W	
YZ 400 F	400	99	99	FD164	1	DF462	W			FD093	DF479	W	
WR 426 F	425	00	01	FD164	1	DF301	FLW	FLS	FRS	FD093	DF479	W	
WR 426 F	425	02	02	FD164	1	DF301	FLW	FLS	FRS	FD093	DF499	W	WLL



BRAND & MODEL · MARCA Y MODELO MARCA E MODELLO · MARQUE ET MODÈLE	C.C.	YEAR	FRONT					REAR				KITS	
			FD _{MF}	N°	DF	OE	UPGRADE 1	UPGRADE 2	FD _{MF}	DF	OE		UPGRADE
continue YAMAHA													
YZ 426 F	425	00	01	FD164	1	DF301	FLW	FLS	FRS	FD093	DF479	W	
YZ 426 F	425	02	02	FD164	1	DF301	FLW	FLS	FRS	FD093	DF499	W	WLL
WR 450 F	450	03	11	FD164	1	DF301	FLW	FLS	FRS	FD286	DF499	W	WLL
WR 450 F	450	12	15	FD164	1	DF301	FLW	FLS	FRS	FD286	DF499	W	WLL
WR 450 F	450	16		FD364	1	DF298	W	FLW	FRW	FD286	DF499	W	WLL
YZ 450 F	450	03	07	FD164	1	DF301	FLW	FLS	FRS	FD286	DF499	W	WLL
YZ 450 F	450	08	11	FD364	1	DF301	FLW	FLS	FRS	FD286	DF499	W	WLL
YZ 450 F	450	12	15	FD364	1	DF301	FLW	FLS	FRS	FD286	DF499	W	WLL
YZ 450 F	450	16	17	FD364	1	DF298	W	FLW	FRW	FD286	DF499	W	WLL
YZ 450 F	450	18	19	FD364	1	DF298	W	FLW	FRW	FD286	DF515	W	WLL
YZ 450 F	450	20		FD545	1	DF298	W	FLW	FRW	FD286	DF531	W	WLL
YZ 450 F 60th ANNIVERSARY	450	16		FD364	1	DF298	W	FLW	FRW	FD286	DF499	W	WLL
YZ 490 RALLY	490	90		FD080	1					MF456	-		
WR 500	500	92		FD086	1	DF457	W			FD114	DF451	W	
XP 500 T-MAX	500	00	03	FD142	1	DF493	W			FD260	DF494	W	
XP 500 T-MAX	500	04	07	FD169	2	DF503	FLW	CW		FD352	DF494	W	KG503
XP 500 T-MAX ABS	500	04	07	FD169	2	DF503	FLW	CW		FD352	DF494	W	KG503
XP 500 T-MAX	500	08		FD178	2	DF525	FLW			FD352	DF494	W	
XP 500 T-MAX ABS	500	08		FD178	2	DF525	FLW			FD352	DF494	W	
XP 500 T-MAX BLACK MAX	500	06	07	FD169	2	DF503	FLW	CW		FD352	DF494	W	KG503
XP 500 T-MAX CUP	500	03		FD068	1	DF498	CW	CRW		FD260	DF494	W	
XP 530 T-MAX	530	12	13	FD178	2	DF503	FLW	CW		FD260	DF528	W	KG503
XP 530 T-MAX ABS	530	12	14	FD178	2	DF503	FLW	CW		FD260	DF528	W	KG503
XP 530 T-MAX ABS	530	15		FD178	2	DF503	FLW	CW		FD260	DF528	W	KG503
XP 530 T-MAX DX ABS	530	17		FD178	2	DF503	FLW	CW		FD260	DF528	W	KG503
XP 530 T-MAX SX ABS	530	17		FD178	2	DF503	FLW	CW		FD260	DF528	W	KG503
XV 535 S VIRAGO	535	95		FD142	1	DF488	W			MF459	-		
XP 560 T-MAX	560	20		FD178	2	DF503	FLW	CW		FD260	DF528		KG503
XP 560 T-MAX TECH MAX	560	20		FD178	2	DF503	FLW	CW		FD260	DF528		KG503
FZS 600 FAZER	600	98	99	FD178	2	DF472	FLW	FLV		FD069	DF458	W	
FZS 600 S FAZER	600	00	03	FD178	2	DF472	FLW	FLV		FD069	DF458	W	
FZ 6 FAZER	600	04	06	FD169	2	DF495	CW	CRW		FD134	DF485	W	
FZ 6 S FAZER	600	04	06	FD169	2	DF495	CW	CRW		FD134	DF485	W	
FZ 6 /S FAZER ABS	600	06	06	FD169	2	DF495	CW	CRW		FD134	DF485	W	
FZ 6 S2	600	07		FD178	2	DF495	CW	CRW		FD134	DF485	W	
FZ 6 FAZER S2	600	07		FD178	2	DF495	CW	CRW		FD134	DF485	W	
FZ 6 S2 ABS	600	07		FD178	2	DF495	CW	CRW		FD134	DF485	W	
FZ 6 FAZER S2 ABS	600	07		FD178	2	DF495	CW	CRW		FD134	DF485	W	
FZR 600	600	90	95	FD087	2	DF472	FLW	FLV		FD057	DF458	W	
FZR 600 GENESIS	600	91	95	FD121	2	DF472	FLW	FLV		FD057	DF458	W	
SRX Classic by BIRD	600	90		FD069	2	DF471	W			FD069	DF458	W	
TT 600	600	90	92	FD080	1	DF457	W			MF451	-		
TT 600	600	93	94	FD086	1	DF452	W			FD114	DF451	W	
TT 600	600	95	97	FD138	1	DF452	W			FD165	DF451	W	
TT 600 S	600	94		FD079	1	DF452	W			FD079	DF451	W	
TT 600 R	600	99	02	FD138	1	DF452	W			FD165	DF451	W	
TT 600 RE	600	03		FD138	1	DF452	W			FD165	DF451	W	
XJ 6 S DIVERSION (FZ 6 R USA)	600	09		FD169	2	DF495	CW	CRW		FD134	DF511	W	
XJ 6 S DIVERSION ABS	600	09		FD169	2	DF495	CW	CRW		FD134	DF511	W	
XJ 6 S DIVERSION F	600	10		FD169	2	DF495	CW	CRW		FD134	DF511	W	
XJ 6 S DIVERSION NAKED	600	09		FD169	2	DF495	CW	CRW		FD134	DF511	W	
XJ 600 N / S	600	95	97	FD142	1	DF463	W			FD069	DF458	W	
XJ 600 N / S	600	96	03	FD169	2	DF474	CW			FD069	DF458	W	
XJ 600 S DIVERSION	600	91	97	FD142	1	DF463	W			FD069	DF458	W	
XJ 600 S DIVERSION	600	98	08	FD169	2	DF488	W			FD069	DF458	W	
XJ 600 SECA II	600	92	93	FD142	1	DF463	W			FD069	DF458	W	
XT 600 E	600	90	94	FD129	1	DF453	W			FD079	DF467	W	
XT 600 E	600	95		FD129	1	DF470	W			FD079	DF467	W	
YZF 600 THUNDER CAT	600	96	00	FD178	2	DF474	CW			FD057	DF458	W	
YZF 600 R-6	600	99	02	FD178	2	DF474	CW			FD214	DF491	W	
YZF 600 R-6	600	03	04	FD178	2	DF495	CW	CRW		FD134	DF496	W	
YZF 600 R-6	600	05	05	FD178	2	DF482	CW	CRW		FD134	DF496	W	
YZF 600 R-6	600	06	07	FD178	2	DF482	CW	CRW		FD134	DF496	W	
YZF 600 R-6	600	08	16	FD178	2	DF482	CW	CRW		FD134	DF496	W	
YZF 600 R-6	600	17		FD178	2	DF475	CW	CRW		FD363	DF496	W	
YZF 600 R-46	600	05		FD178	2	DF482	CW	CRW		FD134	DF496	W	
XVS 650 DRAG STAR	650	97		FD142	1	DF488	W			MF459	-		
XVS 650 STAR CLASSIC	650	97		FD142	1	DF488	W			MF459	-		
XVS 650 STAR SILVERADO	650	97		FD142	1	DF488	W			MF459	-		
MT-03	660	06		FD169	2	DF495	CW	CRW		FD165	DF485	W	
SZR 660	660	95		FD068	1	DF660	CW	CRW		FD165	DF468	W	
XT 660 R	660	04		FD172	1	DF448	CW			FD165	DF458	W	

APPLICATIONS
 PADS FD
 DISCS DF
 SHOES MF
 LINES FK
 BRACKETS SP
 KITS KG
 CROSS REFERENCE



APPLICATIONS

PADS FD

DISCS DF

SHOES MF

LINES FK

BRACKETS SP

KITS KG

CROSS REFERENCE

BRAND & MODEL · MARCA Y MODELO MARCA E MODELLO · MARQUE ET MODÈLE	C.C.	YEAR	FRONT					REAR				KITS KG
			FD _{MF}	N°	DF	OE	UPGRADE 1	UPGRADE 2	FD _{MF}	DF	OE	
continue YAMAHA												
XT 660 X	660	04	FD176	1				FD165	DF458	W		
XTZ 660 TENERE	660	93 98	FD129	1	DF470	W		FD079	DF467	W		
XT 660 Z TENERE	660	08	FD138	2	DF448	CW		FD165	DF458	W		
MT 07	700	14	FD178	2	DF455	FLW		FD134	DF469	W		
MT 07 ABS	700	14	FD178	2	DF455	FLW		FD134	DF469	W		
MT 07 MOTOCAGE	700	15	FD178	2	DF455	FLW		FD134	DF469	W		
MT 07 MOTOCAGE ABS	700	15	FD178	2	DF455	FLW		FD134	DF469	W		
MT 07 TRACER	700	16	FD178	2	DF455	FLW		FD134	DF469	W		
MT 07 TRACER GT	700	19	FD178	2	DF455	FLW		FD134	DF469	W		
XSR 700	700	15	FD178	2	DF455	FLW		FD134	DF469	W		
XTZ 700 TENERE	700	19	FD138	2				FD165				
XV 750	750	94 94	FD127	2	DF471	W		MF477	-			
XV 750	750	95	FD142	2	DF471	W		MF477	-			
XV 750 VIRAGO	750	93	FD087	2	DF471	W		MF477	-			
YZF 750 R, SP	750	93 95	FD157	2	DF660	CW CRW		FD057	DF458	W		
YZF-R7/OW02 RACE	750	99	FD193	2	DF498	CW CRW		FD163	DF458	W		
YZF-R7/OW02	750	99	FD178	2				FD218	DF458	W		
FAZER 8	800	10	FD178	2	DF482	CW CRW		FD134	DF500	W		
FZ 8	800	10	FD178	2	DF482	CW CRW		FD134	DF500	W		
MT 09	850	13	FD178	2	DF495	CW CRW		FD134	DF469	W		
MT 09 ABS	850	13	FD178	2	DF495	CW CRW		FD134	DF469	W		
MT 09 SP	850	18	FD178	2	DF495	CW CRW		FD134	DF469	W		
MT 09 SPORTS TRACKER ABS	850	14	FD178	2	DF495	CW CRW		FD134	DF469	W		
MT 09 STREET RALLY	850	14	FD178	2	DF495	CW CRW		FD134	DF469	W		
MT 09 TRACER ABS	850	15	FD178	2	DF495	CW CRW		FD134	DF469	W		
MT 09 TRACER ABS GT	850	18	FD178	2	DF495	CW CRW		FD134	DF469	W		
NIKEN	850	18	FD178	2	DF495	CW CRW		FD134				
NIKEN GT	850	19	FD178	2	DF495	CW CRW		FD134				
TDM 850	850	90 01	FD087	2	DF472	FLW FLV		FD057	DF458	W		
TRX 850	850	95	FD176	2	DF472	FLW FLV		FD057	DF458	W		
TDM 900	900	02 04	FD178	2	DF474	CW		FD295	DF458	W		
TDM 900 A	900	05	FD178	2	DF474	CW		FD295	DF458	W		
XJ 900 S DIVERSION	900	95	FD142	2	DF463	W		FD057	DF471	W		
XSR 900	900	16	FD178	2	DF495	CW CRW		FD134	DF469	W		
SCR 950	950	17	FD142	1	DF474	CW		FD295	DF513	W		
XVS 950 A MIDNIGHT STAR	950	09	FD142	1	DF498	CW		FD295	DF513	W		
XVS 950	950	13	FD142	1	DF440	CW		FD295	DF513	W		
XVS 950 R	950	13	FD142	1	DF440	CW		FD295	DF513	W		
XVS 950 BOLT (USA)	950	13	FD142	1	DF440	CW		FD295	DF513	W		
FZ 1 (USA)	1000	98 05	FD178	2	DF474	CW		FD329	DF471	W		
FZ 1 / FAZER	1000	06	FD178	2	DF475	CW CRW		FD134	DF485	W		
FZR 1000 EXUP	1000	93 95	FD143	2	DF660	CW CRW		FD057	DF471	W		
FZS 1000 FAZER	1000	98 05	FD178	2	DF474	CW		FD329	DF471	W		
MT 10	1000	16	FD178	2	DF475	CW CRW		FD134	DF496			
MT 10 SP	1000	17	FD178	2	DF475	CW CRW		FD363	DF496			
MT 10 TOURER EDITION	1000	18	FD178	2	DF475	CW CRW		FD363	DF496			
GTS 1000 OMEGA	1000	93	FD154	2				FD057	DF459	W		
XS-VI SAKURA	1000	09	FD169	2				FD057				
YZF 1.000 THUNDER ACE	1000	96 98	FD178	2	DF474	CW		FD057	DF458	W		
YZF 1.000 R-1	1000	98 01	FD178	2	DF474	CW		FD218	DF458	W		
YZF 1.000 R-1	1000	02 03	FD178	2	DF474	CW		FD214	DF491	W		KG474
YZF 1.000 R-1	1000	04 05	FD178	2	DF475	CW CRW		FD134	DF496	W		
YZF 1.000 R-1	1000	06 06	FD178	2	DF475	CW CRW		FD134	DF496	W		
YZF 1.000 R-1 SP	1000	06 06	FD178	2				FD134				
YZF 1.000 R-1	1000	07 08	FD365	2	DF520	CW CRW		FD134	DF496	W		
YZF 1.000 R-1	1000	09 11	FD365	2	DF520	CW CRW		FD134	DF496	W		
YZF 1.000 R-1 TCS	1000	12 14	FD365	2	DF520	CW CRW		FD134	DF496	W		
YZF - R1	1000	15	FD178	2	DF475	CW CRW		FD363	DF496	W		
YZF - R1M	1000	15	FD178	2	DF475	CW CRW		FD363	DF496	W		
BT 1100 BULL DOG	1100	01	FD178	2	DF474	CW		FD057	DF471	W		
XV 1100 VIRAGO	1100	93 94	FD087	2	DF471	W		MF459	-			
XV 1100 VIRAGO	1100	95 98	FD142	2	DF459	W		MF459	-			
XVS 1100 DRAG STAR	1100	99	FD169	2	DF488	W		FD057	DF459	W		
V MAX 1200 VMX	1200	93 94	FD121	2	DF459	W		FD057	DF459	W		
V MAX 1200 VMX	1200	95 02	FD121	2	DF474	W		FD057	DF459	W		
V MAX 1200 XMS	1200	03	FD121	2	DF474	W		FD057	DF459	W		
XJR 1200	1200	94 94	FD121	2	DF660	CW CRW		FD057	DF471	W		
XJR 1200 (EUROPA)	1200	95	FD068	2	DF660	CW CRW		FD057	DF471	W		
XTZ 1200 SUPER TENERE	1200	10	FD178	2	DF520	CW CRW		FD295	DF459	W		
XTZ 1200 SUPER TENERE ABS	1200	10	FD178	2	DF520	CW CRW		FD295	DF459	W		
XTZ 1200 SUPER TENERE ABS RAID EDITION	1200	18	FD178	2	DF520	CW CRW		FD295	DF459	W		
XTZ 1200 ZE SUPER TENERE ABS	1200	14	FD178	2	DF520	CW CRW		FD295	DF459	W		



BRAND & MODEL · MARCA Y MODELO MARCA E MODELLO · MARQUE ET MODÈLE	C.C.	YEAR	FRONT						REAR				KITS KG
			FD _{MF}	N°	DF	OE	UPGRADE 1	UPGRADE 2	FD _{MF}	DF	OE	UPGRADE	
continue YAMAHA													
FJR 1300	1300	01	02	FD178	2	DF474	CW			FD295	DF459	W	
FJR 1300	1300	03	05	FD178	2	DF498	CW	CRW		FD295	DF459	W	
FJR 1300 ABS	1300	06	07	FD372	2	DF498	CW	CRW		FD295	DF459	W	
FJR 1300 ABS	1300	08		FD372	2	DF498	CW	CRW		FD295	DF459	W	
VENTURE ROYALE 1300	1300	90		FD087	2	DF459	W			FD057			
XJR 1300	1300	99	00	FD178	2	DF474	CW			FD057	DF471	W	
XJR 1300	1300	01		FD178	2	DF474	CW			FD329	DF471	W	
XJR 1300 RACER	1300	15		FD178	2	DF474	CW			FD329	DF471	W	
XVS MIDNIGHT STAR 1300	1300	07		FD169	2	DF474	CW			FD295			
XZV 1.300 ROYAL STAR	1300	96	98	FD087	2	DF488	W			FD087	DF463	W	
XZV 1.300 TF ROYAL STAR VENTURE	1300	99		FD142	2	DF488	W			FD087	DF463	W	
XV 1600 WILD STAR	1600	99		FD142	2	DF488	W			FD087			
MT 01	1650	05	06	FD178	2	DF498	CW	CRW		FD140	DF471	W	
MT 01	1650	07		FD365	2	DF519	CW			FD140	DF471	W	
V MAX 1700	1700	09		FD365	2	DF475	CW	CRW		FD295			
XV 1700 ROAD STAR WARRIOR	1700	02	07	FD178	2	DF488	W			FD295			
XV 1700 ROAD STAR WARRIOR	1700	08		FD178	2	DF488	W			FD295			
XV STAR RAIDER	1900	08		FD178	2	DF495	CW	CRW		FD295			
XV 1900 STRATOLINER	1900	06		FD178	2	DF474	CW			FD295			
XVS 1900 MIDNIGHT STAR	1900	06	12	FD178	2	DF474	CW			FD295			
XVS 1900 MIDNIGHT STAR	1900	13		FD372	2	DF474	CW			FD295			
YAMAHA 4 Wheels													
YFM 80 D SHIFT	80	92		MF458		-				MF451	-		
YFM 80 E	80	93		MF458		-							
YFA 1B 125 BREEZE	125	91		MF458		-				MF451	-		
YFA 1B 125 BREEZE (KIT YAMAHA FR.)	125	91		MF458		-				FD220	DF729	W	
YFA 1D/E	125	92	93	MF458		-							
YFS 200 R BLASTER	200	03		FD095	2	DF477	W			FD076	DF476	W	
YFB 250 D/E TIMB	250	92	93	MF458		-				MF471	-		
YFM 250	250	01		FD095	2	DF477	W			MF	-		
YFM 250 R RAPTOR IZQ./LEFT	250	08		FD378	2								
YFM 250 R RAPTOR DER./RIGHT	250	08		FD379	2					FD076			
YFM 250 X BEAR TRACKER	250	01		FD095	2					MF	-		
YFM 250 BRUIN	250	05	06	FD095	2					MF	-		
YFM BIG BEAR	250	07		FD095	2					MF	-		
YFM 350 BRUIN87	350	04		FD095	2					MF	-		
YFM 350 FGW GRIZZLY	350	07		FD076	2					MF	-		
YFM 350 FWB BIG BEAR	350	99		FD095	2					MF	-		
YFM 350 R RAPTOR	350	04		FD076	2					FD076			
YFM 350 WOLVERINE	350	95		FD095	2					FD076	DF476	W	
YFZ 350 A,B,D,E BANSHEE	350	90	06	FD095	2	DF477	W			FD095	DF476	W	
YFM 400 FGW GRIZZLY	400	07		FD076	2	DF477	W			FD315			
YFM 400 FW BIG BEAR	400	00		FD095	2					MF	-		
YFM 400 FWA KODIAK	400	00		FD095	2					FD318			
YFM 400 FWE KODIAK	400	93	99	MF482		-				MF	-		
YFM 400 TODOS MODELOS	400	00		FD095	2					MF	-		
YFM 450	450	03		FD086	2					FD076			
YFM 450 FW GRIZZLY	450	07		FD076	2					FD315			
YFM 450 GRIZZLY IRS	450	10		FD095	2					FD			
YFM 450 GRIZZLY EPS	450	11		FD095	2					FD			
YFM 450 KODIAK	450	03		FD095	2					FD315			
YFM 450 WOLVERINE IZQ.	450	06		FD086	2								
YFM 450 WOLVERINE DER.	450	06		FD117	2					FD315			
YFZ 450 R IZQ./LEFT	450	09		FD117	2								
YFZ 450 R DER./RIGHT	450	09		FD086	2					FD284			
YFZ 450 S DER.	450	03	05	FD117	2	DF477	W						
YFZ 450 S IZQ.	450	03	05	FD086	2	DF477	W			FD076	DF730	W	
YFZ 450 S DER.	450	06		FD117	2	DF477	W						
YFZ 450 S IZQ.	450	06		FD086	2	DF477	W			FD063	DF732	W	
YFZ 450 R/V DER.	450	06		FD117	2	DF477	W						
YFZ 450 R/V IZQ.	450	06		FD086	2	DF477	W			FD284			
YFM 550 GRIZZLY IZQ./LEFT	550	09		FD378	2					FD380			
YFM 550 GRIZZLY DER./RIGHT	550	09		FD379	2					FD381			
YFM 600 GRIZZLY/HUNTING	600	98	01	FD076	2					MF	-		
YFM 600 FWA HUNTER	600	01		FD076	2					MF	-		
YFM 660 GRIZZLY	660	02		FD076	2					FD			
YFM 660 R RAPTOR	660	01		FD076	2	DF477	W			FD076	DF476	W	
YXR 660 RHINO 4X4 IZQ./LEFT	660	04		FD117	2	DF841	W						
YXR 660 RHINO 4X4 DER./RIGHT	660	04		FD086	2	DF841	W			FD318	DF842	W	
YFM 700 GRIZZLY IZQ./LEFT	700	07		FD378	2					FD380			
YFM 700 GRIZZLY DER./RIGHT	700	07		FD379	2					FD381			
YFM 700 R RAPTOR IZQ./LEFT	700	06	12	FD086	2	DF477	W						





APPLICATIONS

PADS **FD**

DISCS **DF**

SHOES **MF**

LINES **FK**

BRACKETS **SP**

KITS **KG**

CROSS REFERENCE

BRAND & MODEL • MARCA Y MODELO MARCA E MODELLO • MARQUE ET MODÈLE	C.C.	YEAR	FRONT						REAR				KITS KG
			FD	N°	DF	OE	UPGRADE 1	UPGRADE 2	FD	DF	OE	UPGRADE	
continue YAMAHA 4 Wheels													
YFM 700 R RAPTOR DER./RIGHT	700	06	12	FD117	2	DF477	W			FD318	DF732	W	
YFM 700 R RAPTOR IZQ./LEFT	700	13		FD086	2	DF477	W						
YFM 700 R RAPTOR DER./RIGHT	700	13		FD117	2	DF477	W			FD284	DF732	W	
YXR 700 RHINO 4X4 IZQ./LEFT	700	08		FD117	2	DF841	W						
YXR 700 RHINO 4X4 DER./RIGHT	700	08		FD086	2	DF841	W						
YAMAHA SIDExSIDE													
YZX 1000 R	1000	19		FD517	2	DF986	W			FD518	DF987	W	
YZX 1000 R SE	1000	16	18	FD517	2	DF973	W	V		FD518	DF973	W	V
YZX 1000 R SE	1000	19		FD517	2	DF986	W			FD518	DF987	W	
YZX 1000 R SS	1000	16	18	FD517	2	DF973	W	V		FD518	DF973	W	V
YZX 1000 R SS	1000	19		FD517	2	DF986	W			FD518	DF987	W	
YZX 1000 R SS SE	1000	16		FD517	2	DF973	W	V		FD518	DF973	W	V
YAMAHA SNOW													
V-MAX		92	96							FD184			
ZANELLA													
ARGENTO	50	94		FD170	1					MF	-		
PATAGONIA	50	94		FD089	1					MF	-		
RM3	50	94		FD084	1					MF	-		
SUDAMERICA	50	94		FD170	1					MF	-		
ZERO													
ZERO DS	EL	10	14	FD188	1					FD094			
ZERO DS	EL	15		FD172	1					FD165			
ZERO DS DUAL SPORT	EL	13		FD164	1					FD286			
ZERO FX	EL	20		FD176	1					FD165			
ZERO FX STEALTHFIGHTER	EL	13	13	FD164	1					FD286			
ZERO FX STEALTHFIGHTER	EL	14		FD164	1					FD103			
ZERO MX	EL	10	12	FD188	1					FD094			
ZERO MX	EL	13		FD164	1					FD286			
ZERO S	EL	10	12	FD188	1					FD094			
ZERO S	EL	13	13	FD164	1					FD286			
ZERO S	EL	14	14	FD164	1					FD286			
ZERO S	EL	15		FD172	1					FD165			
ZERO S STREETFIGHTER	EL	13	13	FD164	1					FD286			
ZERO S STREETFIGHTER	EL	14	14	FD164	1					FD103			
ZERO S STREETFIGHTER	EL	15		FD172	1					FD165			
ZERO SR	EL	20		FD176	1					FD165			
ZERO X	EL	10		FD188	1					FD094			
ZERO XU	EL	10	12	FD188	1					FD094			
ZERO XU URBAN CROSSER	EL	13		FD164	1					FD286			
ZONTES													
S - 250	250	18		FD266	1					FD103			
R - 310	310	18		FD266	1					FD103			
X - 310	310	18		FD266	1					FD103			

BRAKE PADS
PASTILLAS DE FRENO

PASTIGLIA FRENO
PLAQUETTES DE FREIN





APPLICATIONS

GALFER
FD
012
G1054
G1050
G1805
G1371

PADS **FD**

↔ 39,8
mm x
↕ 56,3
↔ 7,0

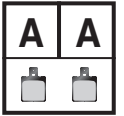
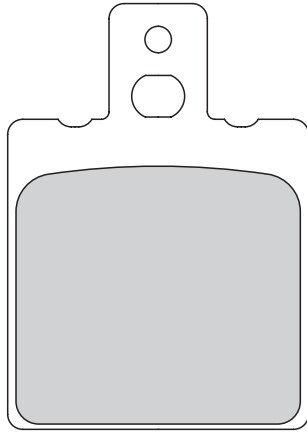

DISCS **DF**

GALFER
FD
013
G1054
G1805
G1370

SHOES **MF**

↔ 55,8
mm x
↕ 54,0
↔ 9,0

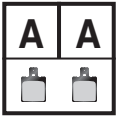
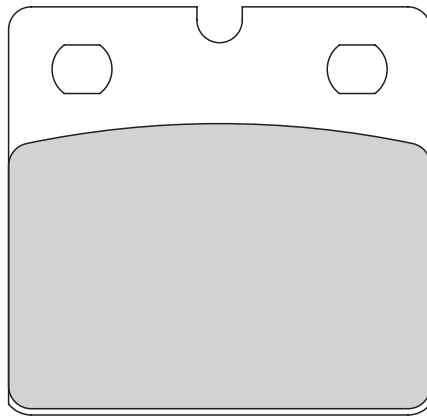

LINES **FK**

GALFER
FD
016
G1054

BRACKETS **SP**

↔ 67,1
mm x
↕ 48,9
↔ 9,5

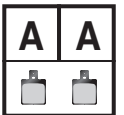
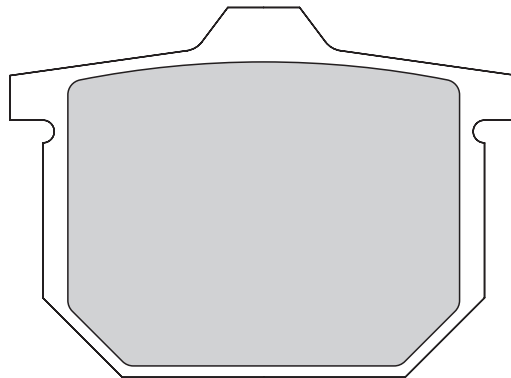

KITS **KG**

GALFER
FD
017
G1054

CROSS REFERENCE

↔ 67,4
mm x
↕ 50,0
↔ 11,0

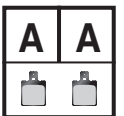
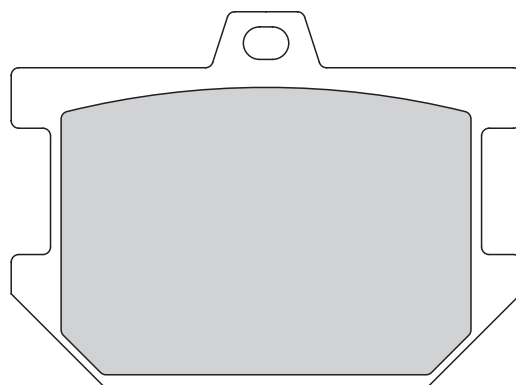

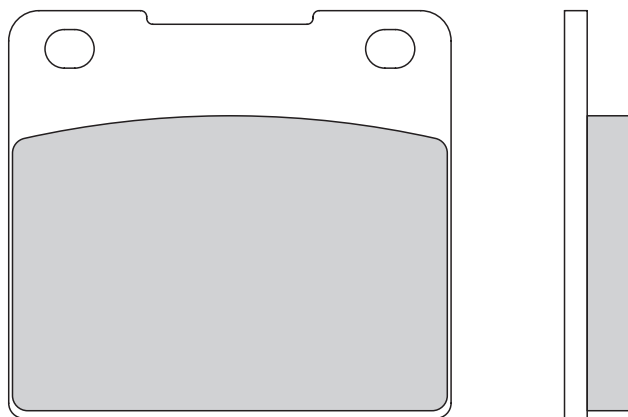
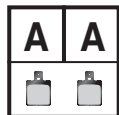

GALFER
FD
022
G1054

↔ 58,5
mm x
↑ 53,9
↔ 9,0

APPLICATIONS

PADS **FD**

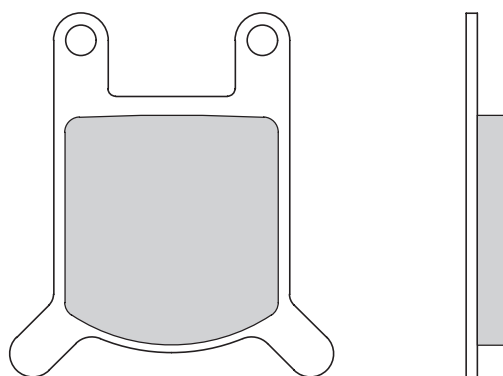
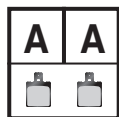

GALFER
FD
031
G1054

↔ 42,8
mm x
↑ 48,1
↔ 5,5

DISCS **DF**

SHOES **MF**

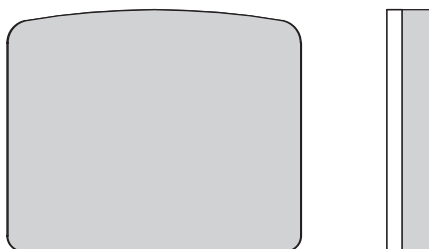
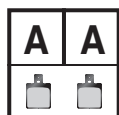

GALFER
FD
042
G1054

↔ 38,9
mm x
↑ 31,9
↔ 6,0

LINES **FK**

BRACKETS **SP**

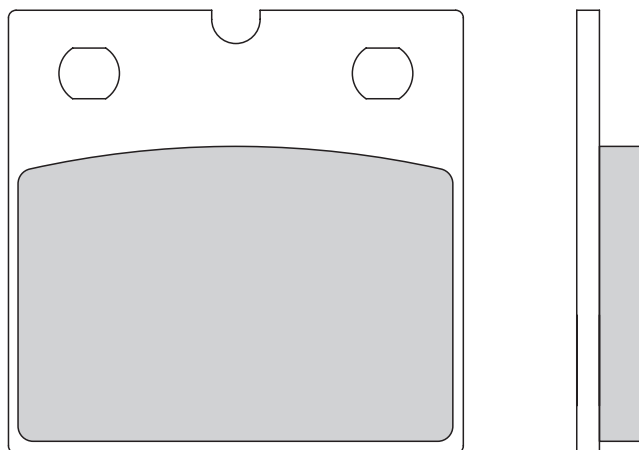
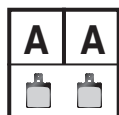

GALFER
FD
044
G1054

↔ 60,15
mm x
↑ 58,6
↔ 9,0

KITS **KG**

CROSS REFERENCE



APPLICATIONS

GALFER
FD
045
G1054

↔ 53,0
mm x
↕ 53,0
↔ 9,0

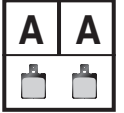
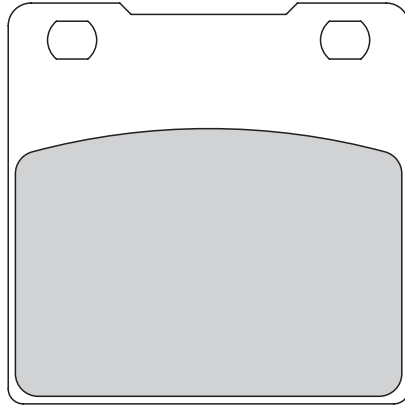

FD111 (th. 8,6mm) can replace FD045 (not vice versa) | FD111 (th. 8,6mm) puede sustituir FD045 (no al revés)

PADS **FD**

DISCS **DF**

GALFER
FD
046
G1054

↔ 75,8
mm x
↕ 50,0
↔ 10,8

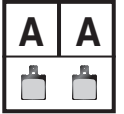
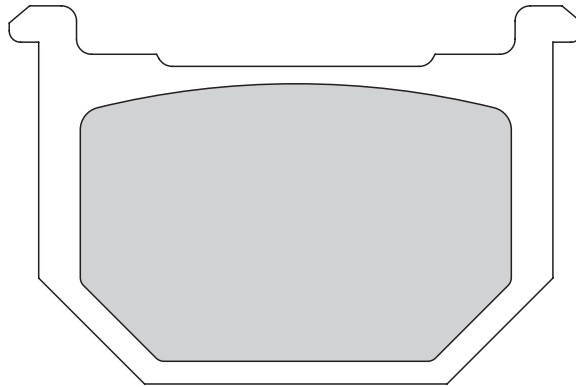

SHOES **MF**

LINES **FK**

GALFER
FD
047
G1054

↔ 72,1
mm x
↕ 45,5
↔ 11,4

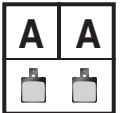
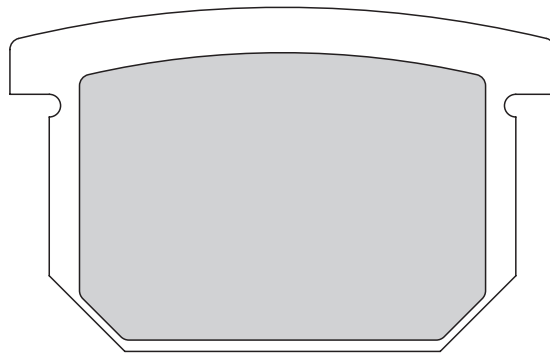

BRACKETS **SP**

KITS **KG**

GALFER
FD
048
G1054
G1050
G1805

↔ 35,9
mm x
↕ 51,5
↔ 6,0

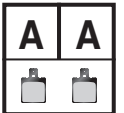
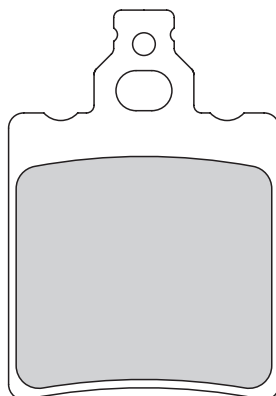

CROSS REFERENCE

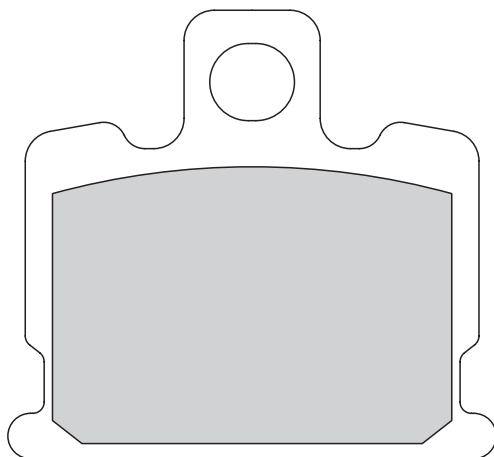
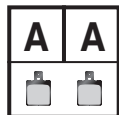

GALFER
FD
051
G1054

64,6
x
59,3
mm

10,0

APPLICATIONS

PADS **FD**

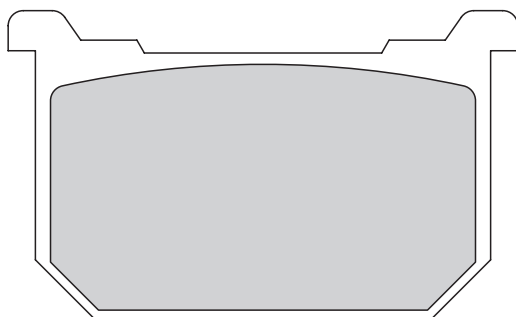
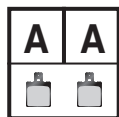

GALFER
FD
052
G1054

67,4
x
40,6
mm

9,5

DISCS **DF**

SHOES **MF**

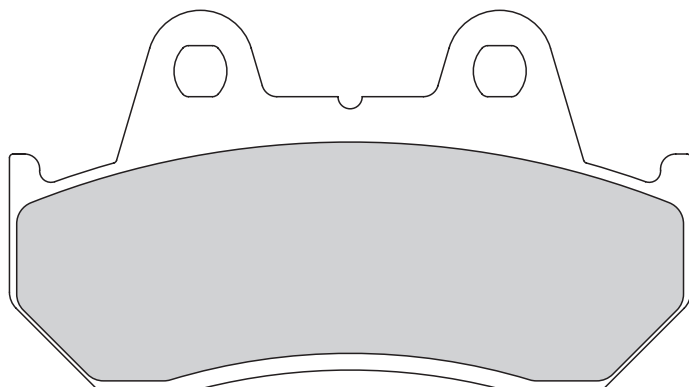
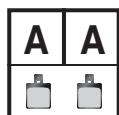

GALFER
FD
054
G1054
G1050
G1370

90,1
x
50,0
mm

10,0

LINES **FK**

BRACKETS **SP**

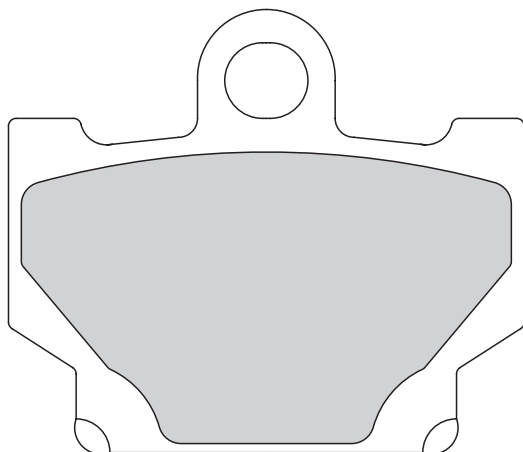
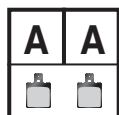

GALFER
FD
056
G1054

68,2
x
58,8
mm

9,5

CROSS REFERENCE



APPLICATIONS

GALFER
FD
057
G1054
G1371

↔ 63,9
mm x
↕ 55,2
↔ 9,0

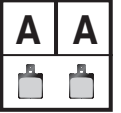
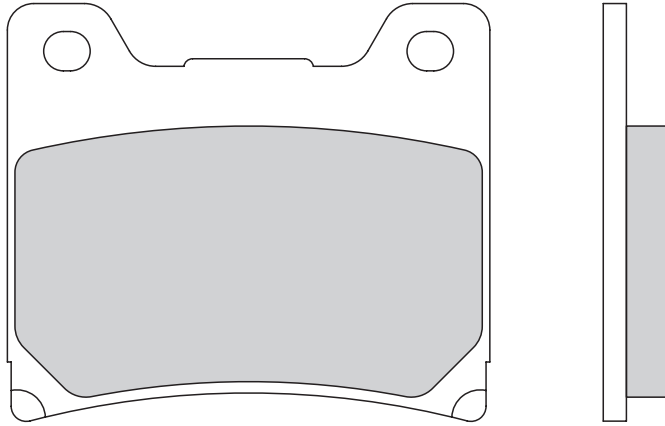

PADS **FD**

DISCS **DF**

GALFER
FD
060
G1054

↔ 92,0
mm x
↕ 53,8
↔ 8,0

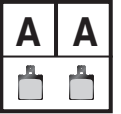
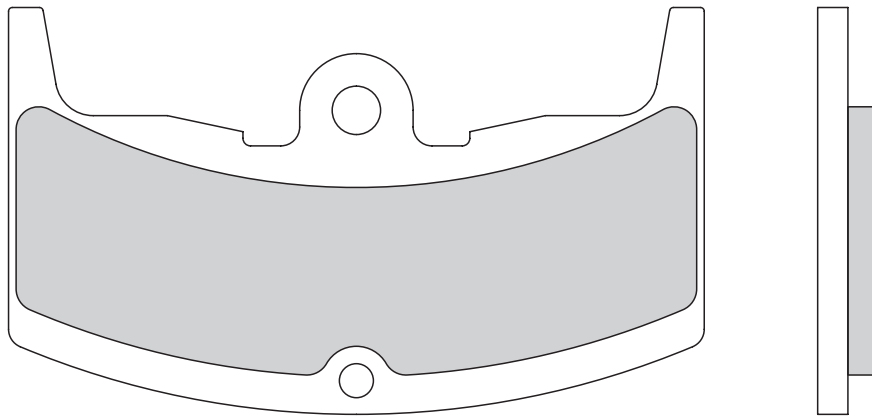

SHOES **MF**

LINES **FK**

GALFER
FD
062
G1054
G1370

↔ 70,0
mm x
↕ 43,5
↔ 10,0

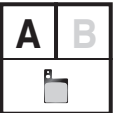
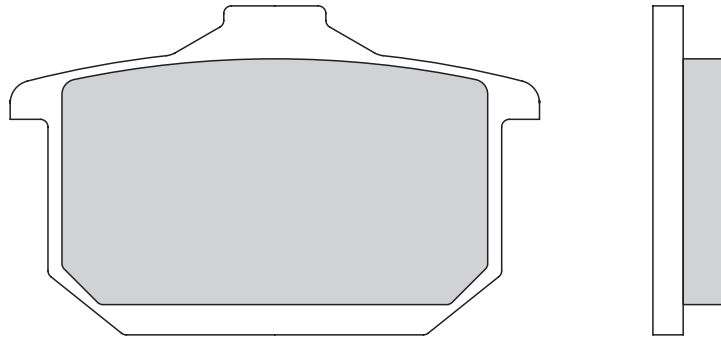

BRACKETS **SP**

KITS **KG**

↔ 110,7
mm x
↕ 51,0
↔ 10,0

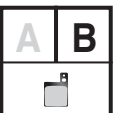
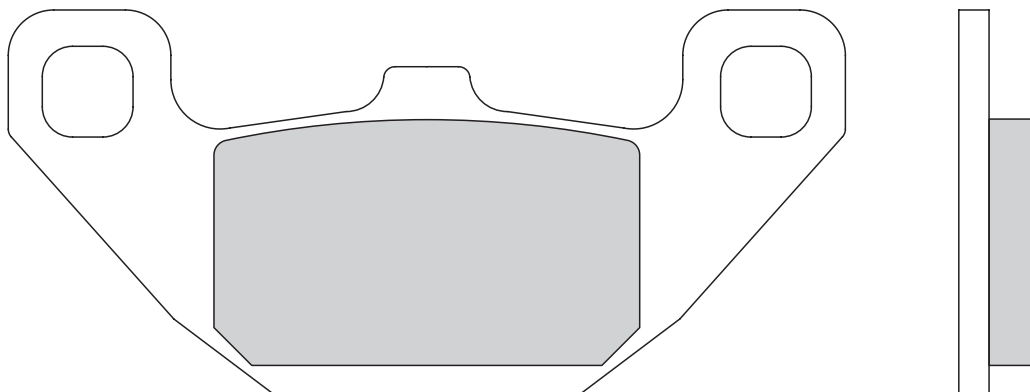

CROSS REFERENCE

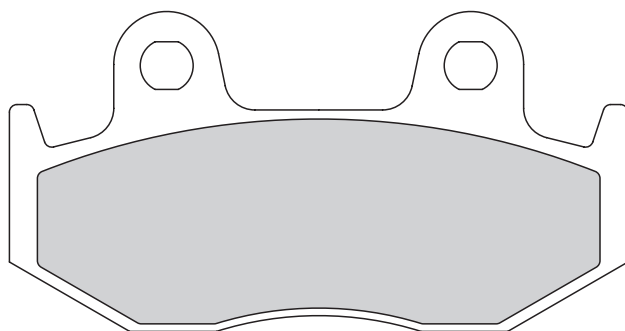
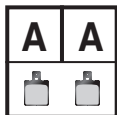

GALFER
FD
063
G1054
G1050
G1805
G1397

81,8
mm x
42,3

7,2

APPLICATIONS

PADS **FD**

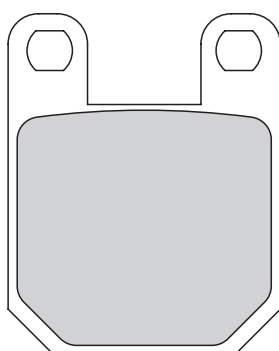
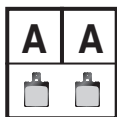

GALFER
FD
065
G1054
G1050
G1805
G1380

36,0
mm x
45,0

6,0

DISCS **DF**

SHOES **MF**

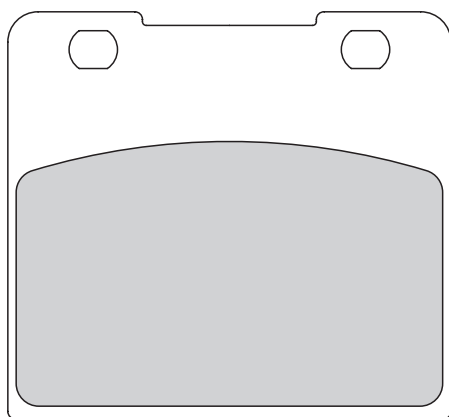
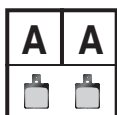

GALFER
FD
066
G1054
G1370

58,6
mm x
53,9

8,6

LINES **FK**

BRACKETS **SP**

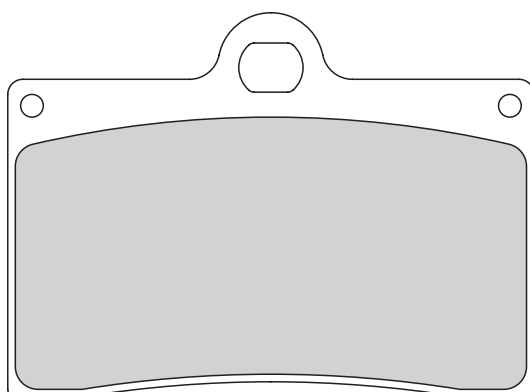
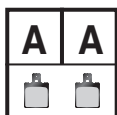

GALFER
FD
068
G1054
G1050
G1370
G1375
G1375R

69,6
mm x
51,0

8,2

KITS **KG**

CROSS REFERENCE



APPLICATIONS

GALFER
FD
069
G1054
G1370

PADS **FD**

68,1
mm x
56,0
9,0

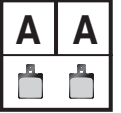
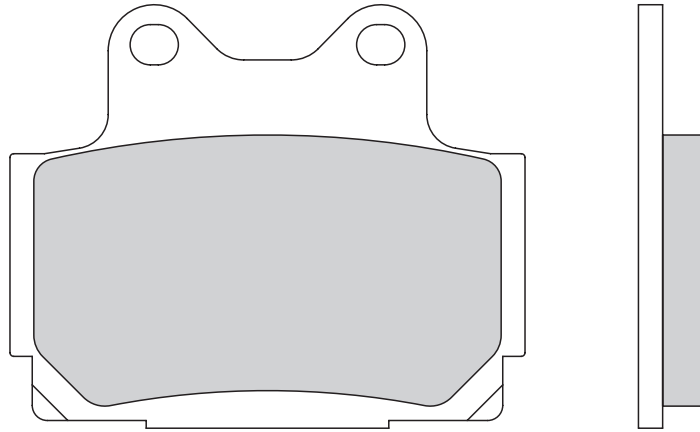

DISCS **DF**

GALFER
FD
070
G1054

SHOES **MF**

77,0
mm x
54,0
9,5

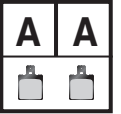
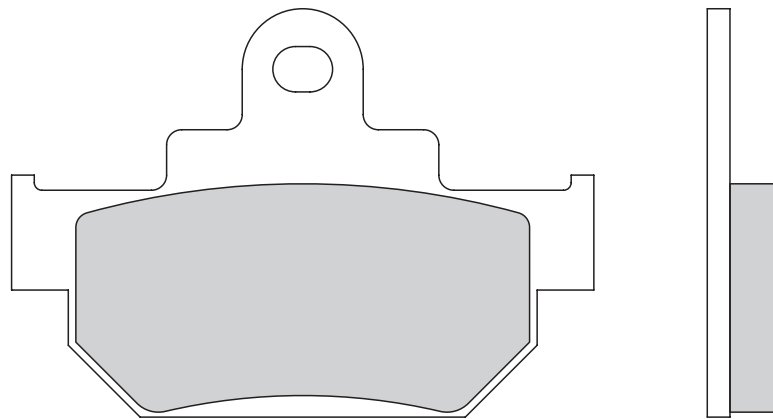

FD209 (th. 7,0mm) can replace **FD070** (not vice versa) | **FD209** (th. 7,0mm) puede sustituir **FD070** (no al revés)

LINES **FK**

GALFER
FD
071
G1054
G1805

BRACKETS **SP**

31,6
mm x
52,1
5,5

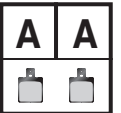
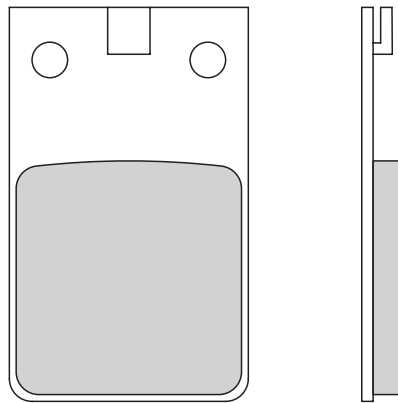

KITS **KG**

GALFER
FD
072
G1054

CROSS REFERENCE

70,8
mm x
39,0
10,0

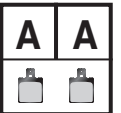
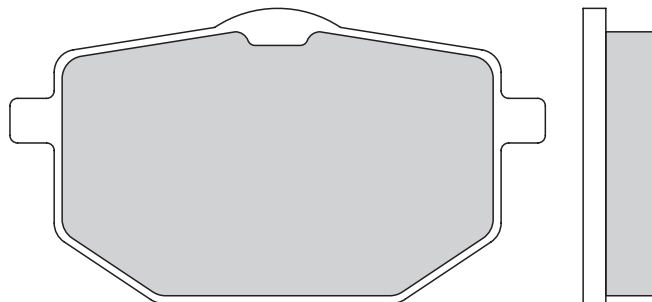

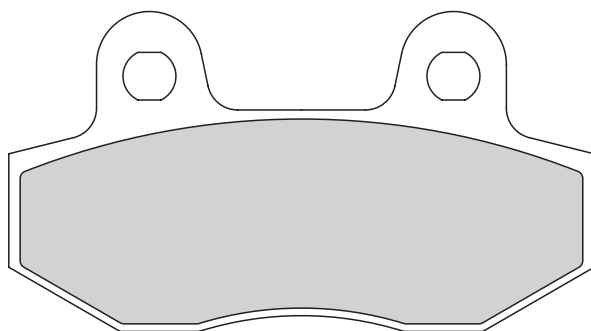
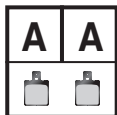

GALFER
FD
073
G1054
G1050
G1805
G1370

77,4
mm x
42,3

7,0

APPLICATIONS

PADS **FD**

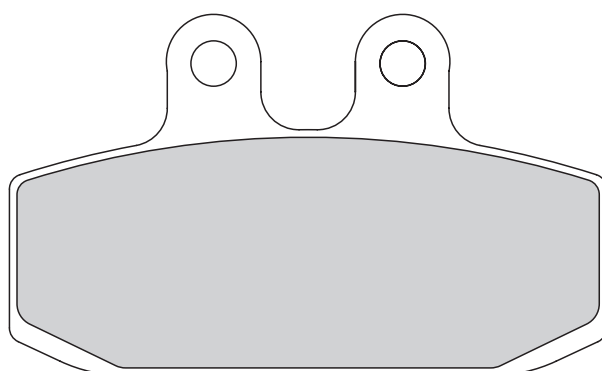
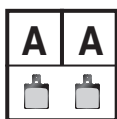

GALFER
FD
074
G1054
G1050
G1805
G1370

79,0
mm x
47,8

7,0

DISCS **DF**

SHOES **MF**

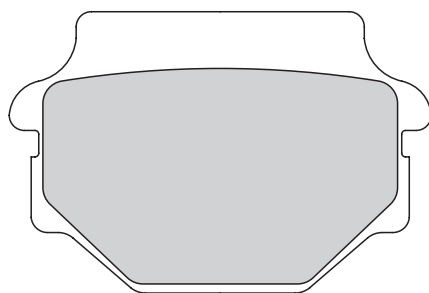
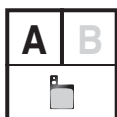

GALFER
FD
075
G1054
G1050
G1805
G1396

55,8
mm x
37,2

10,0

LINES **FK**

BRACKETS **SP**

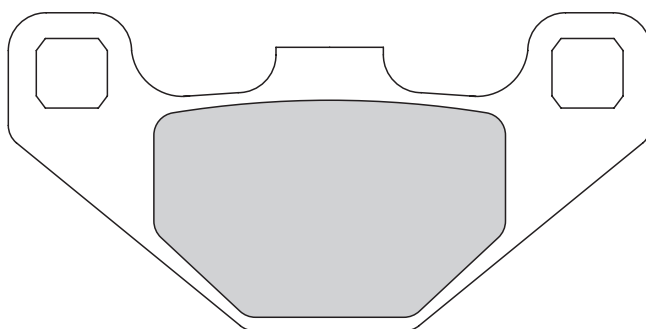
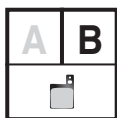

85,0
mm x
42,1

8,0

KITS **KG**

CROSS REFERENCE



APPLICATIONS

GALFER
FD
076
G1054
G1805
G1396
G1397

↔ 46,4
mm x
↕ 45,3
↔ 7,8

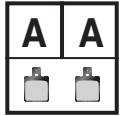
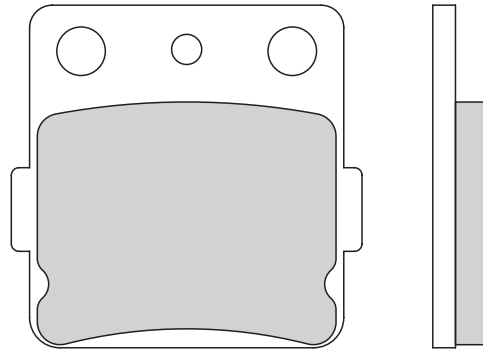

FD299 (th. 6,5mm) can replace FD076 (not vice versa) | FD299 (th. 6,5mm) puede sustituir FD076 (no al revés)

DISCS DF

GALFER
FD
078
G1054

↔ 58,6
mm x
↕ 53,9
↔ 8,6

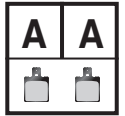
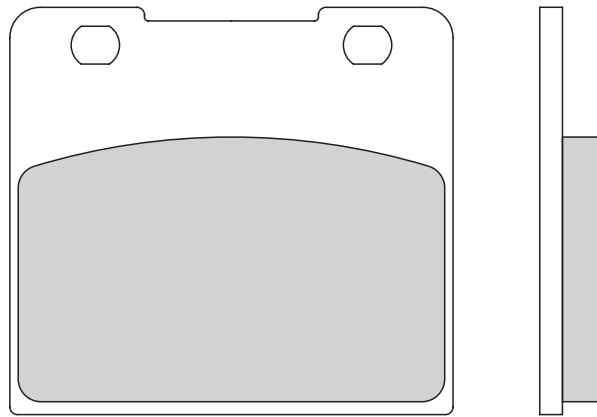

SHOES MF

LINES FK

GALFER
FD
079
G1054
G1050
G1805
G1370

↔ 71,3
mm x
↕ 36,2
↔ 8,5

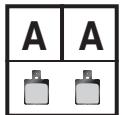
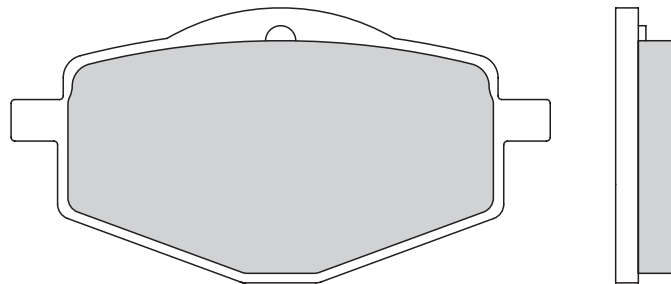

BRACKETS SP

KITS KG

GALFER
FD
080
G1054

↔ 91,3
mm x
↕ 29,9
↔ 7,0

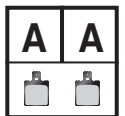
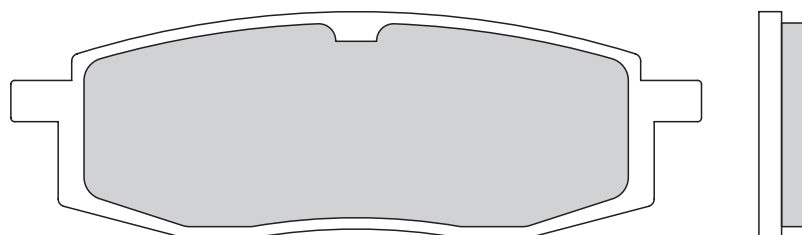

CROSS REFERENCE

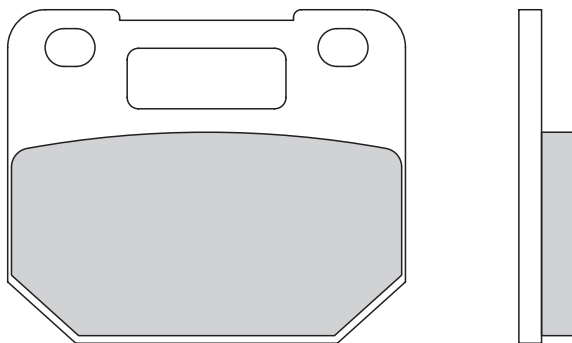
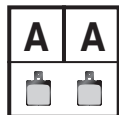

GALFER
FD
081
G1054
G1370

↔ 52,6
mm x
↑↓ 44,1
↔ 7,5

APPLICATIONS

PADS **FD**

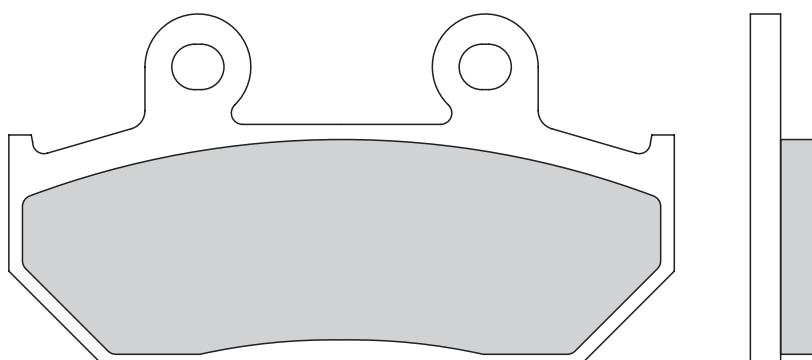
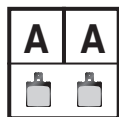

GALFER
FD
082
G1054
G1370

↔ 88,0
mm x
↑↓ 46,0
↔ 9,0

DISCS **DF**

SHOES **MF**

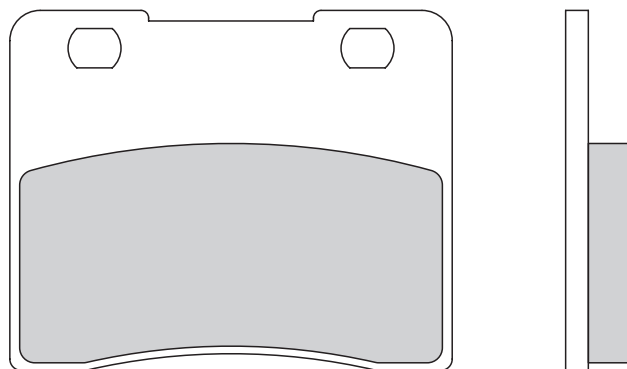
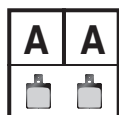

GALFER
FD
083
G1054

↔ 58,5
mm x
↑↓ 47,6
↔ 8,7

LINES **FK**

BRACKETS **SP**

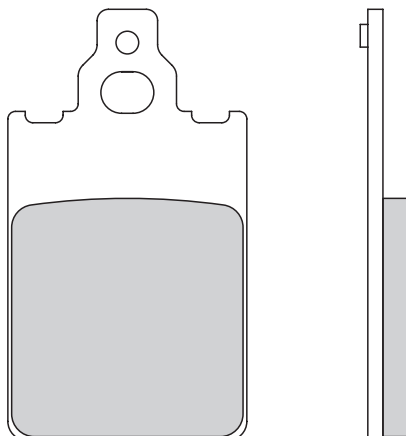
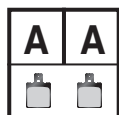

GALFER
FD
084
G1054
G1050
G1805

↔ 31,6
mm x
↑↓ 57,0
↔ 5,5

KITS **KG**

CROSS REFERENCE



APPLICATIONS

GALFER
FD
085
G1054
G1050

↔ 67,5
mm x
↕ 50,7
↔ 7,5

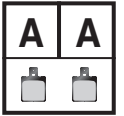
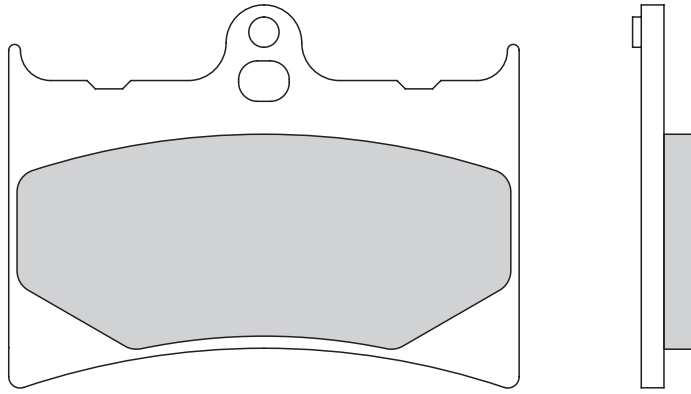

PADS **FD**

DISCS **DF**

GALFER
FD
086
G1054
G1805
G1370
G1396
G1397

↔ 77,4
mm x
↕ 42,3
↔ 7,7

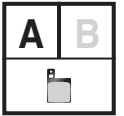
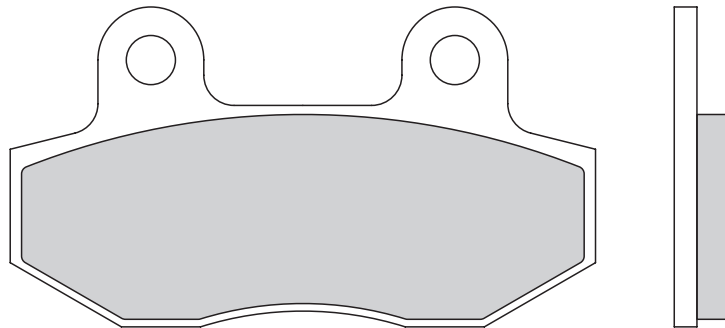

SHOES **MF**

LINES **FK**

↔ 98,8
mm x
↕ 42,3
↔ 7,5

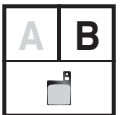
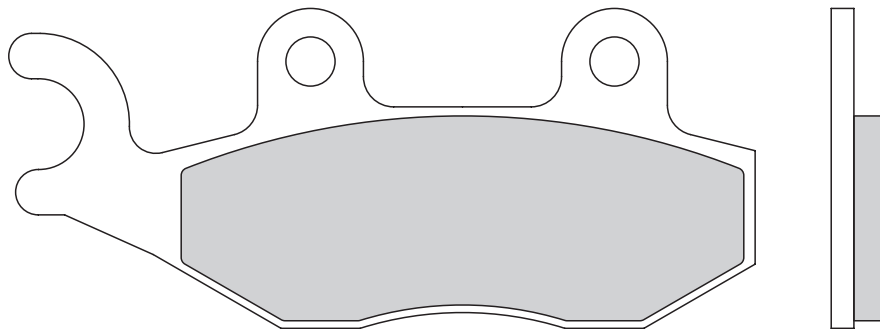

BRACKETS **SP**

KITS **KG**

GALFER
FD
087
G1054
G1370

↔ 74,8
mm x
↕ 54,3
↔ 8,2

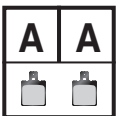
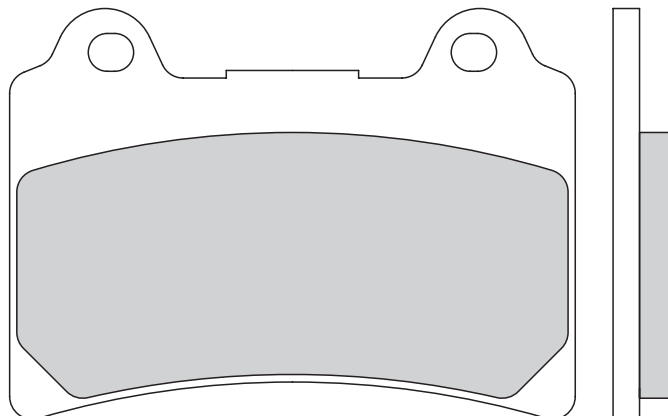

CROSS REFERENCE

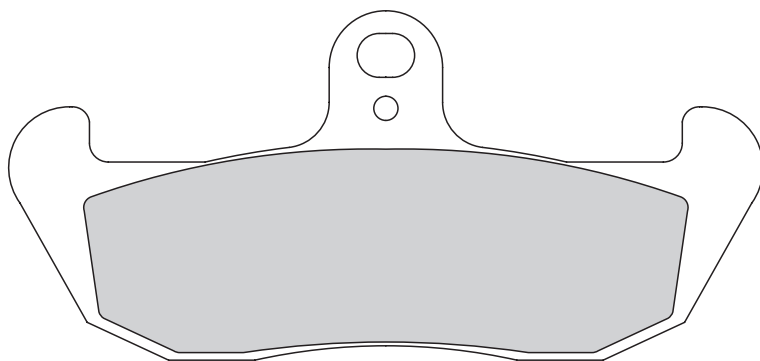
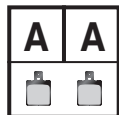

GALFER
FD
089
G1054

↔ 99,8
mm x
↕ 46,2

⏏ 8,3

APPLICATIONS

PADS **FD**

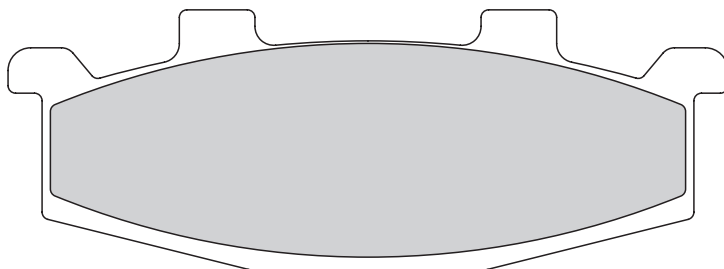
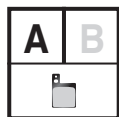

GALFER
FD
090
G1054
G1370

↔ 95,2
mm x
↕ 34,4

⏏ 8,8

DISCS **DF**

SHOES **MF**

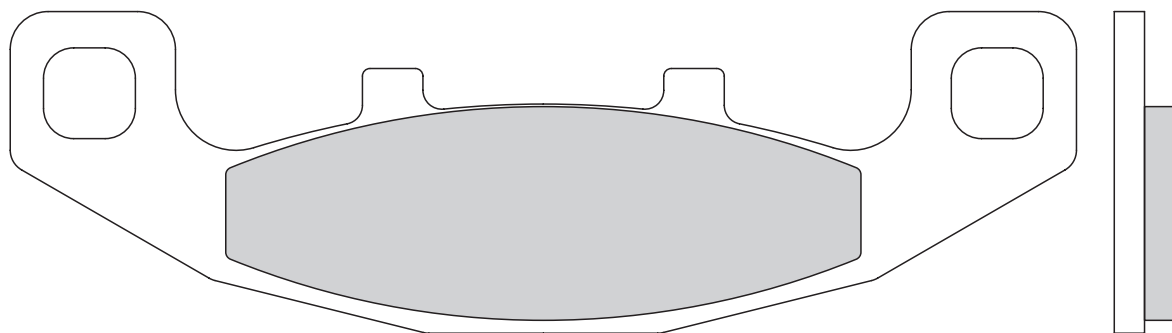
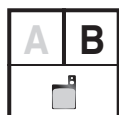

↔ 141,0
mm x
↕ 42,4

⏏ 8,3

LINES **FK**

BRACKETS **SP**

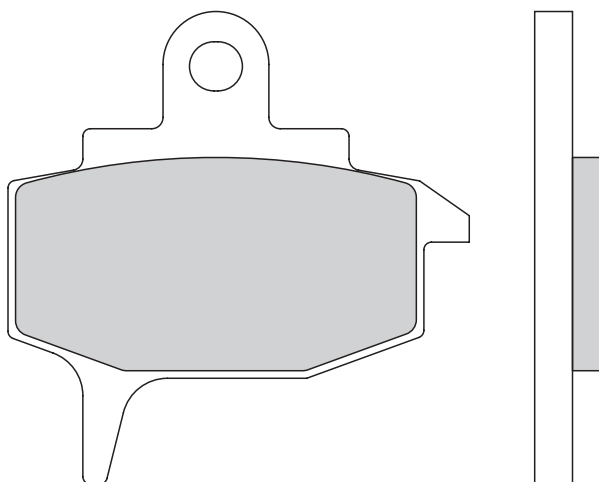
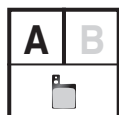

GALFER
FD
091
G1054

↔ 61,0
mm x
↕ 62,5

⏏ 9,6

KITS **KG**

CROSS REFERENCE



APPLICATIONS

	74,0
mm	x
	48,5
	7,2

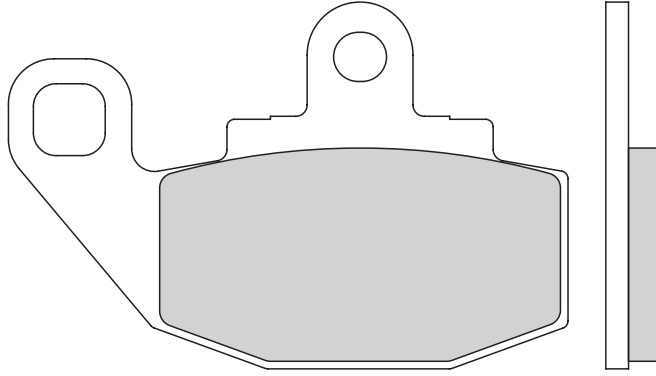
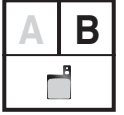

PADS **FD**

DISCS **DF**

GALFER	
FD	
092	
G1054	
G1805	
G1396	

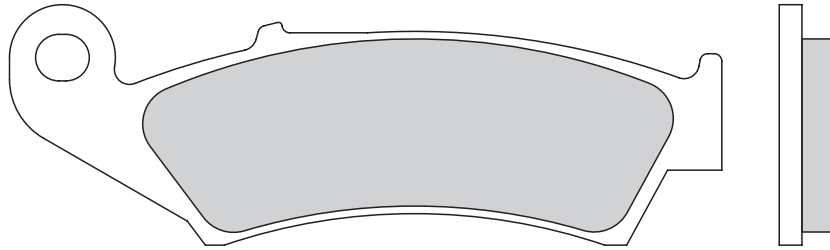
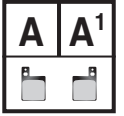

SHOES **MF**

	94,2
mm	x
	31,8
	7,4

LINES **FK**

GALFER	
FD	
093	
G1054	
G1805	
G1396	

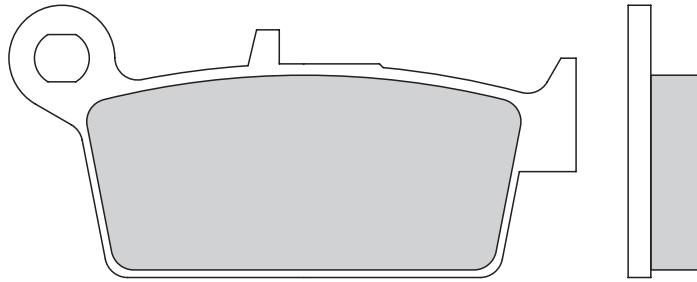
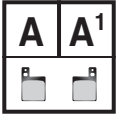

BRACKETS **SP**

	75,0
mm	x
	36,0
	10,0

FD147 (th. 7,0mm) can replace FD093 (not vice versa) | FD147 (th. 7,0mm) puede sustituir FD093 (no al revés)

KITS **KG**

GALFER	
FD	
094	
G1054	
G1050	
G1805	
G1396	
G1380	

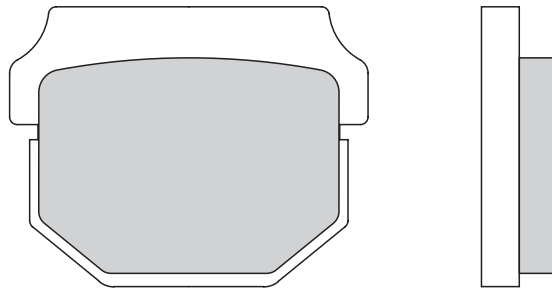
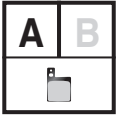

CROSS REFERENCE

	47,4
mm	x
	37,0
	10,0

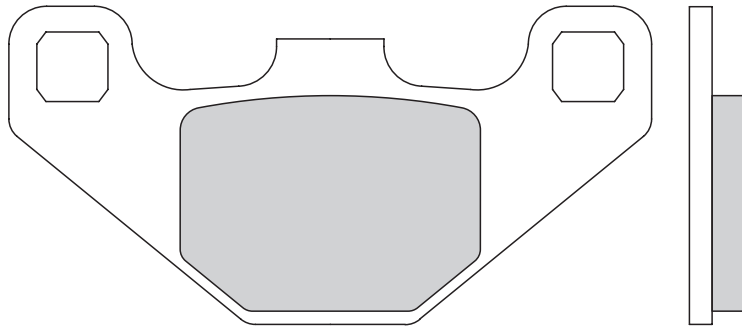
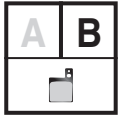

↔	85,0
mm	x
↑	42,1
↔	7,8

APPLICATIONS

PADS FD

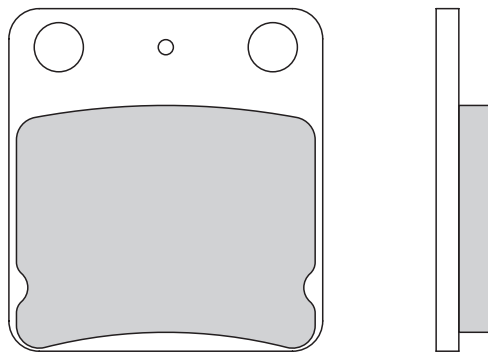
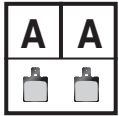

GALFER
FD
095
G1054
G1050
G1805
G1396
G1397

↔	41,5
mm	x
↑	45,3
↔	7,7

DISCS DF

SHOES MF

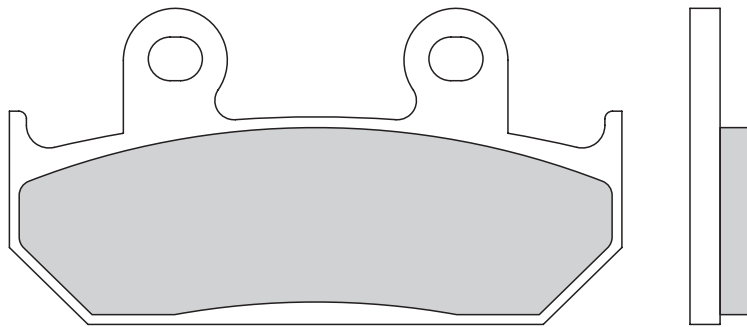
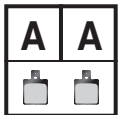

GALFER
FD
096
G1054
G1370

↔	81,0
mm	x
↑	41,8
↔	9,0

LINES FK

BRACKETS SP

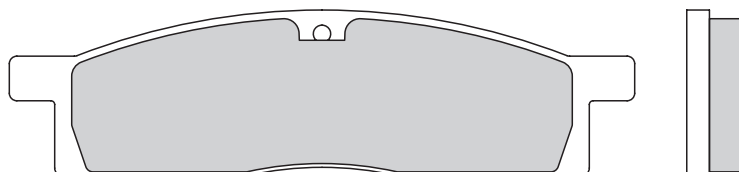
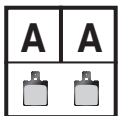

GALFER
FD
097
G1054
G1050
G1805
G1396

↔	82,7
mm	x
↑	21,9
↔	7,3

KITS KG

CROSS REFERENCE



APPLICATIONS

GALFER
FD
098
G1054

120,0
x
52,0
8,0

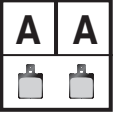
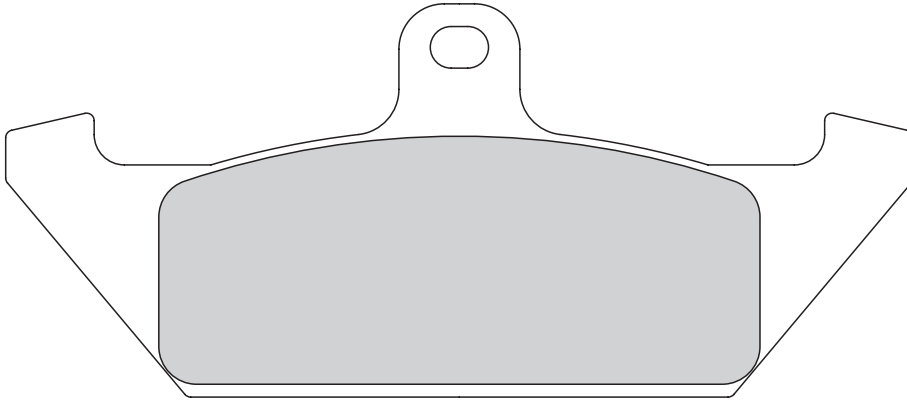

PADS **FD**

DISCS **DF**

GALFER
FD
099
G1054
G1370
G1375

69,9
x
54,4
8,5

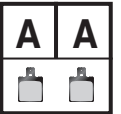
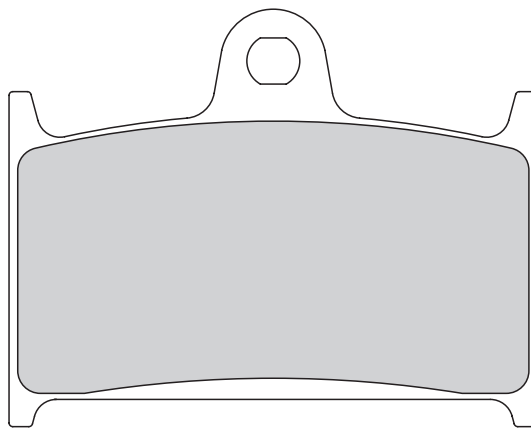

SHOES **MF**

LINES **FK**

GALFER
FD
100
G1054

68,0
x
53,6
9,0

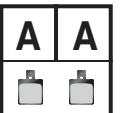
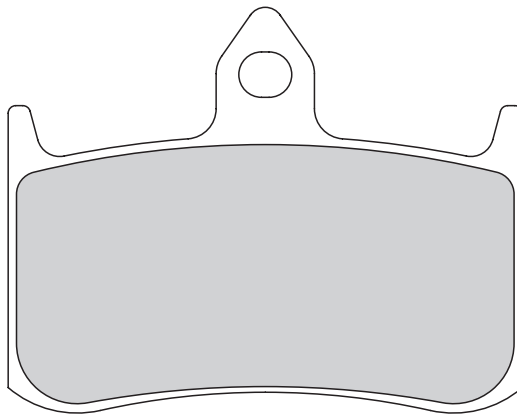

BRACKETS **SP**

FD148 (th. 8,5mm) can replace FD100 (not vice versa) | FD148 (th. 8,5mm) puede sustituir FD100 (no al revés)

KITS **KG**

GALFER
FD
101
G1054

97,5
x
58,0
10,8

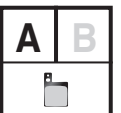
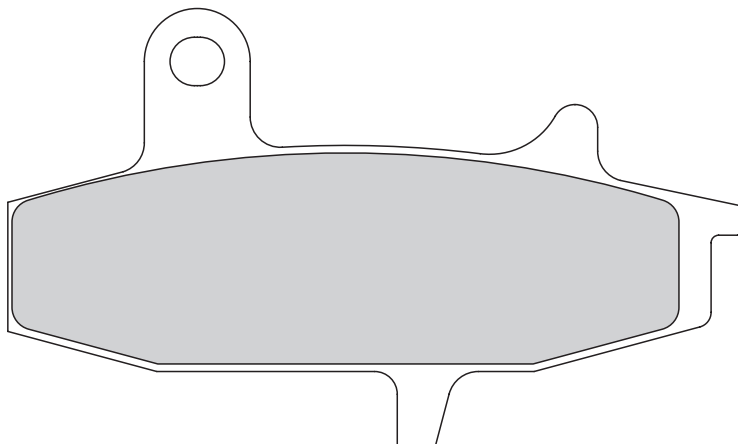

CROSS REFERENCE

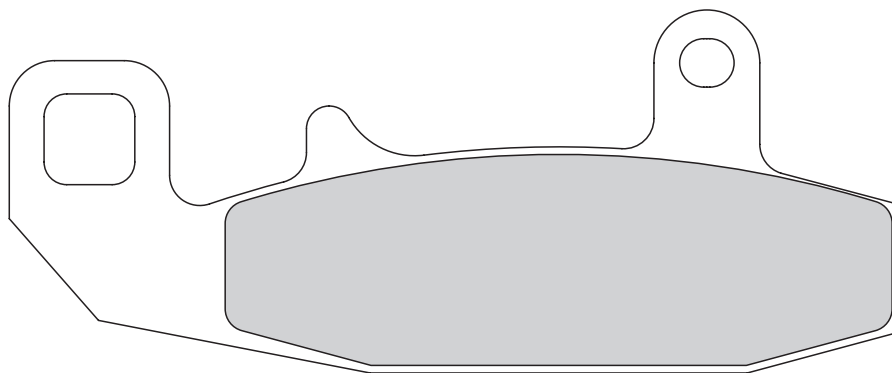
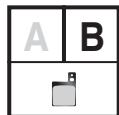

↔	117,3
mm	x
↑	48,0
↔	8,5

APPLICATIONS

PADS **FD**

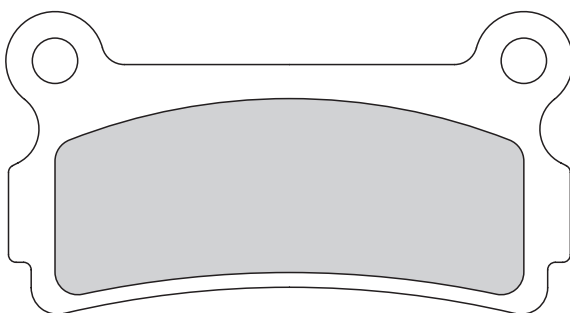
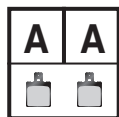

GALFER
FD
102
G1054
G1805

↔	75,0
mm	x
↑	40,0
↔	6,3

DISCS **DF**

SHOES **MF**

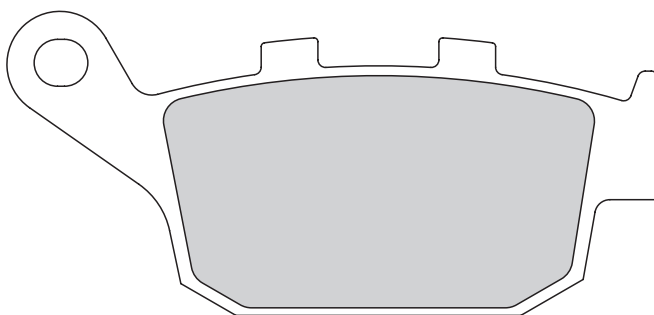
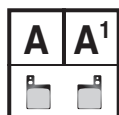

GALFER
FD
103
G1054
G1805
G1371

↔	86,0
mm	x
↑	40,2
↔	10,6

LINES **FK**

BRACKETS **SP**

FD457 (th. 9,0mm) can replace **FD103** (not vice versa) | FD457 (th. 9,0mm) puede sustituir **FD103** (no al revés)

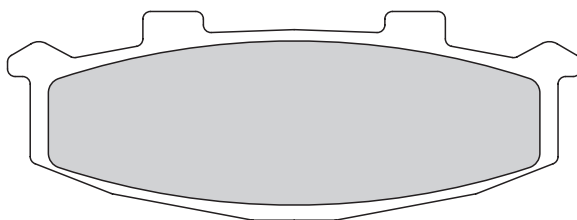
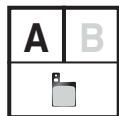

GALFER
FD
104
G1054

↔	75,8
mm	x
↑	27,6
↔	10,0

KITS **KG**

CROSS REFERENCE



APPLICATIONS

↔	106,0
mm	x
↕	38,6
↔	7,5

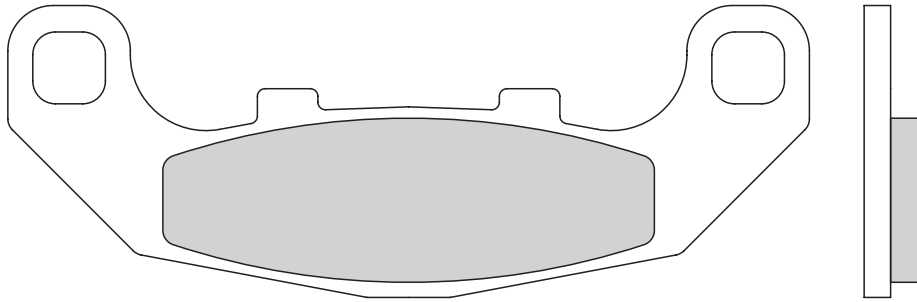
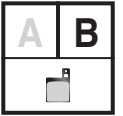

PADS **FD**

DISCS **DF**

GALFER	
FD	
107	
G1054	
G1370	
G1375	

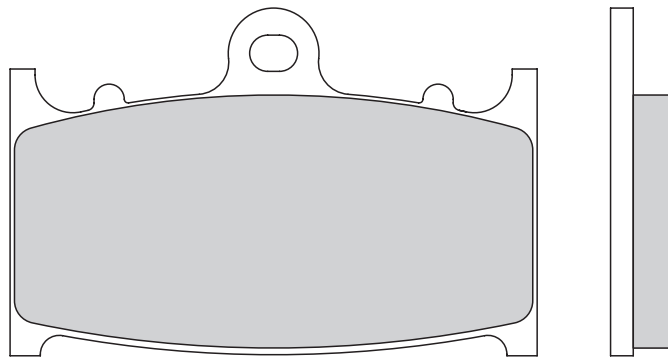
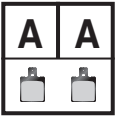

SHOES **MF**

↔	69,7
mm	x
↕	46,0
↔	8,5

LINES **FK**

GALFER	
FD	
109	
G1054	
G1805	

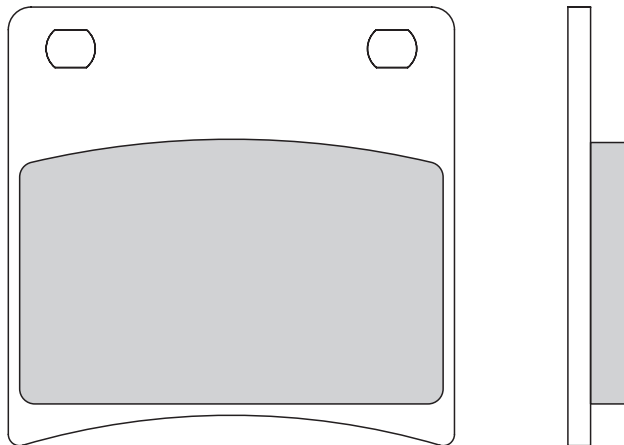
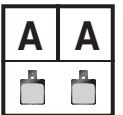

BRACKETS **SP**

↔	59,0
mm	x
↕	58,0
↔	8,0

KITS **KG**

GALFER	
FD	
110	
G1054	
G1805	

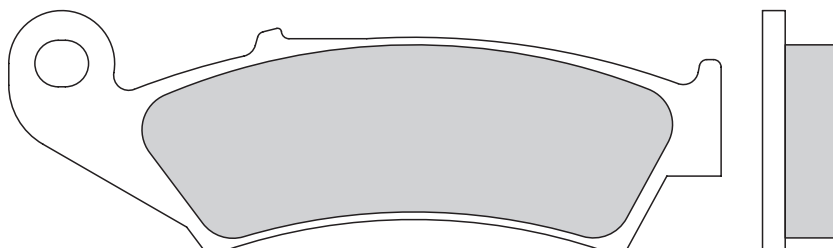
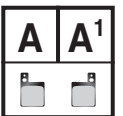

CROSS REFERENCE

↔	94,2
mm	x
↕	31,8
↔	10,5

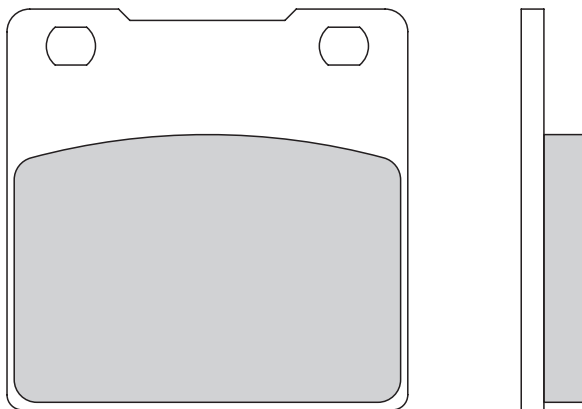
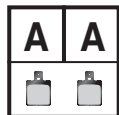

GALFER
FD
111
G1054
G1805
G1371

↔ 53,0
mm x
↑↓ 53,0
↔ 8,6

APPLICATIONS

PADS **FD**

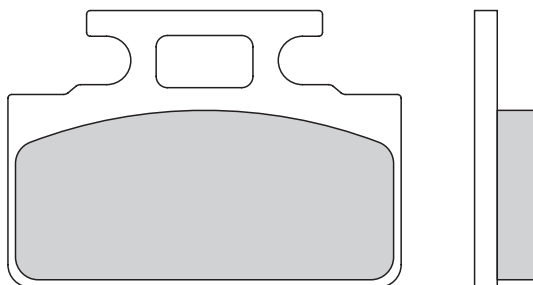
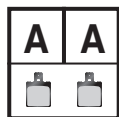

GALFER
FD
113
G1054
G1050

↔ 52,0
mm x
↑↓ 36,6
↔ 8,3

DISCS **DF**

SHOES **MF**

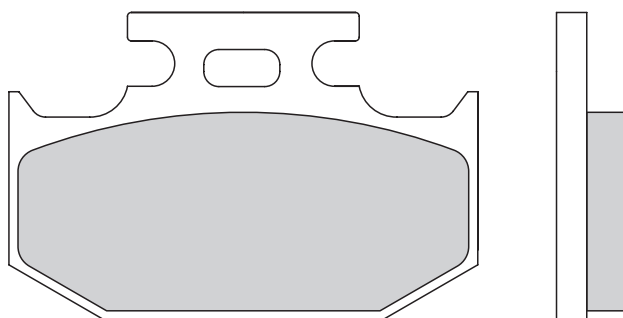
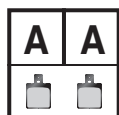

GALFER
FD
114
G1054
G1805
G1396

↔ 62,0
mm x
↑↓ 40,6
↔ 9,5

LINES **FK**

BRACKETS **SP**

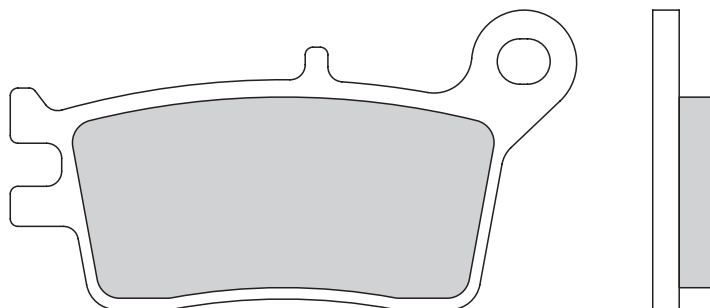
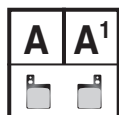

GALFER
FD
115
G1054

↔ 74,9
mm x
↑↓ 39,6
↔ 8,5

KITS **KG**

CROSS REFERENCE



APPLICATIONS

GALFER
FD
117
G1054
G1050
G1805
G1370-97
G1375/R

↔ 77,4
mm x
↑↓ 42,3
↔ 7,7

↔ 96,8
mm x
↑↓ 42,4
↔ 7,5

PADS **FD**

DISCS **DF**

SHOES **MF**

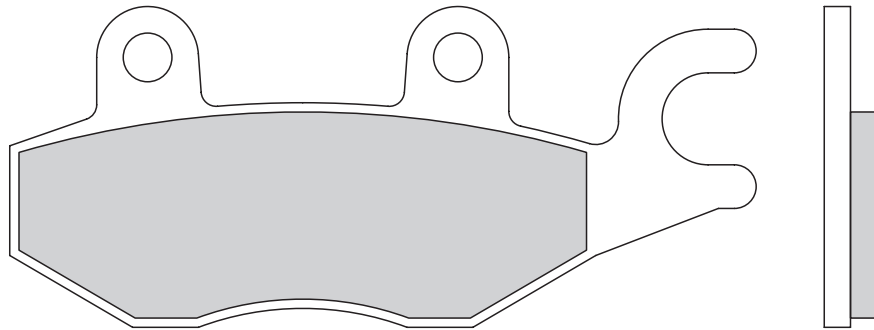
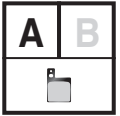
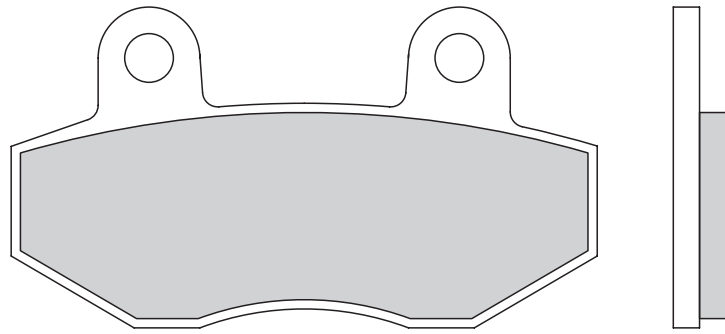

LINES **FK**

GALFER
FD
118
G1054
G1050
G1370

↔ 67,4
mm x
↑↓ 50,7
↔ 7,0

BRACKETS **SP**

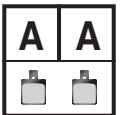
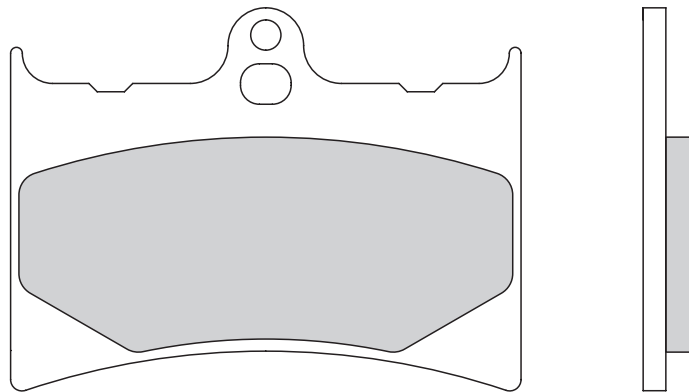

KITS **KG**

GALFER
FD
119
G1054

↔ 99,6
mm x
↑↓ 52,0
↔ 8,0

CROSS REFERENCE

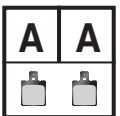
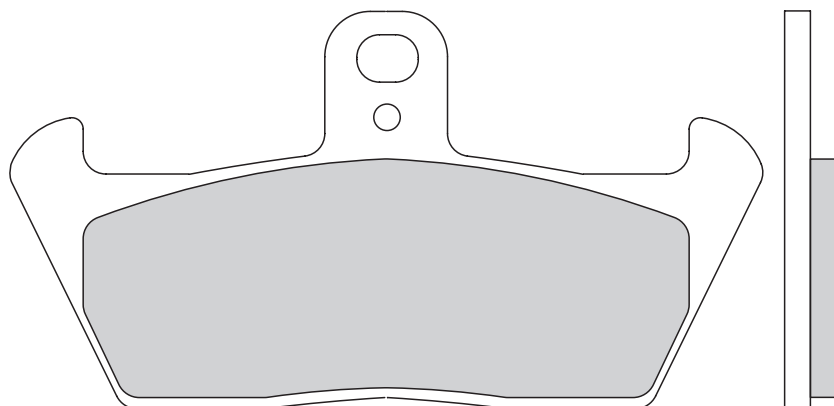

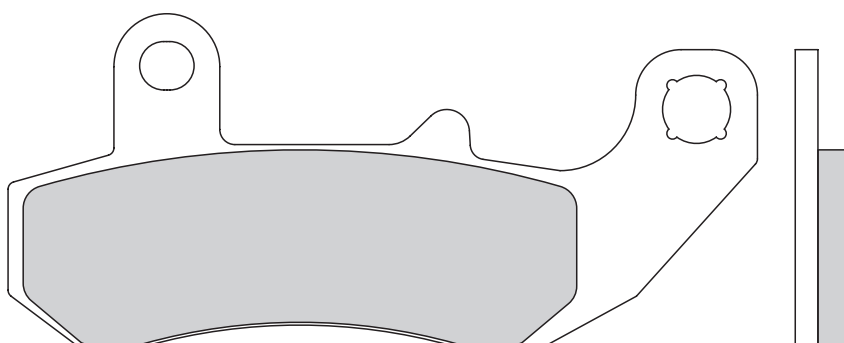
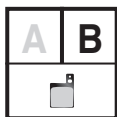
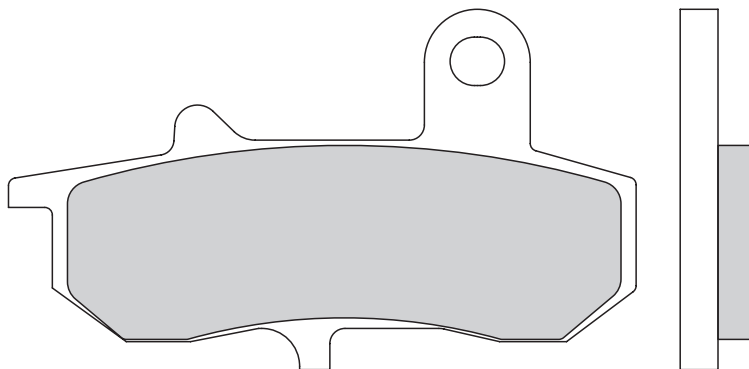
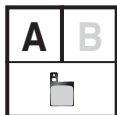

GALFER
FD
120
G1054
G1805

83,0
x
47,6
mm

9,6

99,1
x
44,0
mm

7,4

APPLICATIONS

PADS FD

DISCS DF

SHOES MF

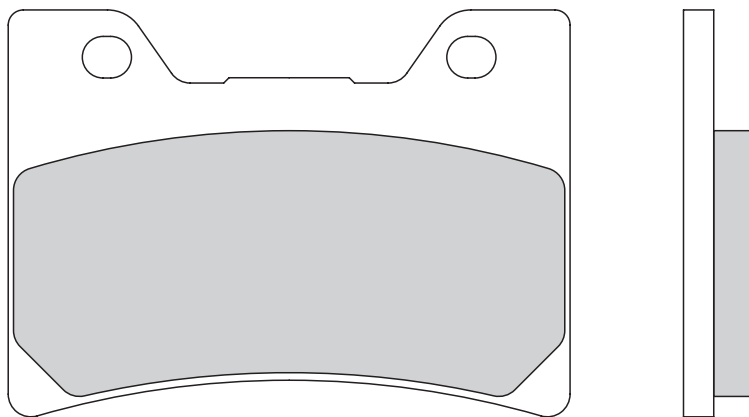
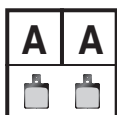

GALFER
FD
121
G1054

74,3
x
53,8
mm

9,2

LINES FK

BRACKETS SP

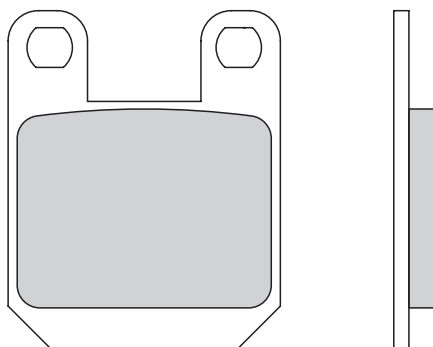
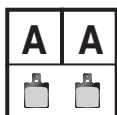

GALFER
FD
122
G1054
G1805

36,0
x
45,0
mm

6,0

KITS KG

CROSS REFERENCE



APPLICATIONS

GALFER
FD
123
G1054
G1805

PADS **FD**

↔ 39,8
mm x
↕ 56,3
↔ 7,0

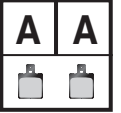
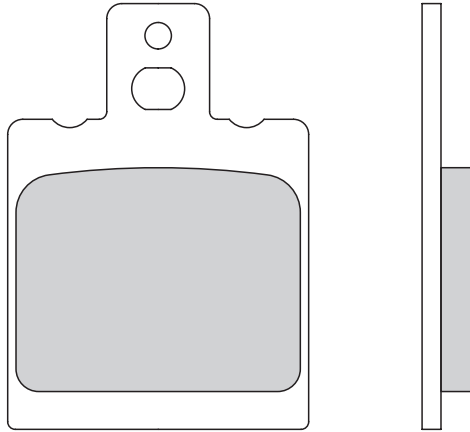

DISCS **DF**

GALFER
FD
124
G1054

SHOES **MF**

↔ 59,0
mm x
↕ 61,5
↔ 13,0

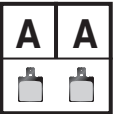
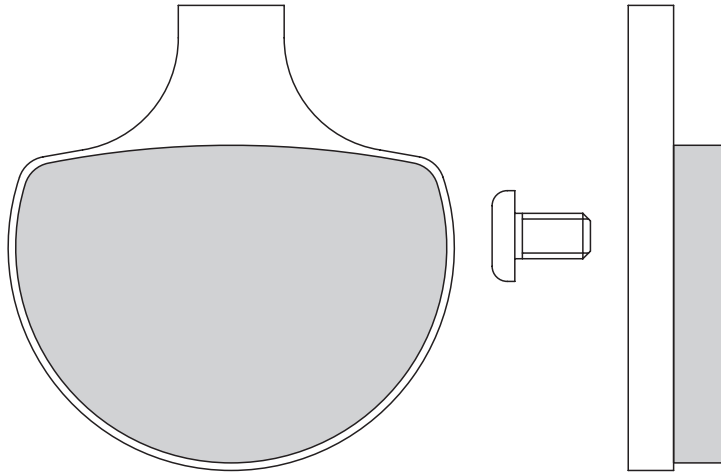

LINES **FK**

GALFER
FD
125
G1054

BRACKETS **SP**

↔ 103,4
mm x
↕ 62,5
↔ 12,0

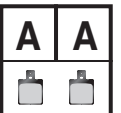
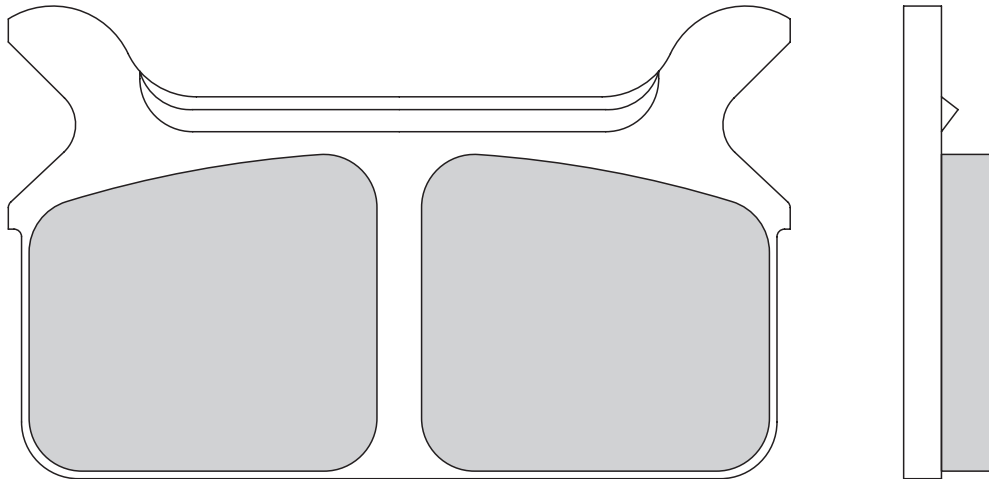

KITS **KG**

GALFER
FD
126
G1054

CROSS REFERENCE

↔ 104,0
mm x
↕ 62,3
↔ 11,0

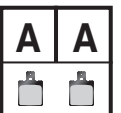
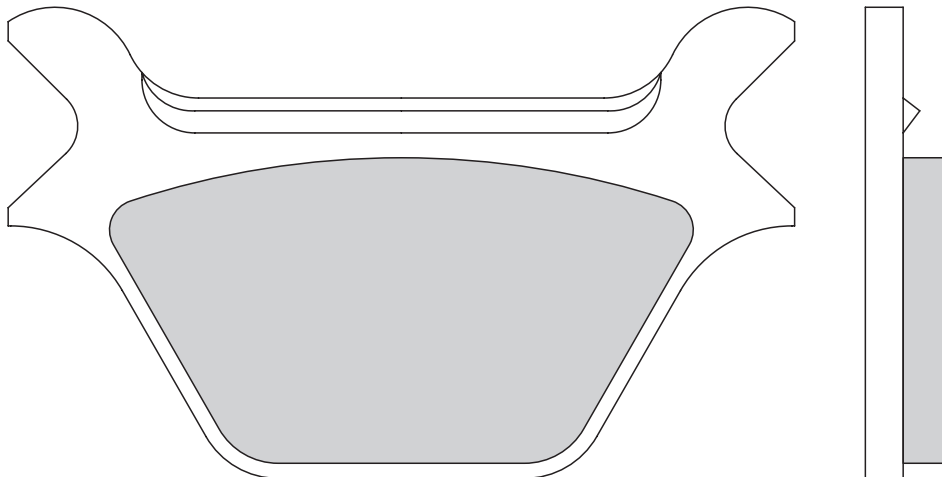

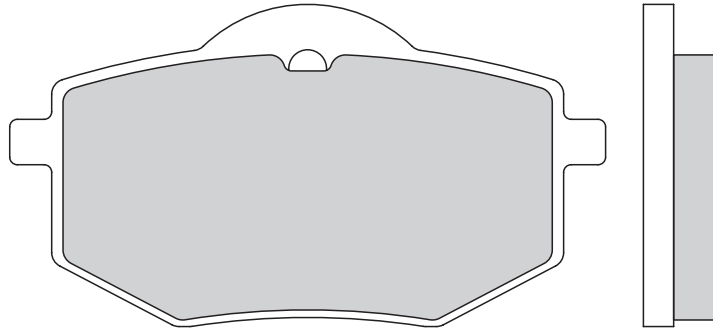
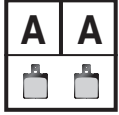

GALFER
FD
127
G1054

78,8
mm x
42,6

10,6

APPLICATIONS

PADS **FD**

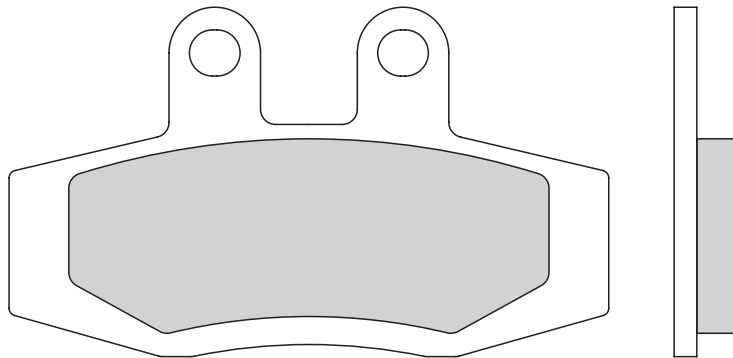
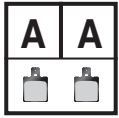

GALFER
FD
128
G1054
G1805

79,3
mm x
46,2

9,0

DISCS **DF**

SHOES **MF**

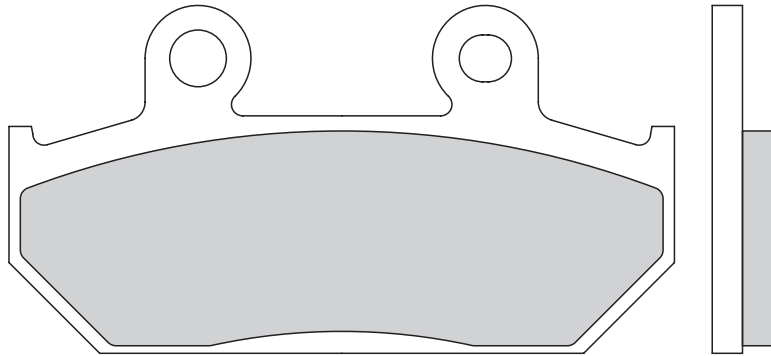

GALFER
FD
129
G1054
G1805

88,0
mm x
46,0

9,0

LINES **FK**

BRACKETS **SP**

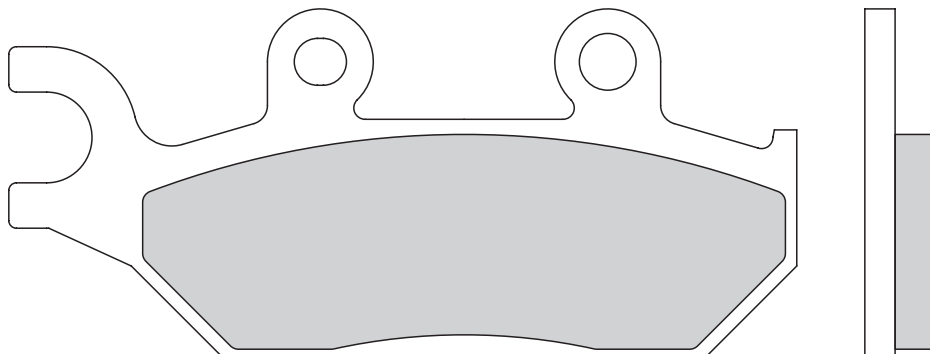

104,2
mm x
46,0

10,0

KITS **KG**

CROSS REFERENCE



APPLICATIONS

GALFER
FD
130
G1054

↔ 55,0
mm x
↕ 52,6
↔ 9,4

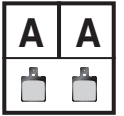
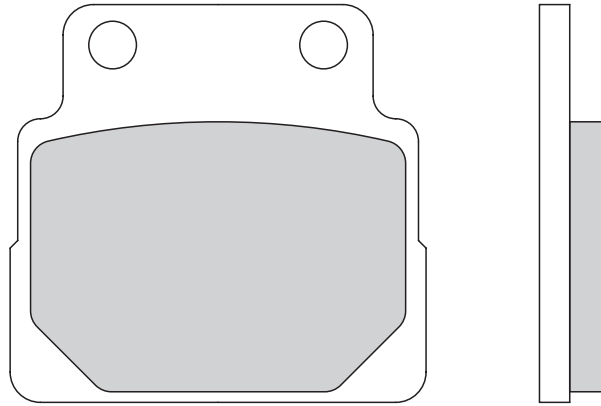

PADS **FD**

DISCS **DF**

GALFER
FD
132
G1054

↔ 87,2
mm x
↕ 52,9
↔ 7,5

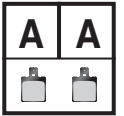
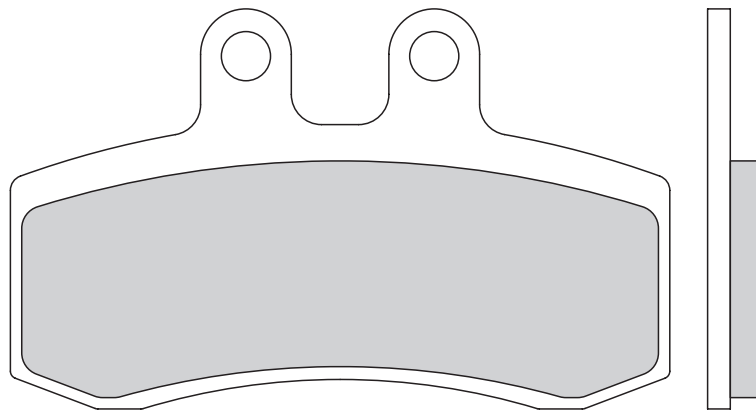

SHOES **MF**

LINES **FK**

GALFER
FD
133
G1054
G1050
G1805
G1380

↔ 76,8
mm x
↕ 41,8
↔ 7,4

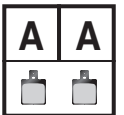
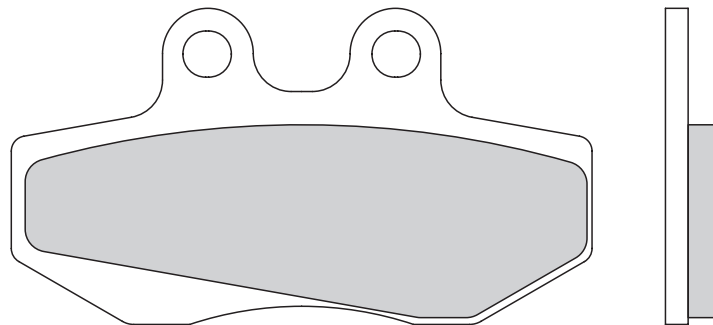

BRACKETS **SP**

KITS **KG**

GALFER
FD
134
G1054
G1371

↔ 86,0
mm x
↕ 36,7
↔ 9,0

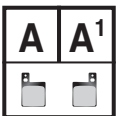
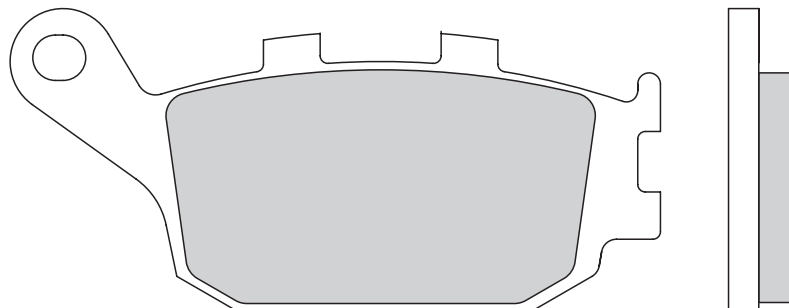

CROSS REFERENCE

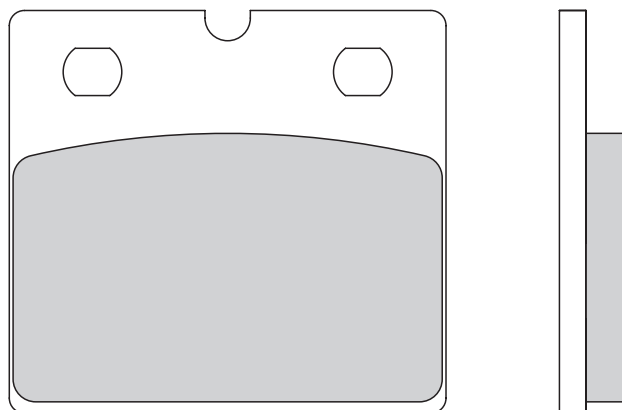
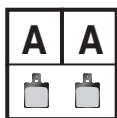
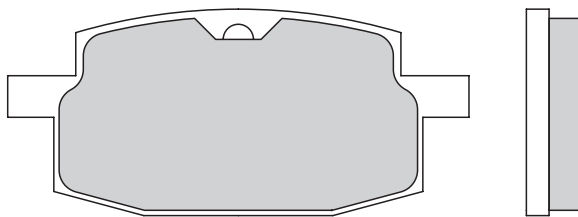
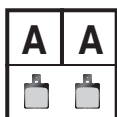
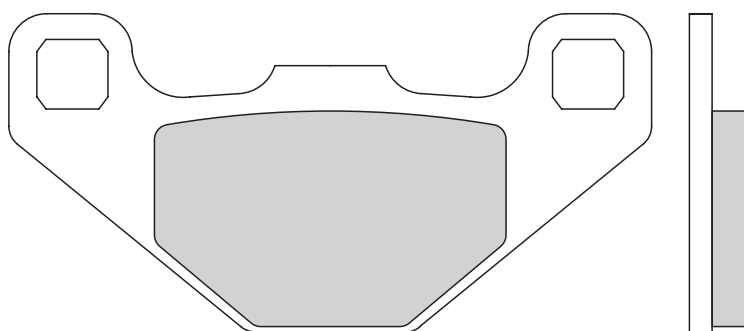
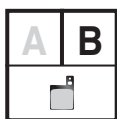
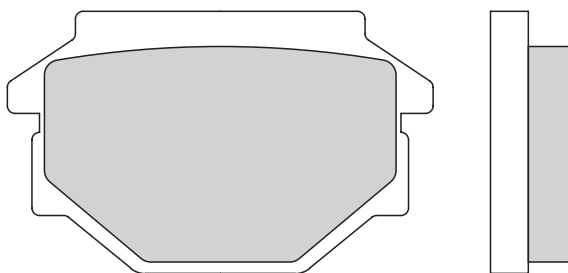
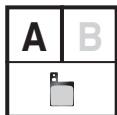

GALFER
FD
135
G1054
G1050

56,3
x
34,7
mm

10,5

85,0
x
42,1
mm

7,8

GALFER
FD
136
G1054
G1050

61,0
x
27,3
mm

7,3

GALFER
FD
137
G1054

57,7
x
53,3
mm

8,8

APPLICATIONS

PADS **FD**

DISCS **DF**

SHOES **MF**

LINES **FK**

BRACKETS **SP**

KITS **KG**

CROSS REFERENCE



APPLICATIONS

GALFER
FD
138
G1054
G1050
G1805
G1370-80
G1396/R

↔ 94,0
mm x
↕ 36,7
↔ 7,6

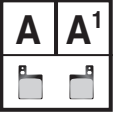
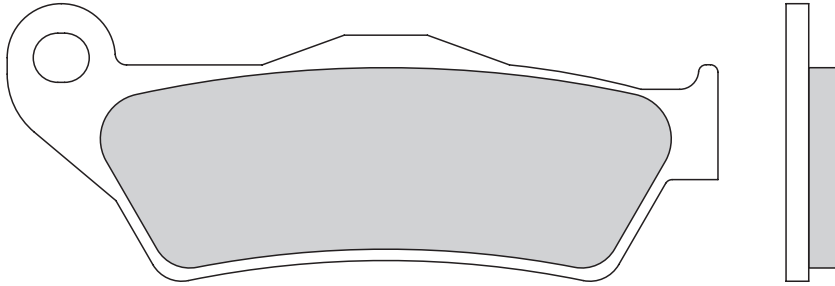

PADS **FD**

DISCS **DF**

GALFER
FD
140
G1054
G1050
G1370

↔ 102,1
mm x
↕ 38,7
↔ 9,8

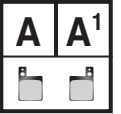
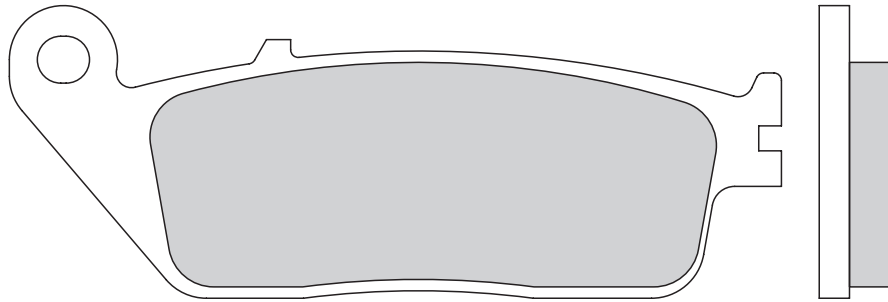

SHOES **MF**

FD266 (th. 8,3mm) can replace FD140 (not vice versa) | FD266 (th. 8,3mm) puede sustituir FD140 (no al revés)

LINES **FK**

GALFER
FD
141
G1054

↔ 58,9
mm x
↕ 43,6
↔ 7,9

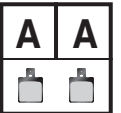
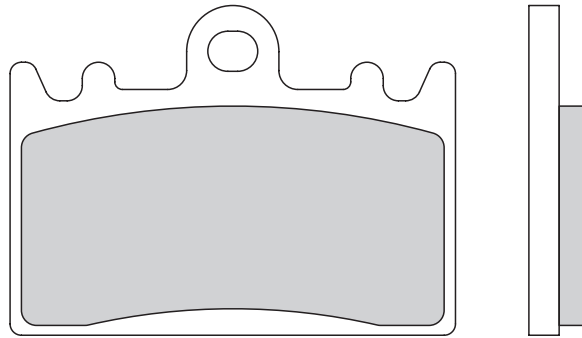

BRACKETS **SP**

KITS **KG**

GALFER
FD
142
G1054
G1050
G1370
G1380

↔ 102,2
mm x
↕ 40,0
↔ 10,0

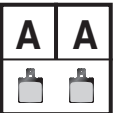
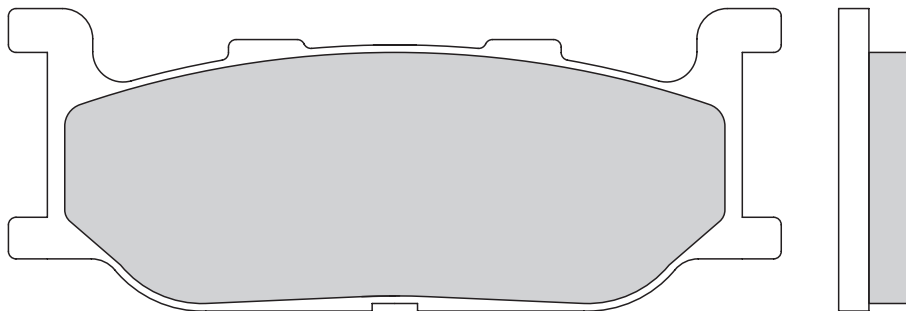

CROSS REFERENCE

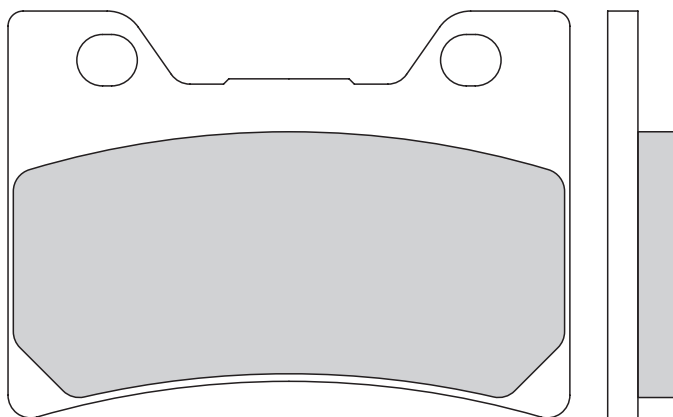
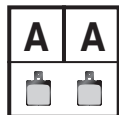

GALFER
FD
143
G1054

74,3
x
53,7
mm
9,2

APPLICATIONS

PADS **FD**

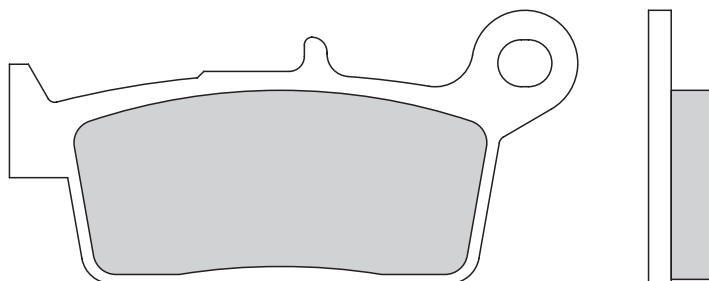
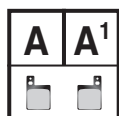

GALFER
FD
144
G1054
G1050

75,2
x
36,1
mm
8,9

DISCS **DF**

SHOES **MF**

FD147 (th. 7,0mm) can replace FD144 (not vice versa) | FD147 (th. 7,0mm) puede sustituir FD144 (no al revés)

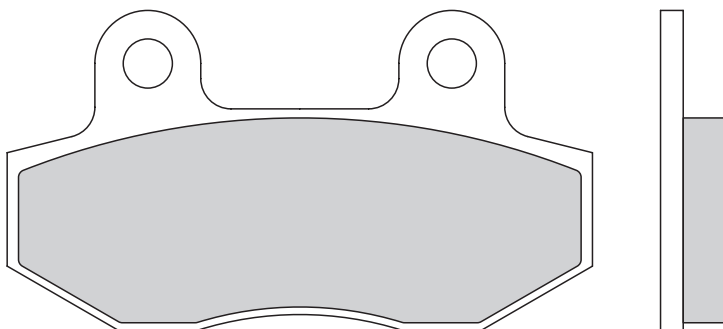
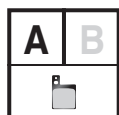

GALFER
FD
145
G1054
G1050
G1380

77,4
x
42,3
mm
9,2

LINES **FK**

BRACKETS **SP**

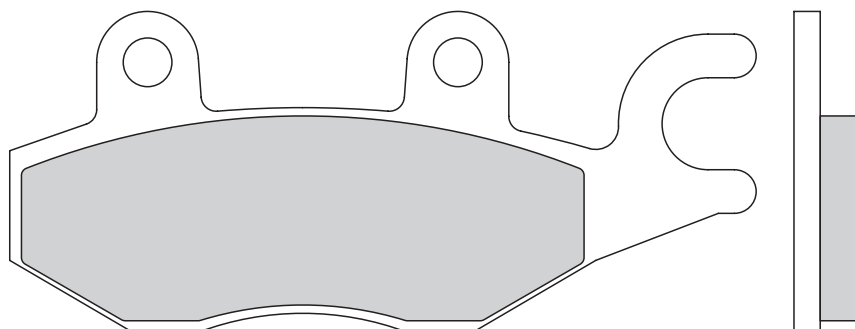
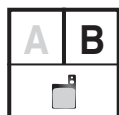

96,8
x
42,3
mm
9,2

KITS **KG**

CROSS REFERENCE

FD117 (th. 7,5mm) can replace FD145 (not vice versa) | FD117 (th. 7,5mm) puede sustituir FD145 (no al revés)



APPLICATIONS

GALFER
FD
147
G1054
G1050

↔ 75,2
mm x
↕ 36,1
↔ 7,0

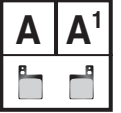
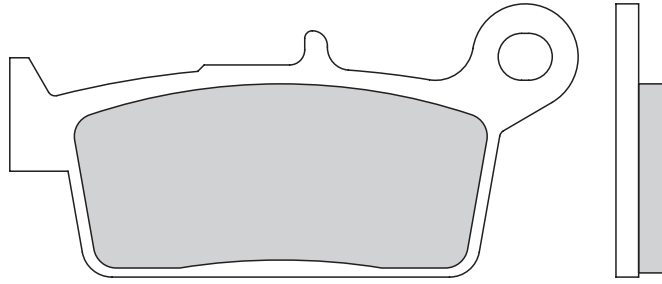

PADS **FD**

DISCS **DF**

GALFER
FD
148
G1054
G1370
G1375

↔ 68,0
mm x
↕ 53,6
↔ 8,5

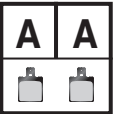
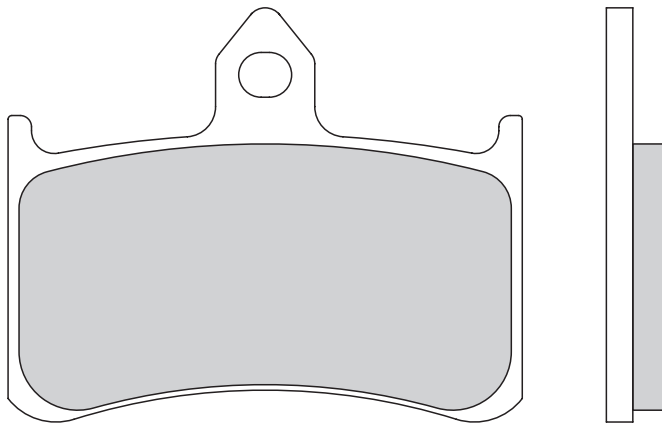

SHOES **MF**

LINES **FK**

GALFER
FD
149
G1054
G1050

↔ 40,9
mm x
↕ 43,0
↔ 7,7

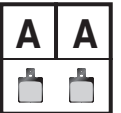
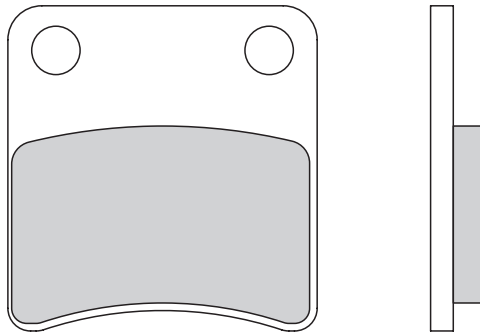

BRACKETS **SP**

KITS **KG**

GALFER
FD
151
G1054
G1050

↔ 55,5
mm x
↕ 46,2
↔ 7,0

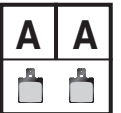
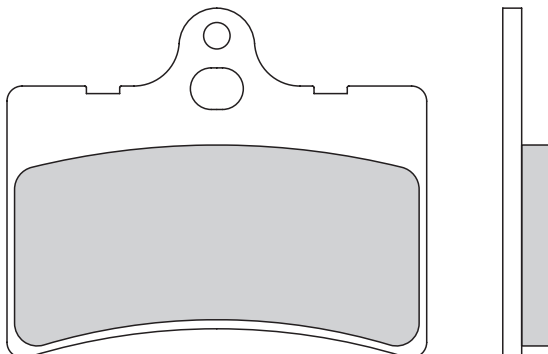

CROSS REFERENCE

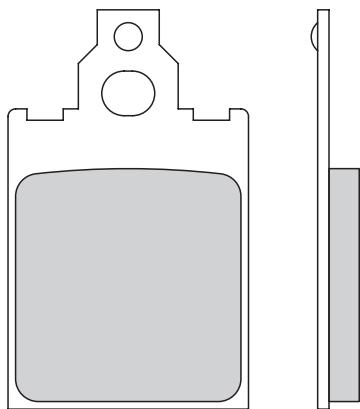
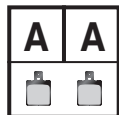

GALFER
FD
152
G1054
G1050

31,8
x
51,2
mm

5,5

APPLICATIONS

PADS **FD**

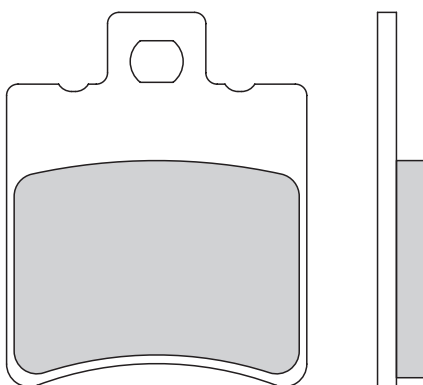
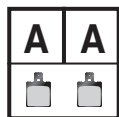

GALFER
FD
153
G1054
G1050
G1380

39,7
x
49,5
mm

6,5

DISCS **DF**

SHOES **MF**

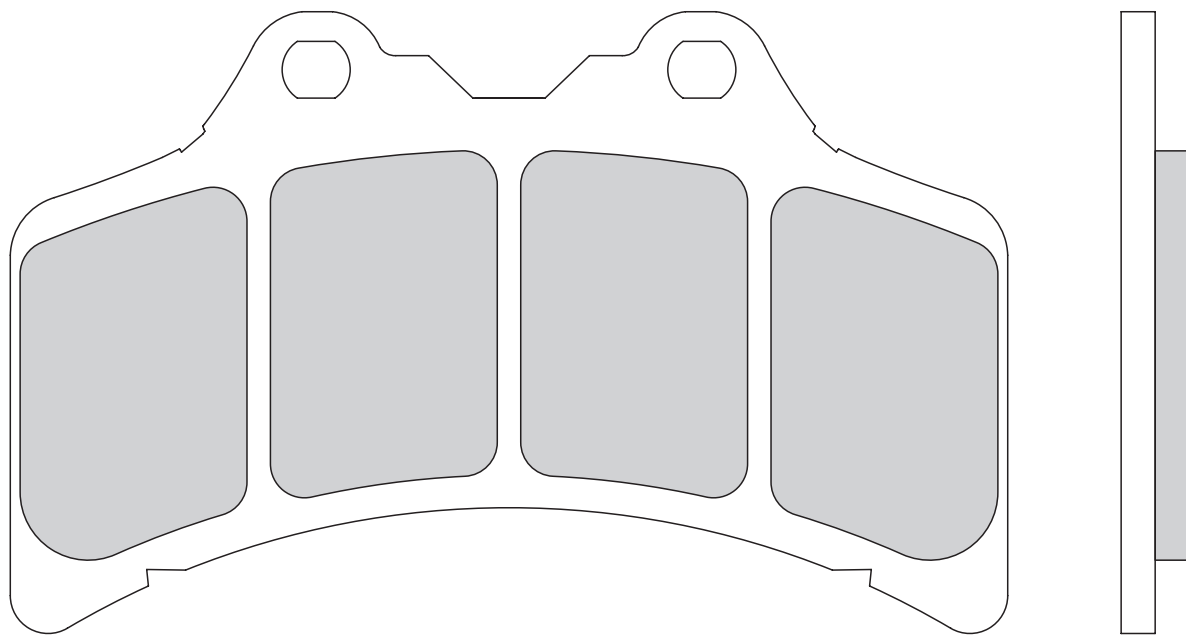
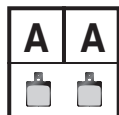

GALFER
FD
154
G1054

131,9
x
82,2
mm

9,5

LINES **FK**

BRACKETS **SP**

KITS **KG**

CROSS REFERENCE



APPLICATIONS

GALFER
FD
155
G1054

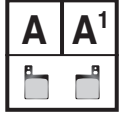
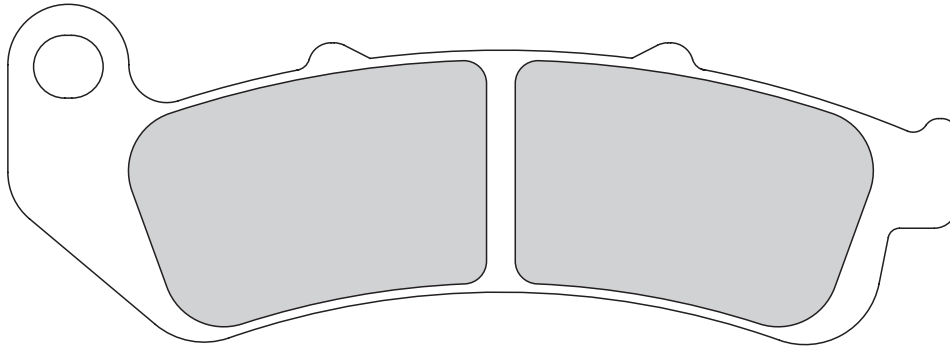

PADS **FD**

125,5
mm x
45,0
8,8

DISCS **DF**

GALFER
FD
156
G1054
G1370
G1375

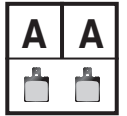
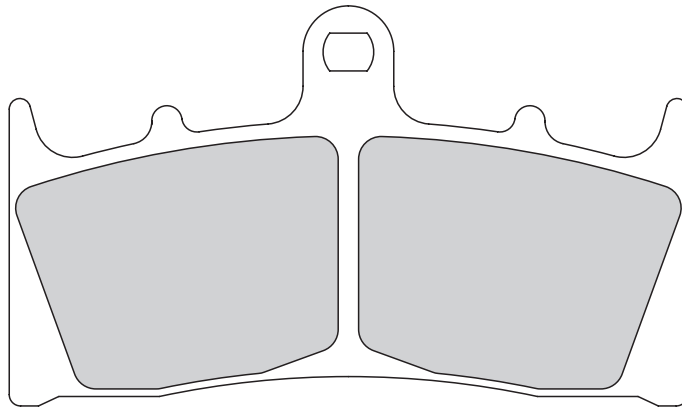

SHOES **MF**

90,0
mm x
55,7
8,0

LINES **FK**

GALFER
FD
157
G1054

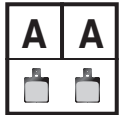
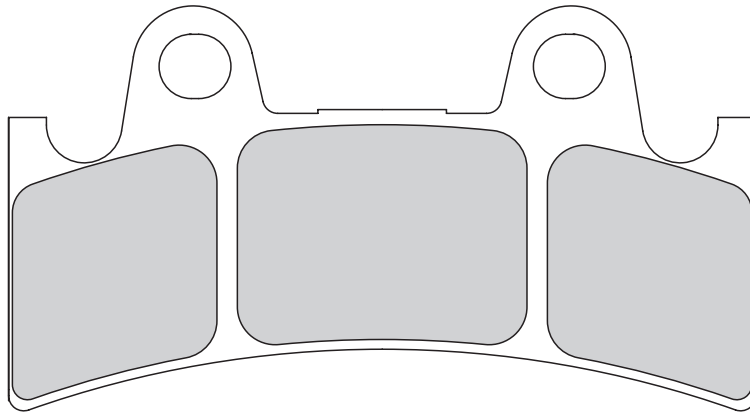

BRACKETS **SP**

98,8
mm x
53,5
10,0

KITS **KG**

GALFER
FD
158
G1054

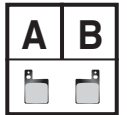
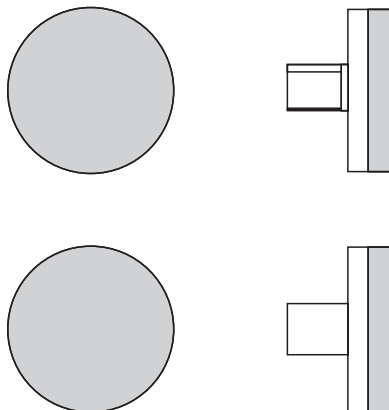

CROSS REFERENCE

22,1
mm x
22,1
5,9

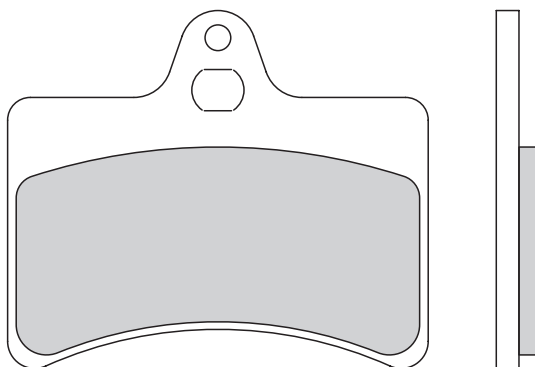
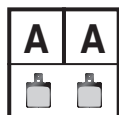

GALFER
FD
159
G1054
G1805

APPLICATIONS

↔ 55,6
mm x
↑↓ 47,3
↔ 6,0

PADS **FD**

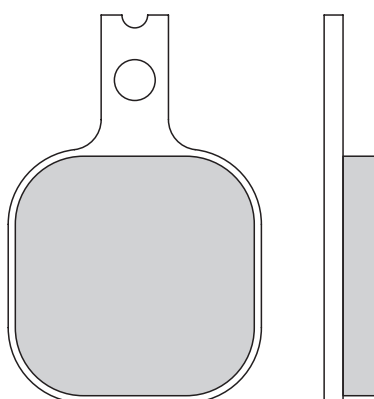
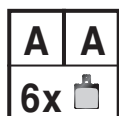

GALFER
FD
160
G1054

DISCS **DF**

↔ 33,5
mm x
↑↓ 51,3
↔ 7,0

SHOES **MF**

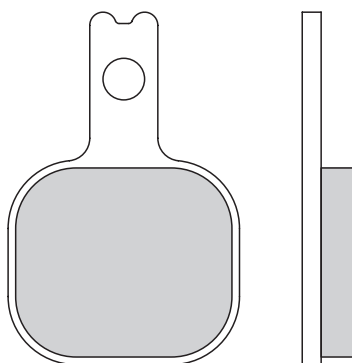
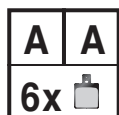

GALFER
FD
161
G1054

LINES **FK**

↔ 30,6
mm x
↑↓ 46,6
↔ 7,0

BRACKETS **SP**

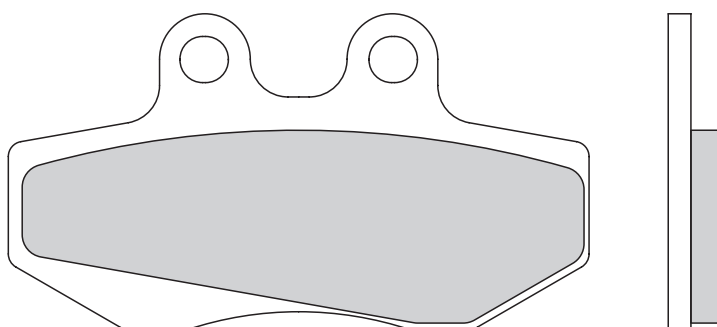
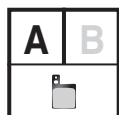

GALFER
FD
162
G1054
G1805
G1380

KITS **KG**

↔ 76,8
mm x
↑↓ 41,8
↔ 7,5

CROSS REFERENCE



APPLICATIONS

	94,5
mm	x
	42,0
	7,5

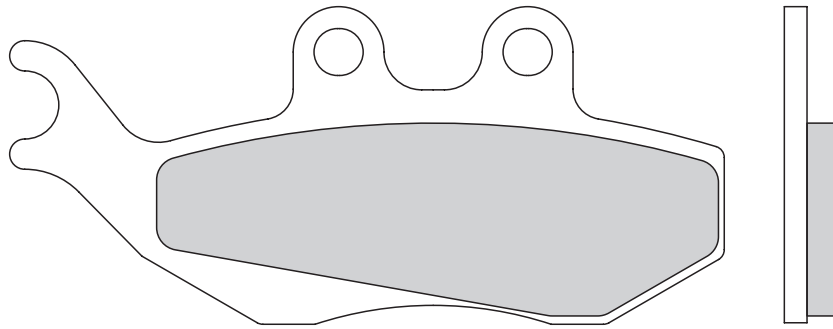
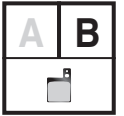

PADS **FD**

DISCS **DF**

GALFER
FD
163
G1054
G1805

	48,0
mm	x
	45,5
	7,1

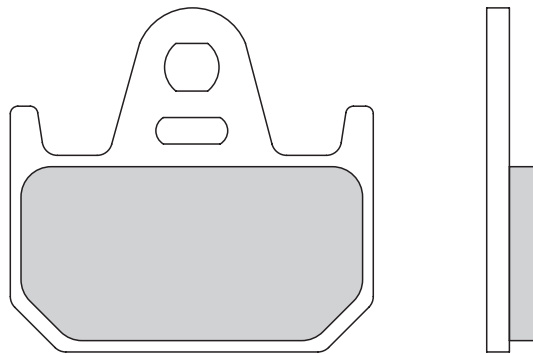
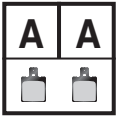

SHOES **MF**

LINES **FK**

GALFER
FD
164
G1054
G1805
G1396
G1396R

	94,2
mm	x
	33,7
	6,8

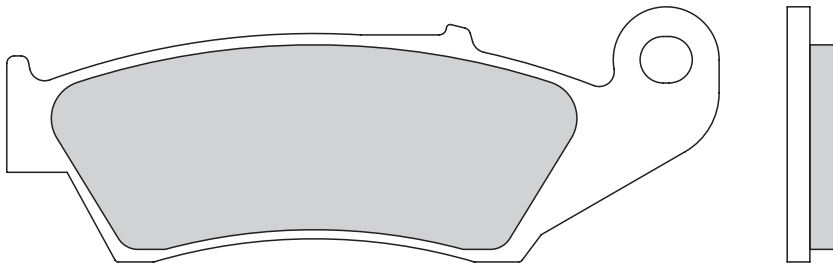
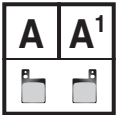

BRACKETS **SP**

KITS **KG**

GALFER
FD
165
G1054
G1805
G1371
G1396

	78,0
mm	x
	40,8
	9,0

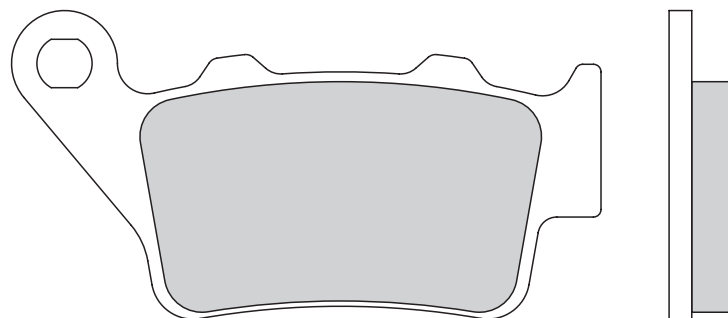
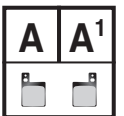

CROSS REFERENCE

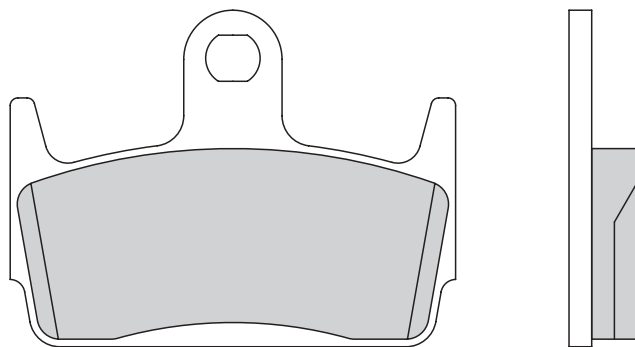
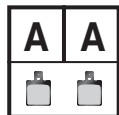

GALFER
FD
166
G1054
G1050

↔ 58,9
mm x
↕ 44,5

⏏ 9,0

APPLICATIONS

PADS **FD**

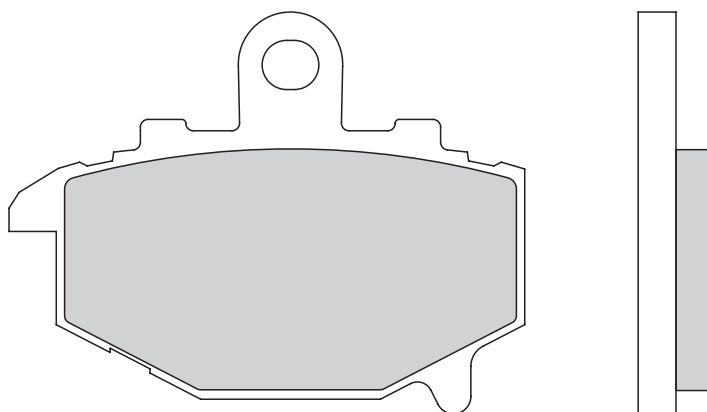
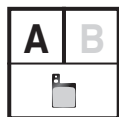

GALFER
FD
167
G1054
G1371

↔ 68,2
mm x
↕ 53,1

⏏ 9,8

DISCS **DF**

SHOES **MF**

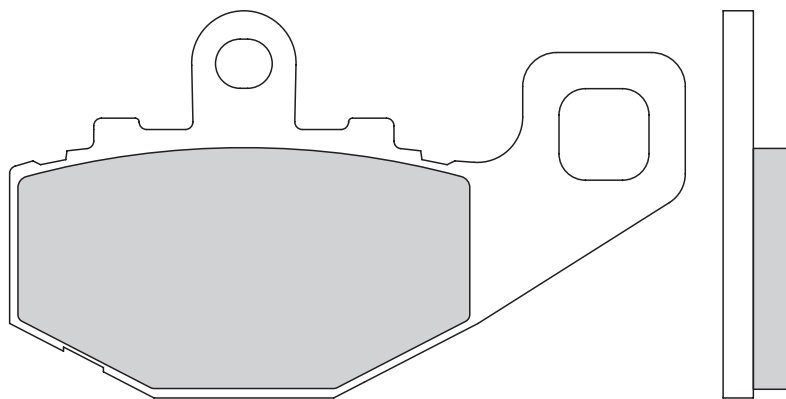
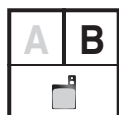

↔ 89,4
mm x
↕ 51,2

⏏ 8,8

LINES **FK**

BRACKETS **SP**

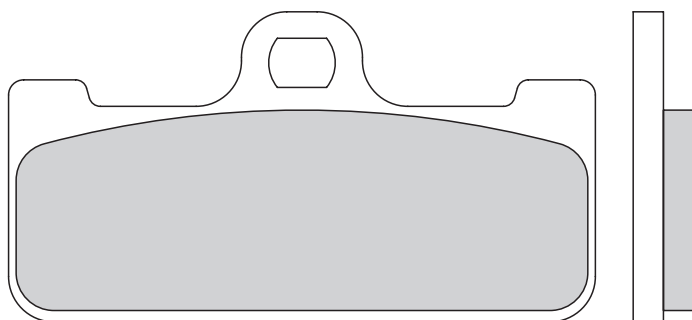
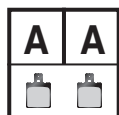

GALFER
FD
168
G1054
G1375
G1375R

↔ 77,4
mm x
↕ 42,8

⏏ 8,4

KITS **KG**

CROSS REFERENCE



APPLICATIONS

GALFER
FD
169
G1054
G1050
G1370
G1375
G1380

↔ 94,2
mm x
↑↓ 41,0
↔ 10,0

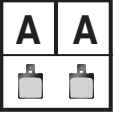
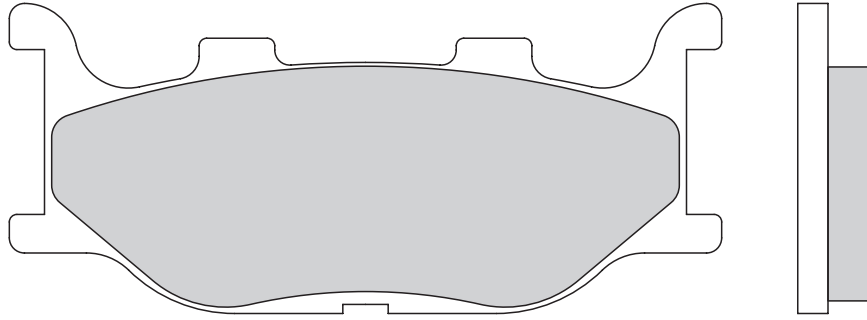

PADS **FD**

DISCS **DF**

GALFER
FD
170
G1054
G1050
G1805

↔ 39,8
mm x
↑↓ 56,3
↔ 7,3

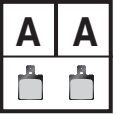
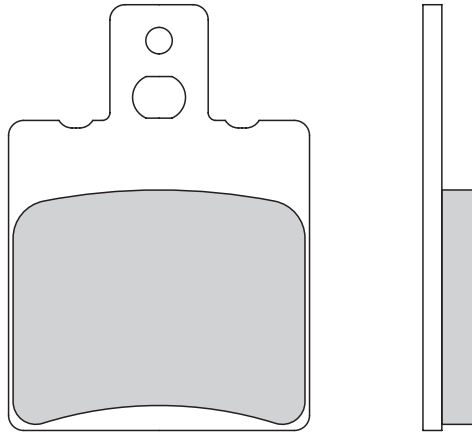

SHOES **MF**

FD012 (th. 7,0mm) can replace **FD170** (not vice versa) | **FD012** (th. 7,0mm) puede sustituir **FD170** (no al revés)

LINES **FK**

GALFER
FD
171
G1054
G1050

↔ 39,8
mm x
↑↓ 54,0
↔ 6,4

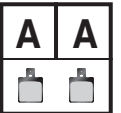
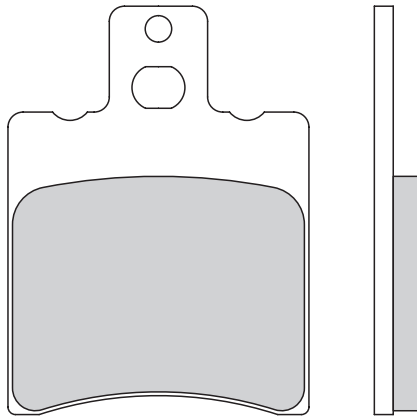

BRACKETS **SP**

KITS **KG**

GALFER
FD
172
G1054
G1370

↔ 108,7
mm x
↑↓ 39,8
↔ 7,5

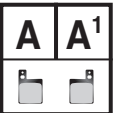
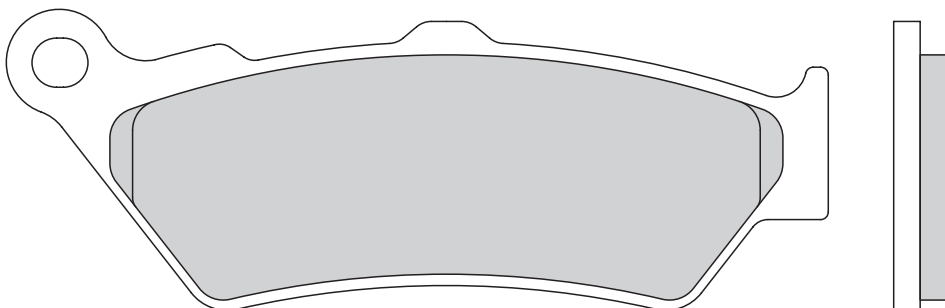

CROSS REFERENCE

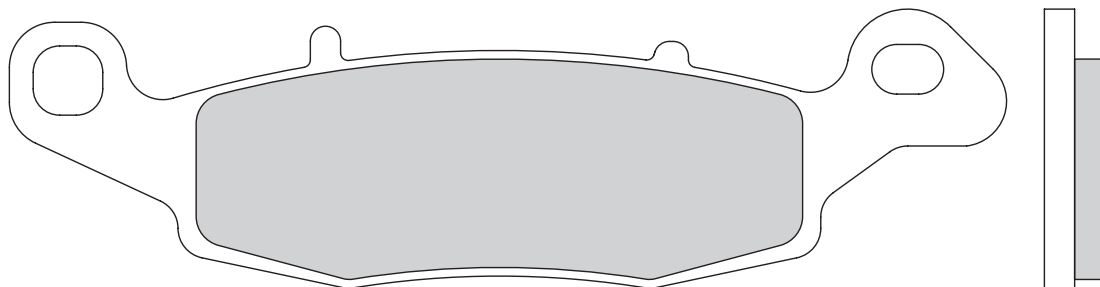
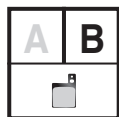
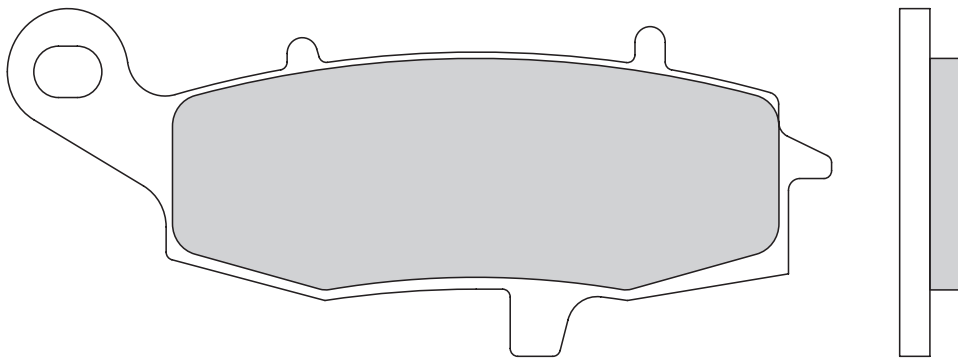
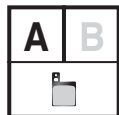

GALFER
FD
174
G1054
G1370
G1375

109,0
mm x
44,0

8,5

131,9
mm x
37,2

8,4

APPLICATIONS

PADS **FD**

DISCS **DF**

SHOES **MF**

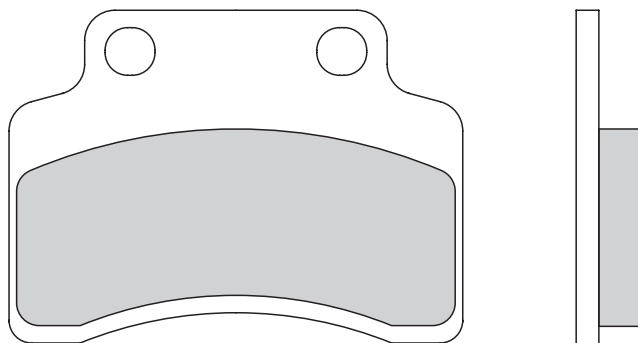
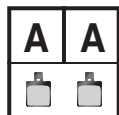

GALFER
FD
175
G1054
G1050

60,0
mm x
44,0

9,0

LINES **FK**

BRACKETS **SP**

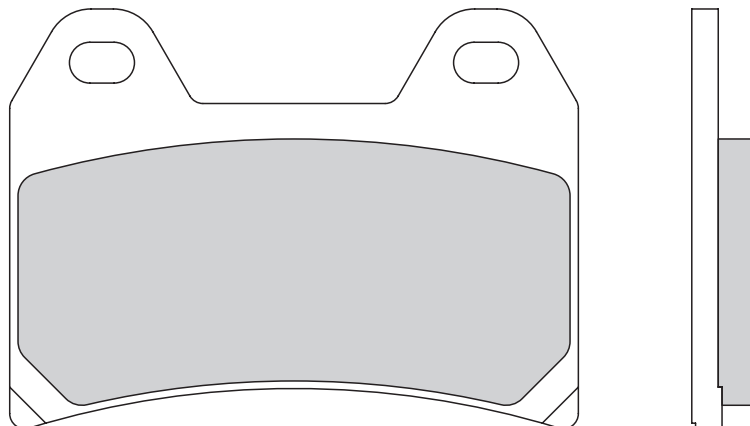
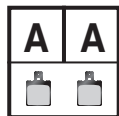

GALFER
FD
176
G1054
G1370
G1375
G1375R

75,0
mm x
55,5

8,5

KITS **KG**

CROSS REFERENCE



APPLICATIONS

GALFER
FD
177
G1054
G1050

↔ 76,5
mm x
↕ 41,3

↔ 8,2

↔ 99,0
mm x
↕ 39,8

↔ 7,5

PADS **FD**

DISCS **DF**

SHOES **MF**

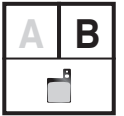
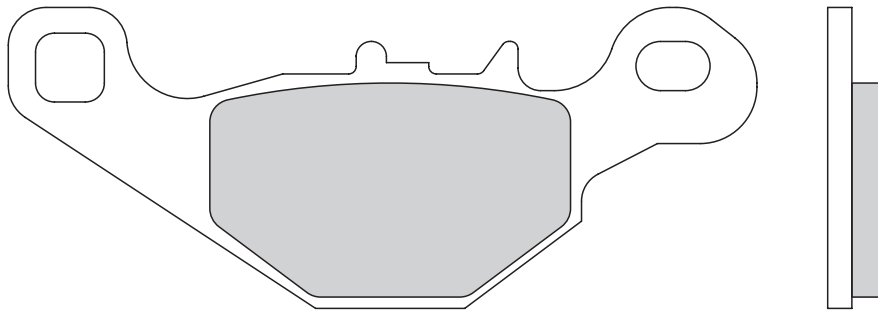
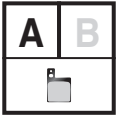
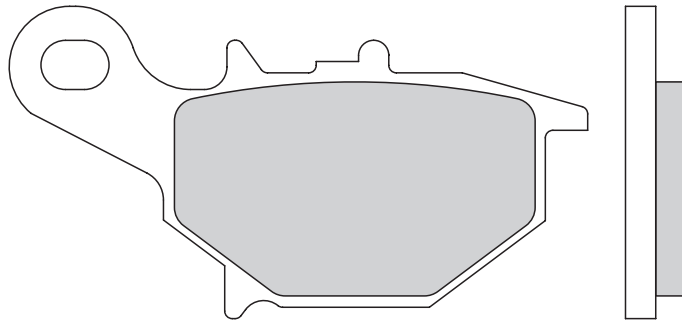

LINES **FK**

GALFER
FD
178
G1054
G1370
G1380
G1375
G1375R

↔ 69,0
mm x
↕ 50,6

↔ 8,8

BRACKETS **SP**

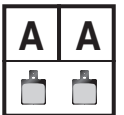
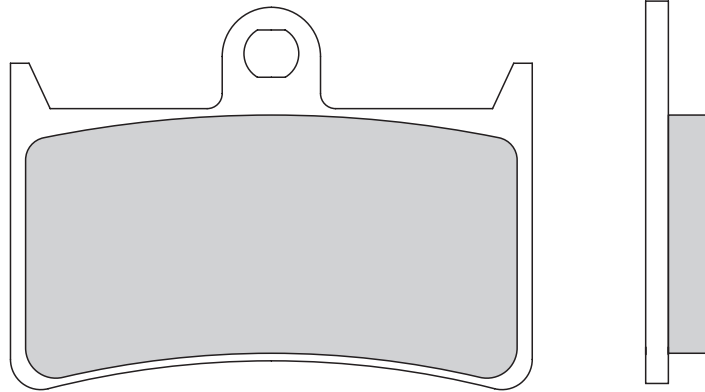

FD068 (th. 8,2mm) replace FD178 (not vice versa) | FD068 (th. 8,2mm) sustituye a FD178 (no al revés)



KITS **KG**

GALFER
FD
179
G1054
G1370
G1375

↔ 109,0
mm x
↕ 44,0

↔ 8,4

CROSS REFERENCE

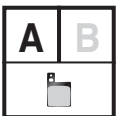
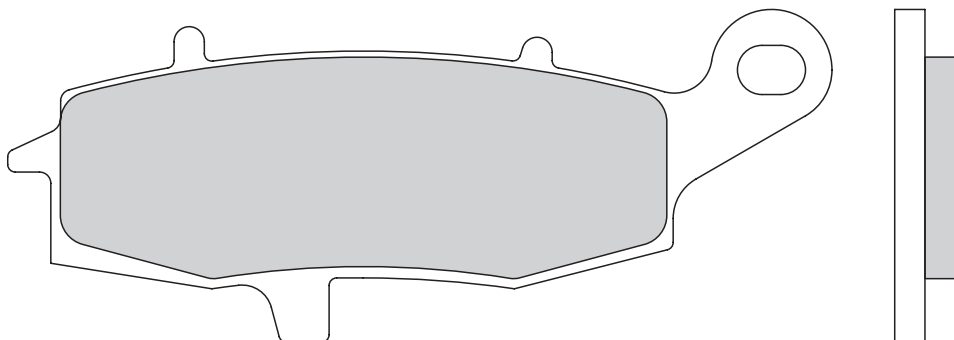

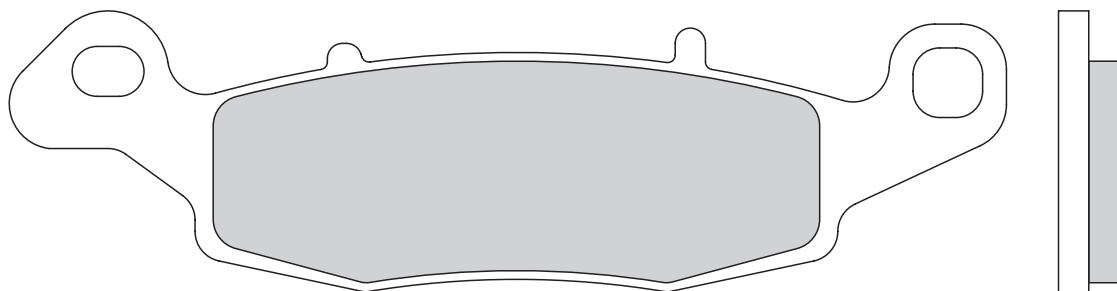
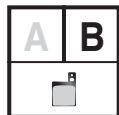

↔	131,9
mm	x
↑	37,2
↔	8,4

APPLICATIONS

PADS **FD**

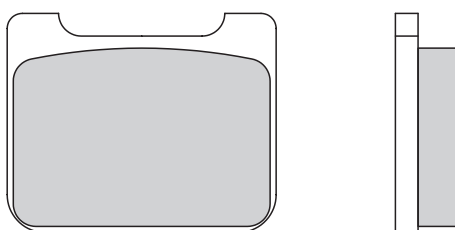
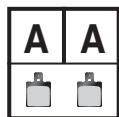

GALFER
FD
181
G1054

↔	35,6
mm	x
↑	29,0
↔	8,3

DISCS **DF**

SHOES **MF**

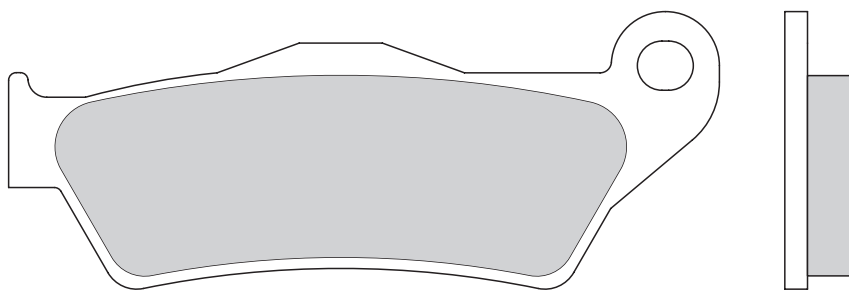
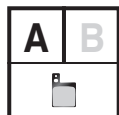

GALFER
FD
186
G1054
G1371

↔	94,0
mm	x
↑	36,7
↔	10,1

LINES **FK**

BRACKETS **SP**

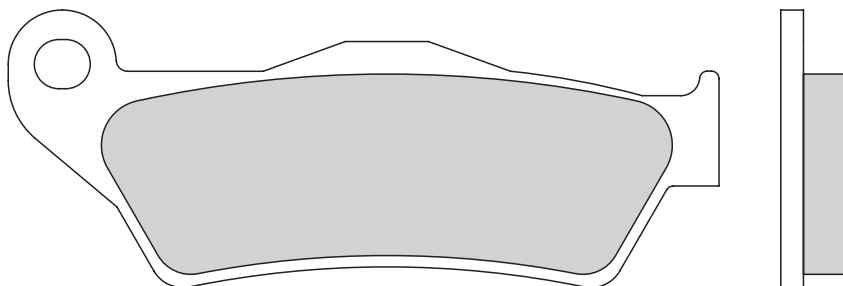
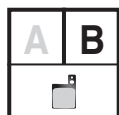

↔	94,0
mm	x
↑	36,7
↔	8,5

KITS **KG**

CROSS REFERENCE

FD138 (th. 7,6mm) can replace FD186 (not vice versa) | FD138 (th. 7,6mm) puede sustituir FD186 (no al revés)



APPLICATIONS

GALFER
FD
187
G1054
G1050
G1805
G1380

PADS **FD**

↔ 77,4
mm x
↕ 42,3

↔ 8,5

DISCS **DF**

↔ 98,8
mm x
↕ 42,3

↔ 8,5

SHOES **MF**

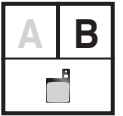
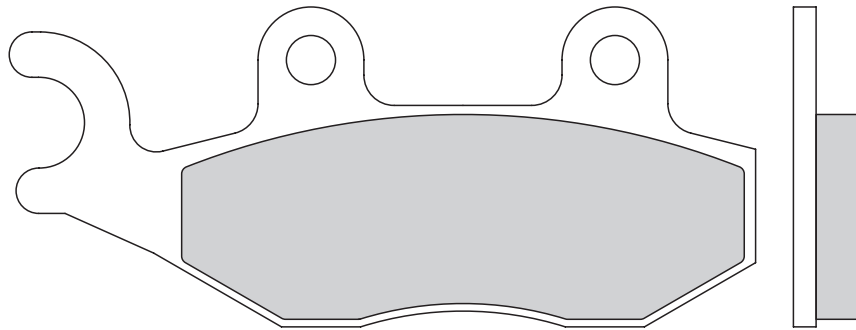
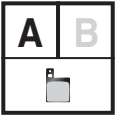
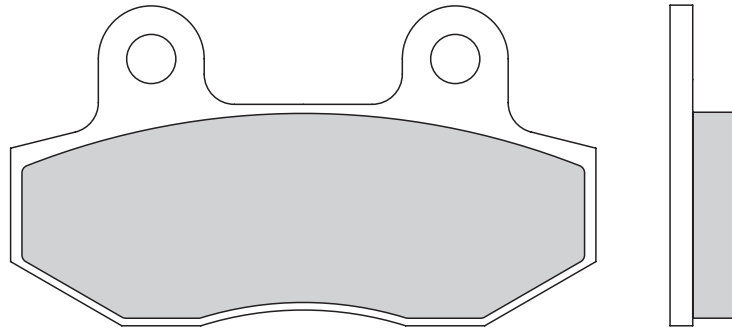

FD086 (th. 7,5mm) can replace FD187 (not vice versa) | FD086 (th. 7,5mm) puede sustituir FD187 (no al revés)

LINES **FK**

GALFER
FD
188
G1054
G1050
G1380

BRACKETS **SP**

↔ 70,2
mm x
↕ 41,1

↔ 8,0

KITS **KG**

↔ 85,1
mm x
↕ 44,3

↔ 8,0

CROSS REFERENCE

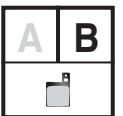
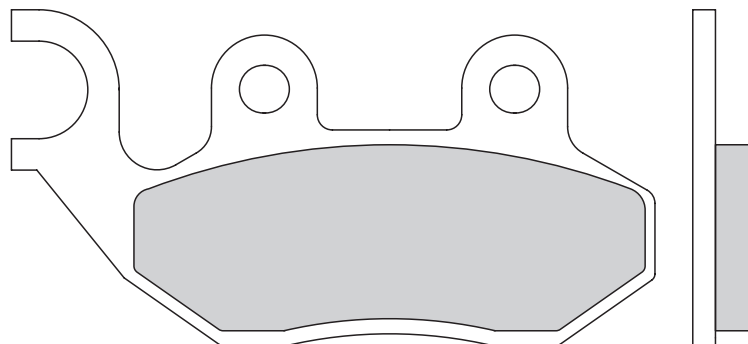
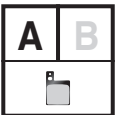
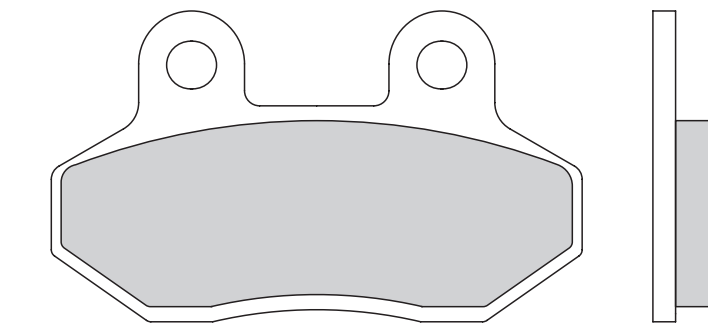

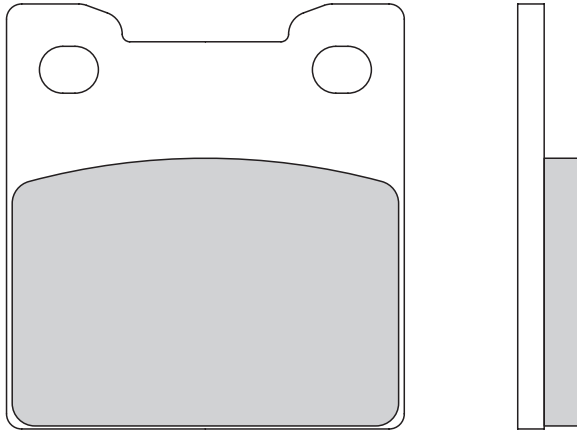
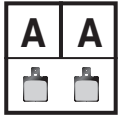

GALFER
FD
189
G1054

52,6
mm x
56,2

8,6

APPLICATIONS

PADS **FD**

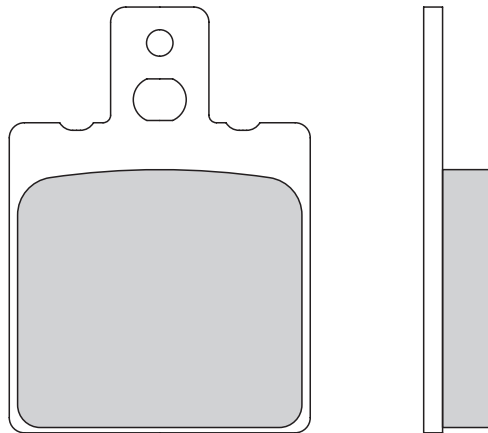
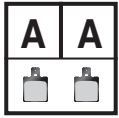

GALFER
FD
190
G1054

39,8
mm x
56,3

9,3

DISCS **DF**

SHOES **MF**

FD012 (th. 7,0mm) can replace FD190 (not vice versa) | FD012 (th. 7,0mm) puede sustituir FD190 (no al revés)

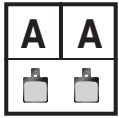

GALFER
FD
193
G1054
G1375

92,0
mm x
51,5

9,5

LINES **FK**

BRACKETS **SP**

FD384 (th. 8,0mm) can replace FD193 (not vice versa) | FD384 (th. 8,0mm) puede sustituir FD193 (no al revés)

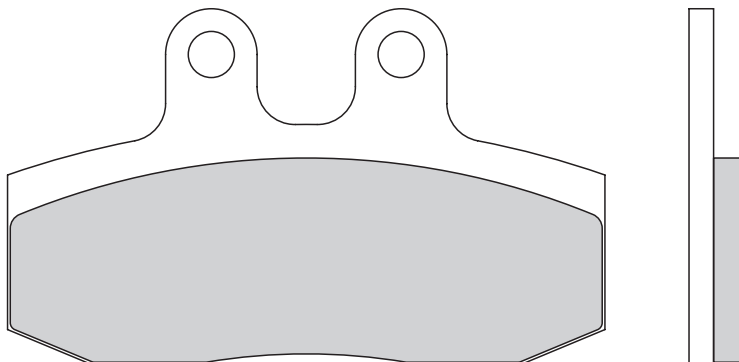
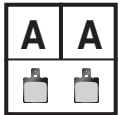

GALFER
FD
195
G1054
G1050

79,0
mm x
47,1

7,5

KITS **KG**

CROSS REFERENCE



APPLICATIONS

GALFER
FD
197
G1054
G1050

↔ 31,5
mm x
↕ 49,0
↔ 7,0

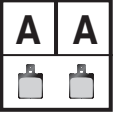
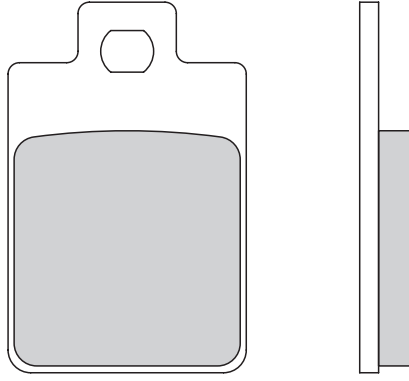

PADS **FD**

DISCS **DF**

GALFER
FD
198
G1054
G1370

↔ 100,0
mm x
↕ 56,0
↔ 8,5

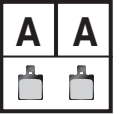
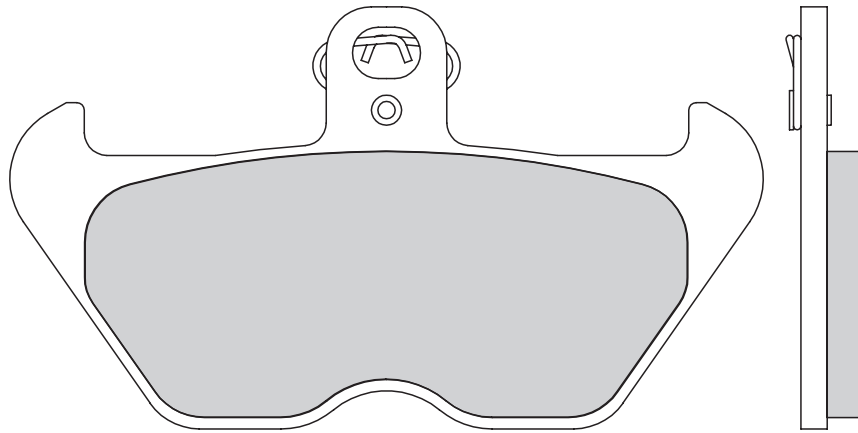

SHOES **MF**

LINES **FK**

GALFER
FD
200
G1054
G1050
G1380

↔ 35,6
mm x
↕ 49,0
↔ 7,0

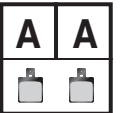
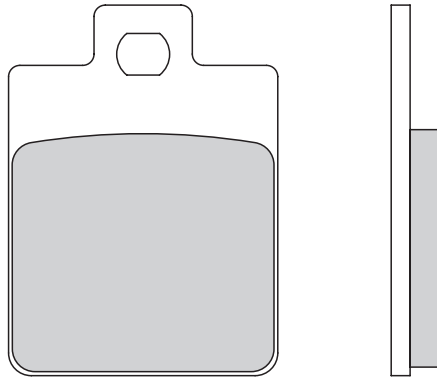

BRACKETS **SP**

KITS **KG**

GALFER
FD
204
G1054
G1396

↔ 94,1
mm x
↕ 35,7
↔ 7,4

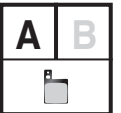
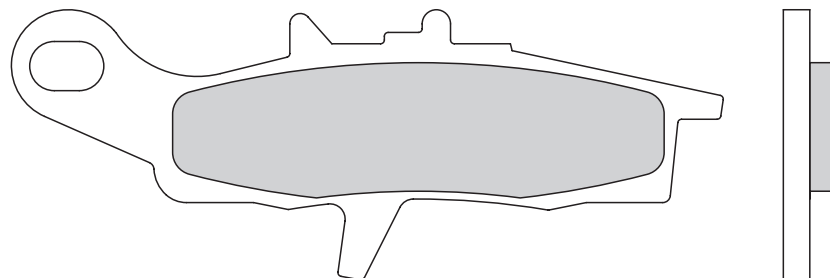

CROSS REFERENCE

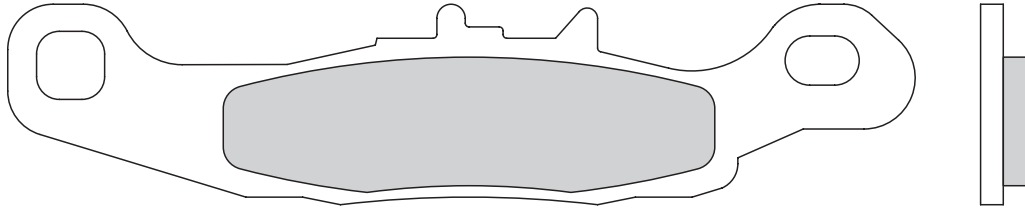
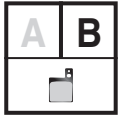

↔	120,0
mm	x
↕	26,5
↔	7,0

APPLICATIONS

PADS **FD**

DISCS **DF**

SHOES **MF**

LINES **FK**

BRACKETS **SP**

KITS **KG**

CROSS REFERENCE

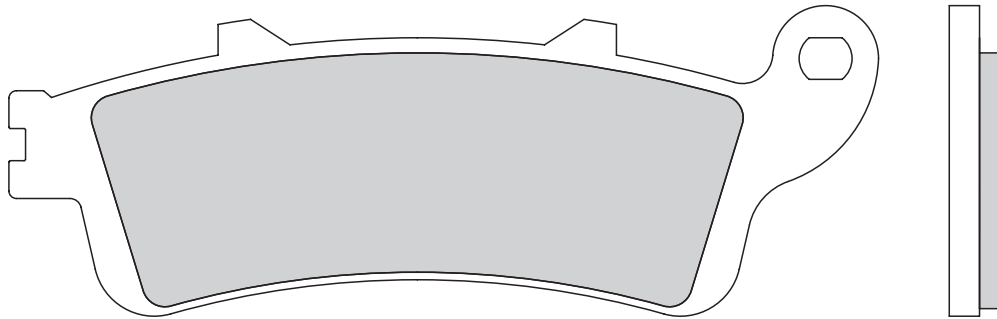
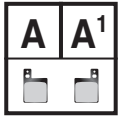

GALFER
FD
205
G1054
G1375
G1380

↔	115,0
mm	x
↕	41,1
↔	7,5

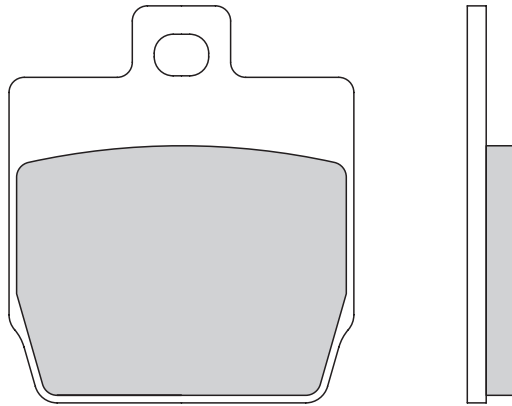
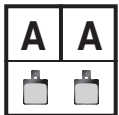

GALFER
FD
206
G1054
G1050
G1380

↔	45,6
mm	x
↕	52,5
↔	7,0

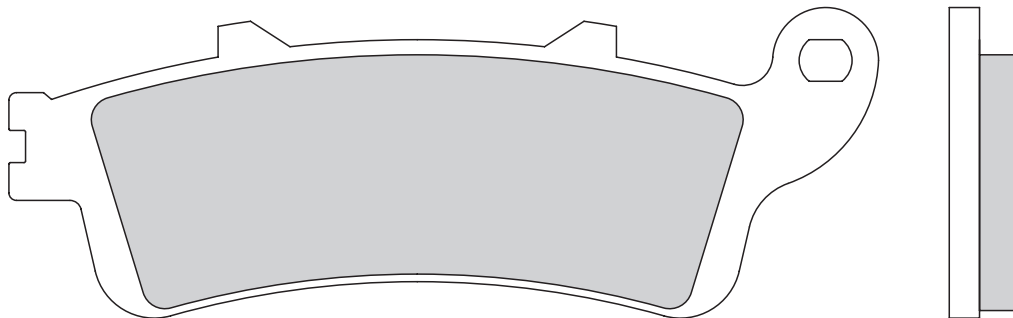
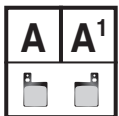

GALFER
FD
207
G1054
G1050
G1370
G1380

↔	115,0
mm	x
↕	41,1
↔	9,4

FD205 (th. 7,5mm) can replace FD207 (not vice versa) | FD205 (th. 7,5mm) puede sustituir FD207 (no al revés)



APPLICATIONS

GALFER
FD
209
G1054
G1050

PADS **FD**

↔ 77,0
mm x
↕ 54,0
↔ 7,0

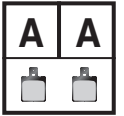
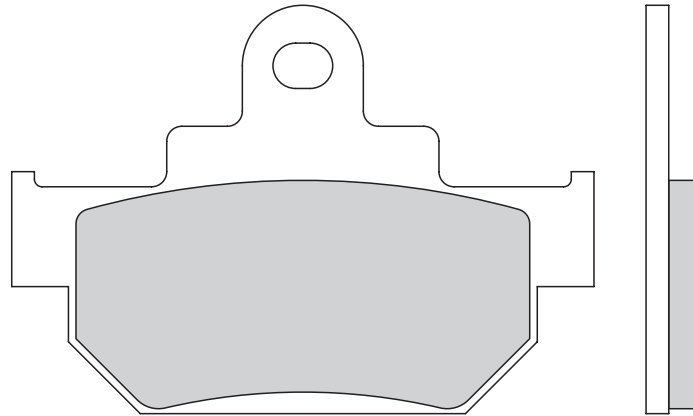

DISCS **DF**

GALFER
FD
210
G1054
G1805

SHOES **MF**

↔ 55,0
mm x
↕ 42,2
↔ 6,3

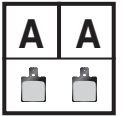
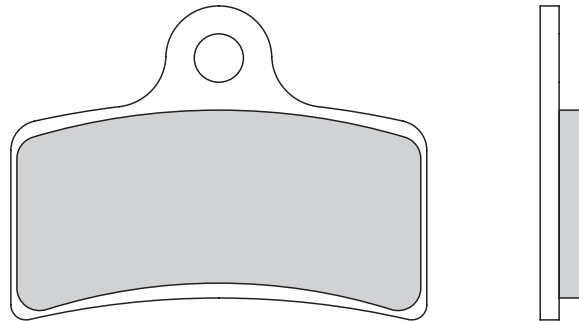

LINES **FK**

GALFER
FD
214
G1054
G1050
G1371
G1380

BRACKETS **SP**

↔ 99,8
mm x
↕ 31,0
↔ 9,0

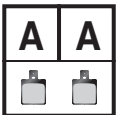
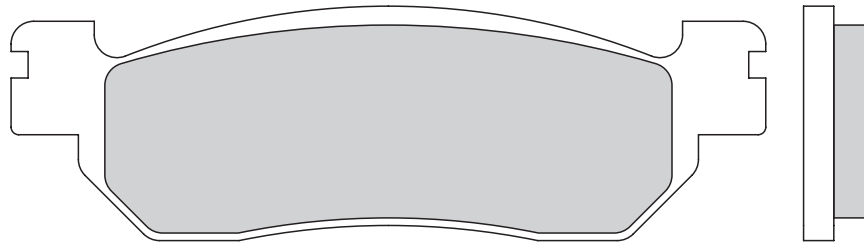

KITS **KG**

GALFER
FD
218
G1054

CROSS REFERENCE

↔ 51,9
mm x
↕ 59,8
↔ 8,8

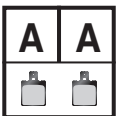
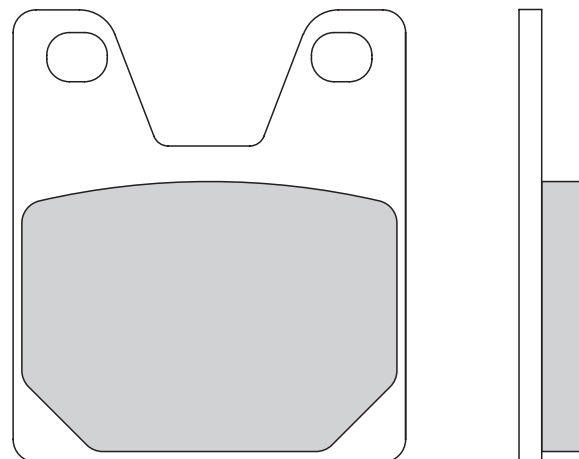

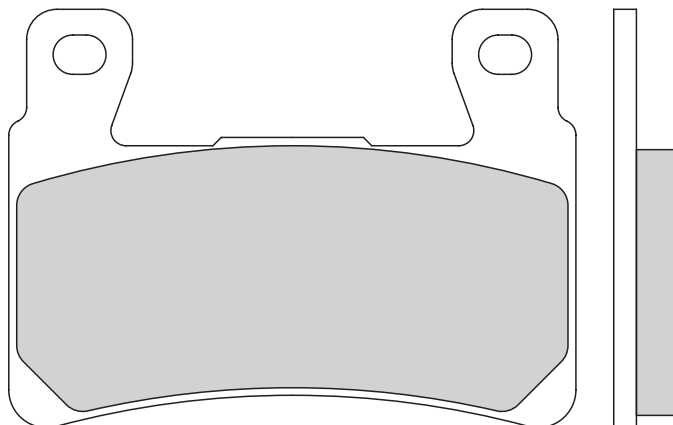
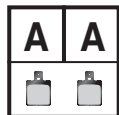

GALFER
FD
219
G1054
G1370
G1375

75,0
x
55,3
mm
8,3

APPLICATIONS

PADS **FD**

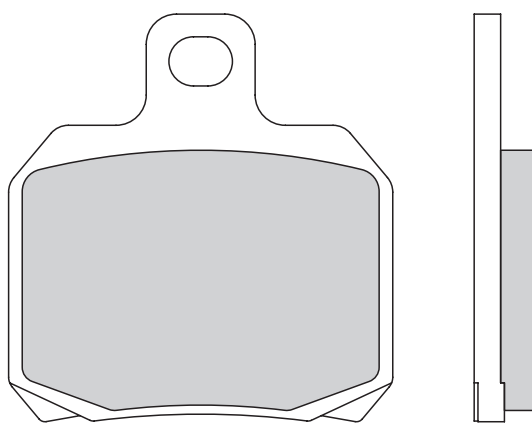
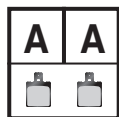

GALFER
FD
220
G1054
G1050
G1371
G1380

50,8
x
53,9
mm
8,0

DISCS **DF**

SHOES **MF**

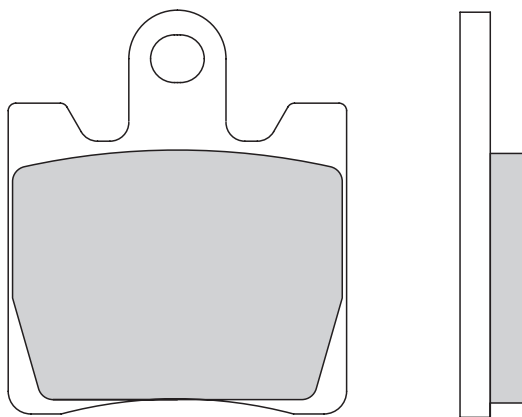
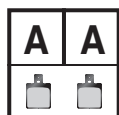

GALFER
FD
222
G1054
G1050
G1380

44,8
x
53,4
mm
8,6

LINES **FK**

BRACKETS **SP**

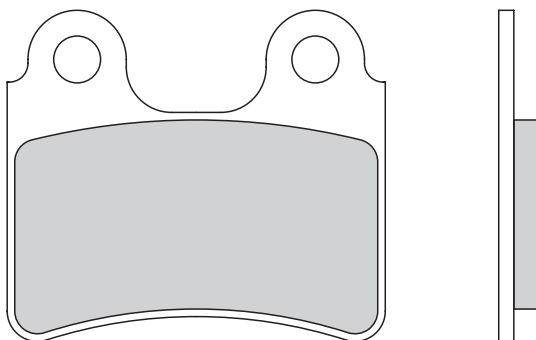
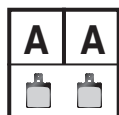

GALFER
FD
223
G1054
G1805

50,0
x
43,8
mm
6,0

KITS **KG**

CROSS REFERENCE



APPLICATIONS

GALFER
FD
224
G1054
G1050
G1805

↔ 36,0
mm x
↕ 39,0
↔ 6,0

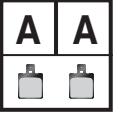
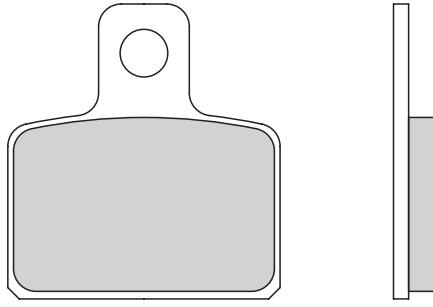

PADS **FD**

DISCS **DF**

GALFER
FD
225
G1054
G1050
G1805

↔ 56,8
mm x
↕ 44,3
↔ 6,5

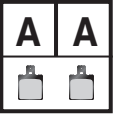
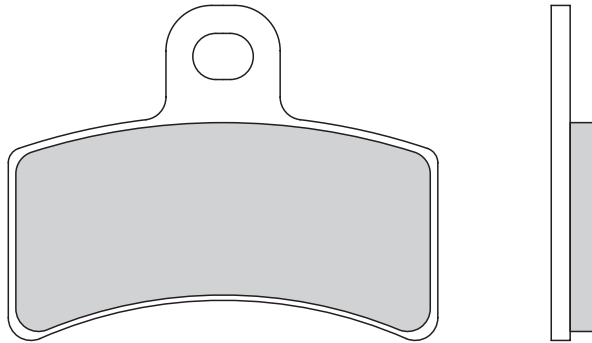

SHOES **MF**

LINES **FK**

GALFER
FD
226
G1054

↔ 68,0
mm x
↕ 41,0
↔ 8,5

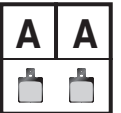
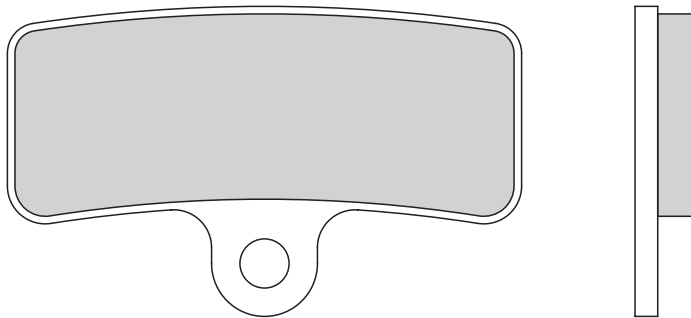

BRACKETS **SP**

KITS **KG**

GALFER
FD
228
G1054
G1050
G1380

↔ 50,9
mm x
↕ 53,5
↔ 9,3

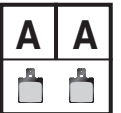
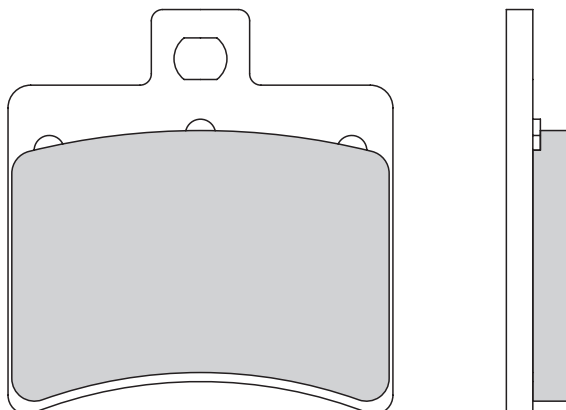

CROSS REFERENCE

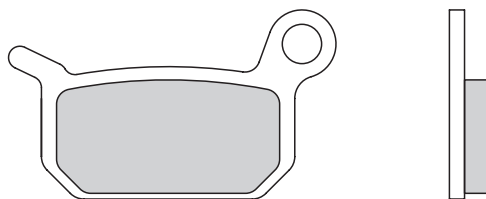
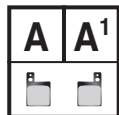

GALFER
FD
230
G1054
G1396

APPLICATIONS

43,3
mm x
25,9

5,1

PADS **FD**

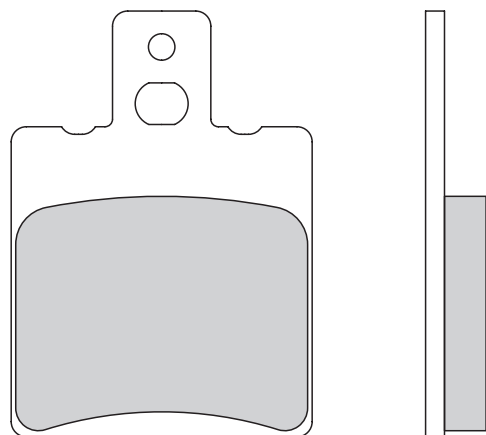
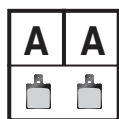

GALFER
FD
232
G1054
G1050

DISCS **DF**

39,8
mm x
56,3

8,0

SHOES **MF**

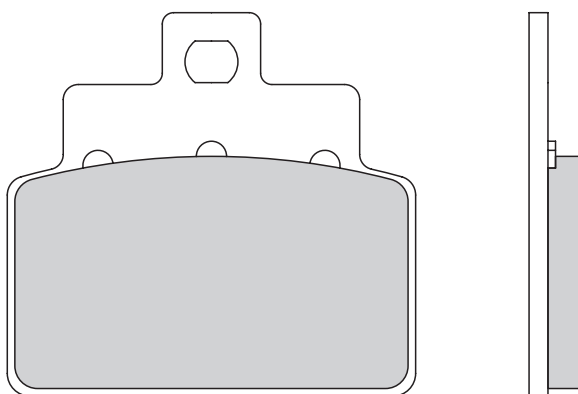
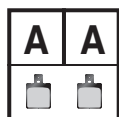

GALFER
FD
234
G1054
G1050

LINES **FK**

54,0
mm x
50,7

7,0

BRACKETS **SP**

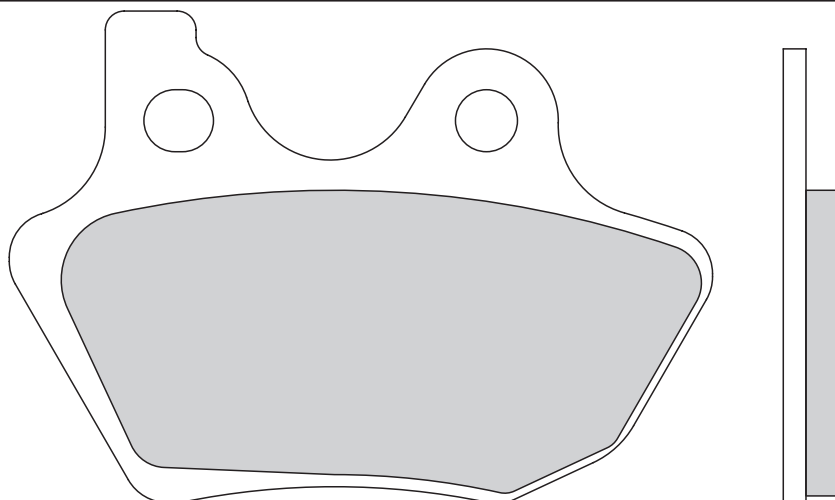
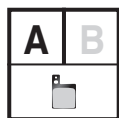

GALFER
FD
235
G1054
G1370
G1375

KITS **KG**

93,0
mm x
65,0

7,5

CROSS REFERENCE



APPLICATIONS

	93,0
mm	x
	65,0
	7,5

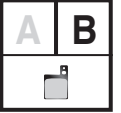
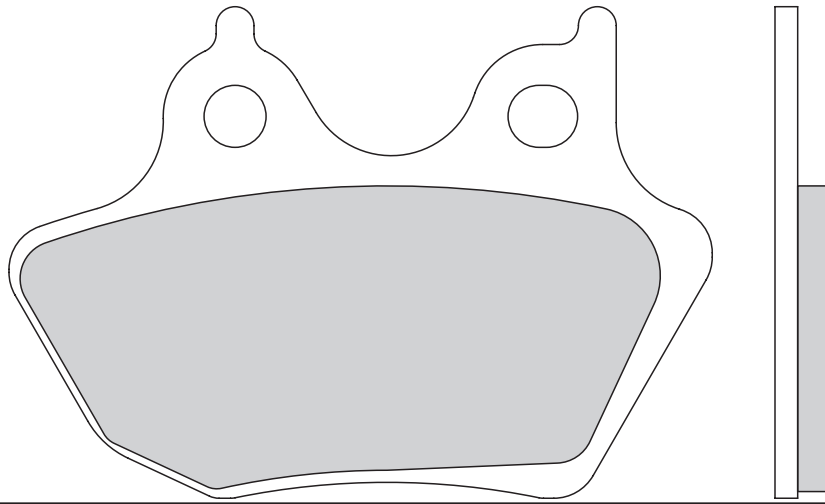

PADS **FD**

DISCS **DF**

GALFER	
FD	
238	
G1054	
G1805	

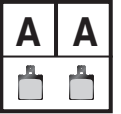
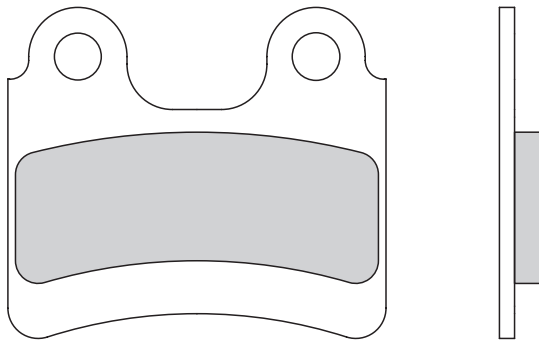

SHOES **MF**

	50,0
mm	x
	43,8
	6,0

LINES **FK**

GALFER	
FD	
239	
G1054	
G1805	

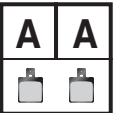
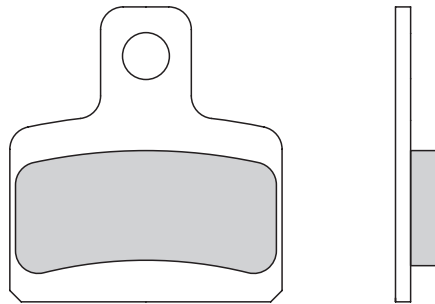

BRACKETS **SP**

	36,0
mm	x
	39,0
	6,0

KITS **KG**

GALFER	
FD	
245	
G1054	
G1050	
G1380	

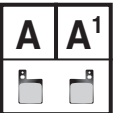
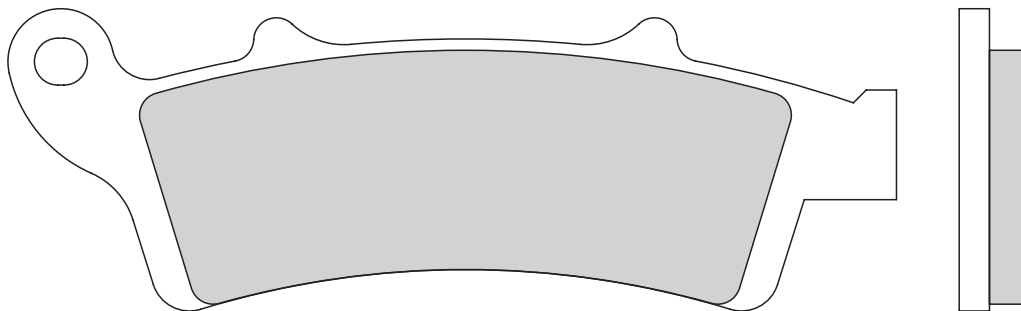

CROSS REFERENCE

	117,5
mm	x
	40,0
	8,4

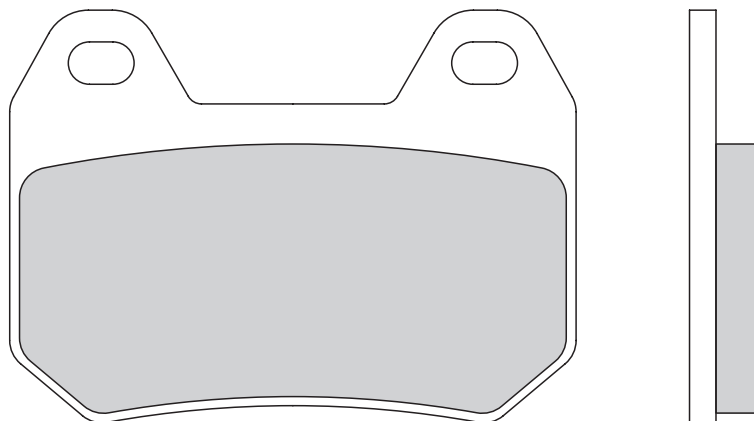
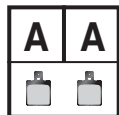

GALFER
FD
251
G1054

↔ 74,9
mm x
↕ 54,6

⊥ 9,0

APPLICATIONS

PADS **FD**

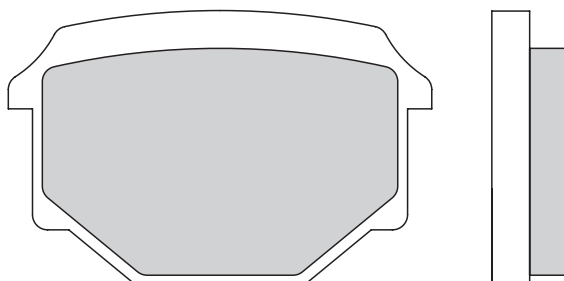
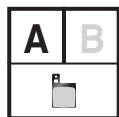

GALFER
FD
252
G1054
G1050

↔ 56,0
mm x
↕ 36,0

⊥ 10,2

DISCS **DF**

SHOES **MF**

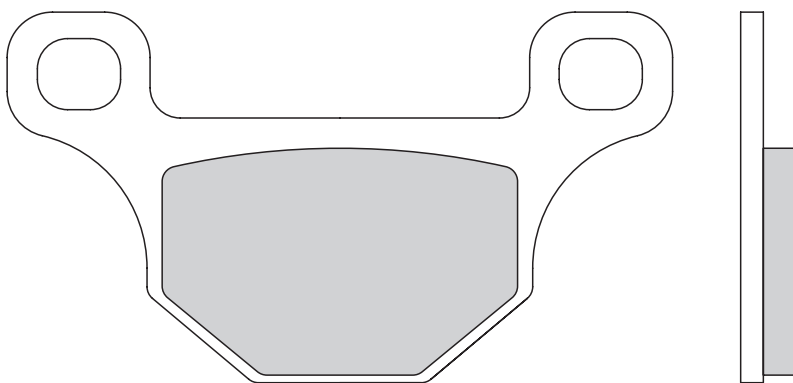
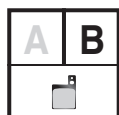

↔ 88,0
mm x
↕ 49,0

⊥ 7,6

LINES **FK**

BRACKETS **SP**

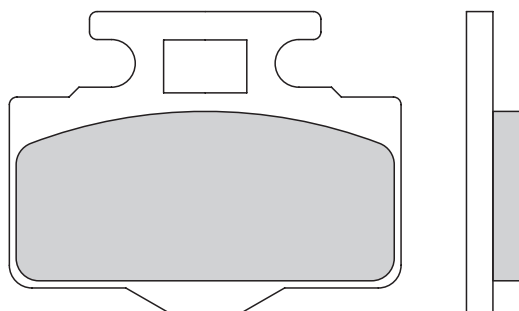
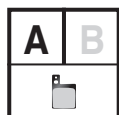

GALFER
FD
254
G1054
G1396

↔ 51,8
mm x
↕ 40,0

⊥ 7,6

KITS **KG**

CROSS REFERENCE



APPLICATIONS

	67,7
mm	x
	36,5
	7,6

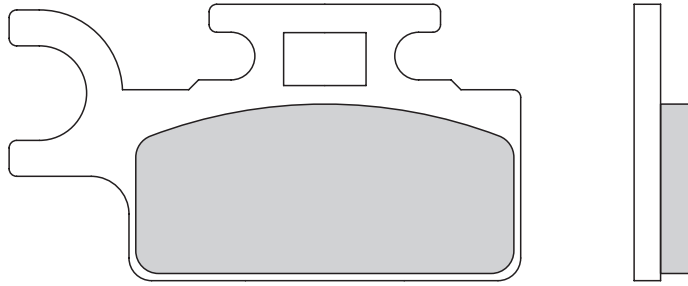
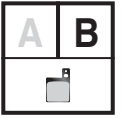

PADS **FD**

DISCS **DF**

GALFER
FD
259
G1054
G1050

	91,5
mm	x
	40,0
	10,0

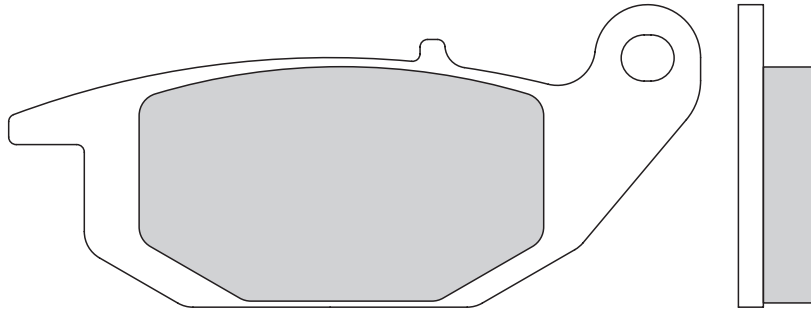
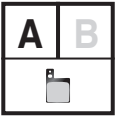

SHOES **MF**

	107,0
mm	x
	42,5
	10,0

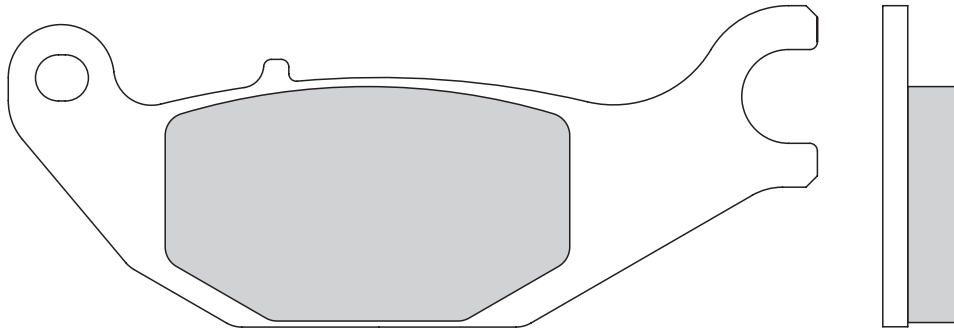
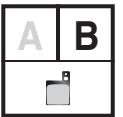

LINES **FK**

BRACKETS **SP**

KITS **KG**

GALFER
FD
260
G1054
G1050
G1380

	100,0
mm	x
	38,4
	11,8

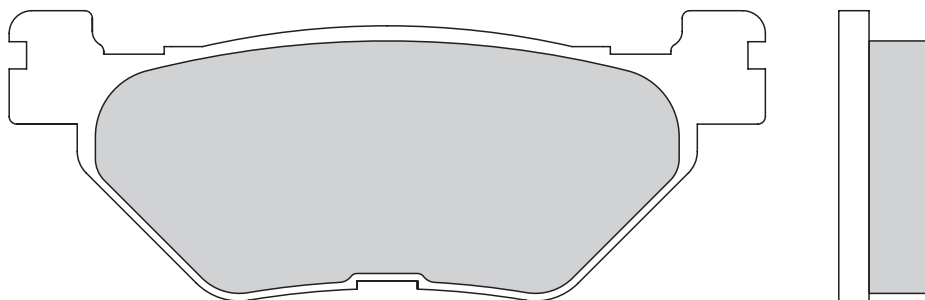
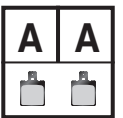

CROSS REFERENCE

FD295 (th. 9,5mm) can replace FD260 (not vice versa) | FD295 (th. 9,5mm) puede sustituir FD260 (no al revés)

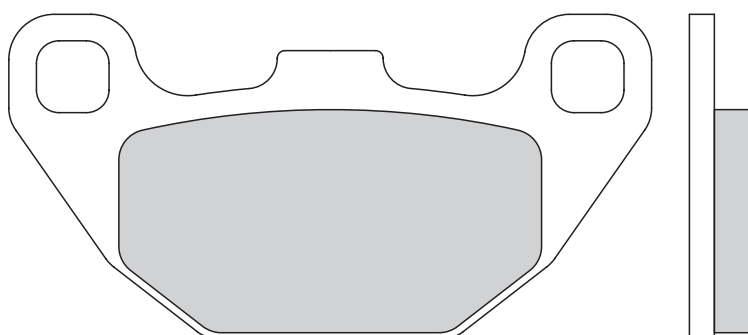
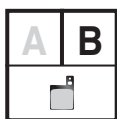
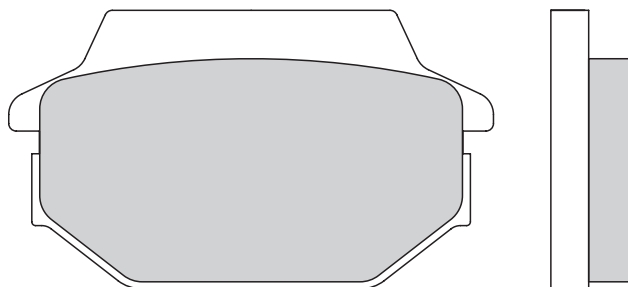
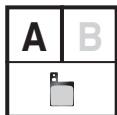

GALFER
FD
261
G1054
G1050
G1397

64,1
x
36,8
mm

10,8

85,0
x
44,0
mm

8,6

APPLICATIONS

PADS **FD**

DISCS **DF**

SHOES **MF**

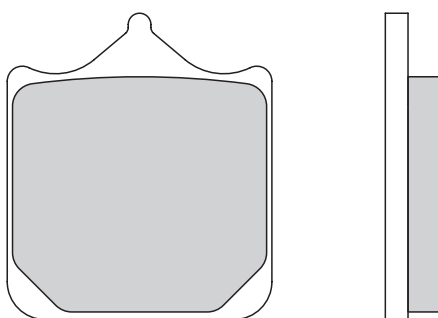
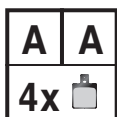

GALFER
FD
262
G1054
G1370
G1375

35,0
x
40,5
mm

7,5

LINES **FK**

BRACKETS **SP**

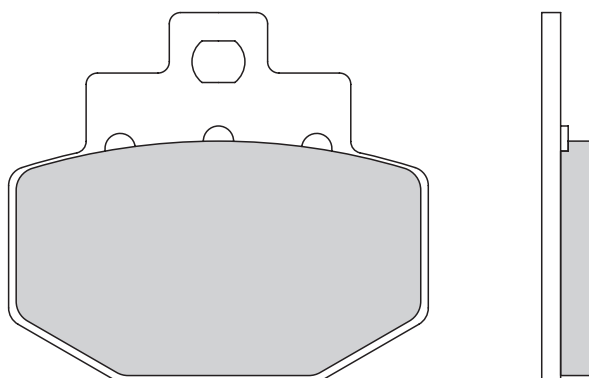
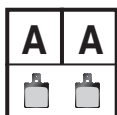

GALFER
FD
263
G1054
G1050

55,5
x
49,0
mm

7,0

KITS **KG**

CROSS REFERENCE



APPLICATIONS

GALFER
FD
265
G1054
G1396

PADS **FD**

↔ 61,5
mm x
↕ 31,1
↔ 6,5

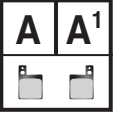
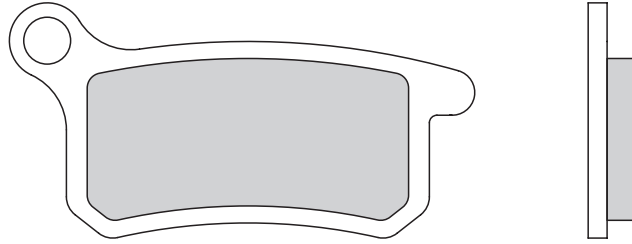

DISCS **DF**

GALFER
FD
266
G1054
G1050
G1370
G1375/R
G1380

SHOES **MF**

↔ 102,1
mm x
↕ 38,7
↔ 8,3

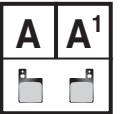
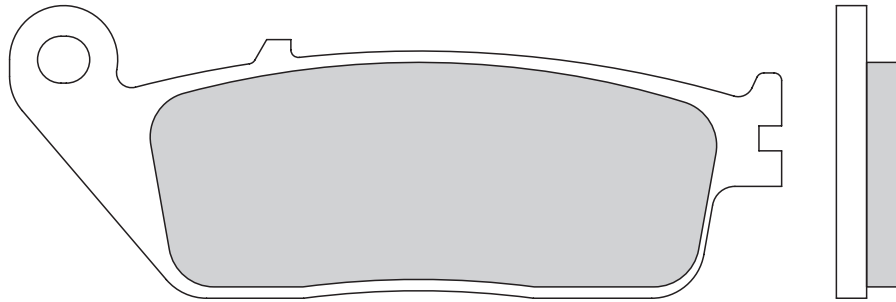

LINES **FK**

GALFER
FD
267
G1054
G1371

BRACKETS **SP**

↔ 59,8
mm x
↕ 57,2
↔ 9,5

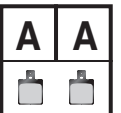
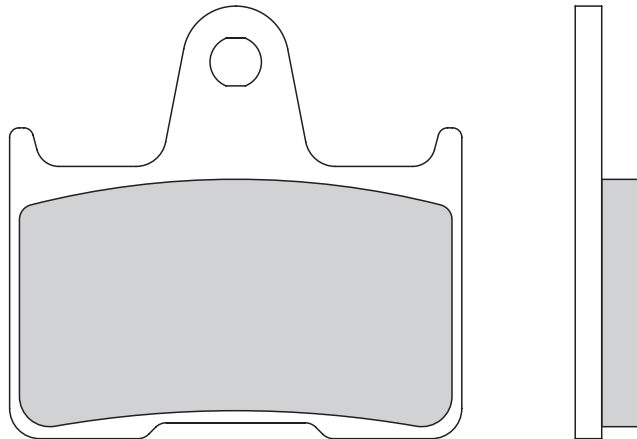

KITS **KG**

GALFER
FD
270
G1054
G1050
G1380

CROSS REFERENCE

↔ 50,0
mm x
↕ 47,2
↔ 6,8

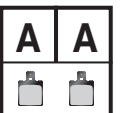
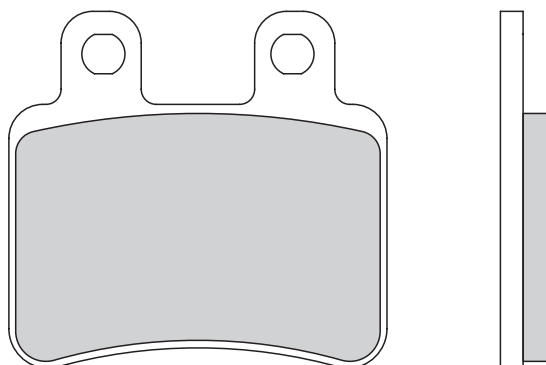

FD410 (th. 5,25mm) can replace FD270 (not vice versa) | FD410 (th. 5,25mm) puede sustituir FD270 (no al revés)

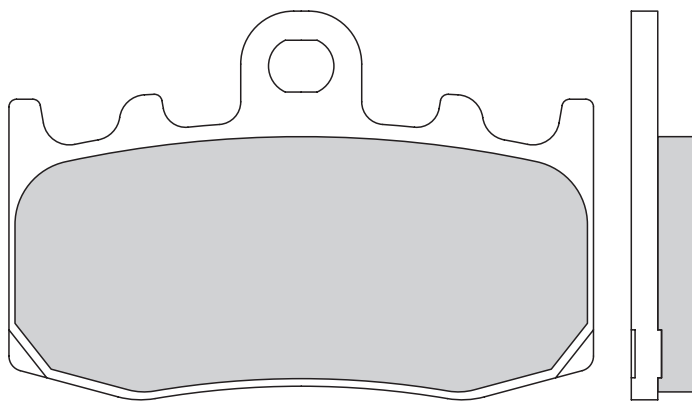
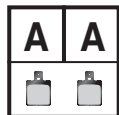

GALFER
FD
271
G1054
G1370
G1375

77,3
mm x
51,4

8,6

APPLICATIONS

PADS **FD**

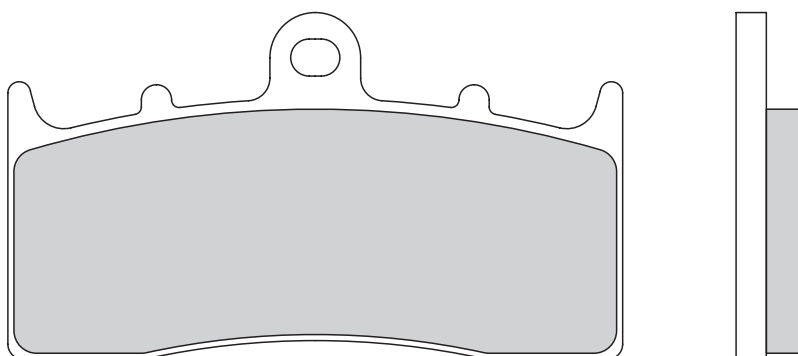
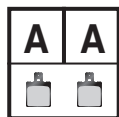

GALFER
FD
272
G1054
G1370

81,3
mm x
45,9

8,9

DISCS **DF**

SHOES **MF**

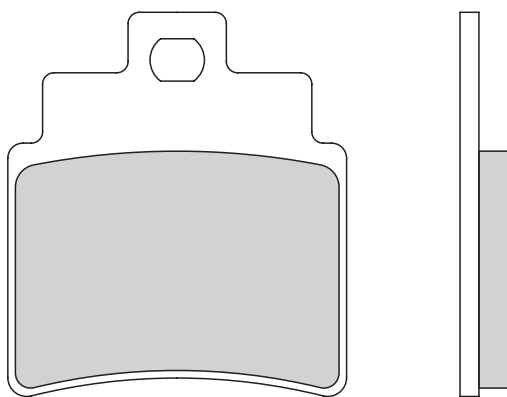
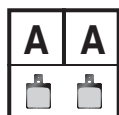

GALFER
FD
275
G1054
G1050
G1380
G1397

44,8
mm x
50,8

6,8

LINES **FK**

BRACKETS **SP**

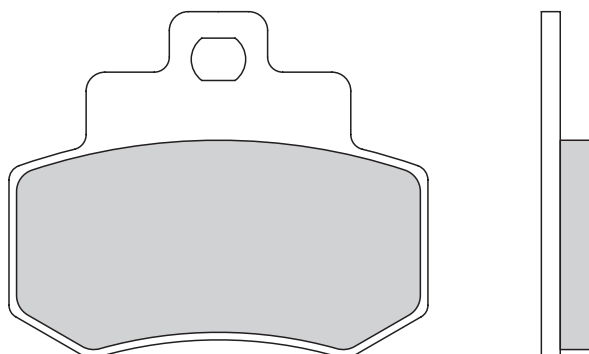
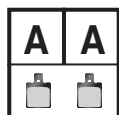

GALFER
FD
276
G1054

55,4
mm x
45,8

7,0

KITS **KG**

CROSS REFERENCE



APPLICATIONS

GALFER
FD
277
G1054
G1050
G1380

PADS **FD**

↔ 77,0
mm x
↑ 41,2
↔ 9,0

DISCS **DF**

↔ 96,9
mm x
↑ 41,2
↔ 9,0

SHOES **MF**

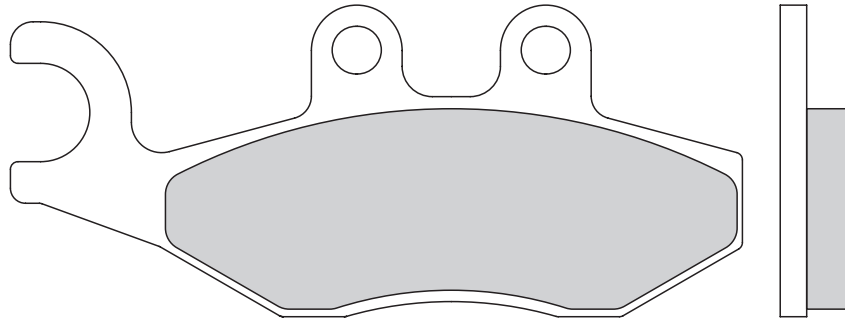
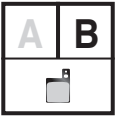
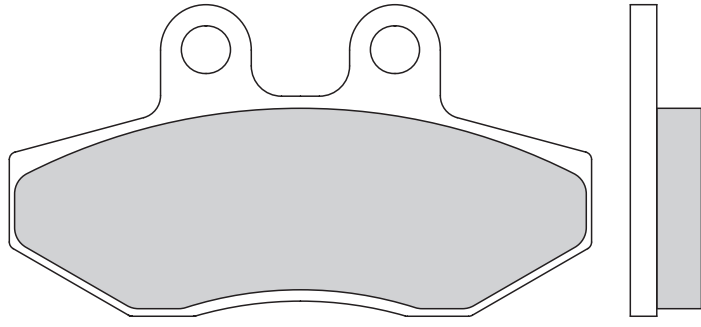
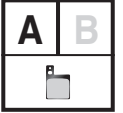

LINES **FK**

GALFER
FD
278
G1054
G1396
G1396R

BRACKETS **SP**

↔ 60,0
mm x
↑ 44,0
↔ 9,4

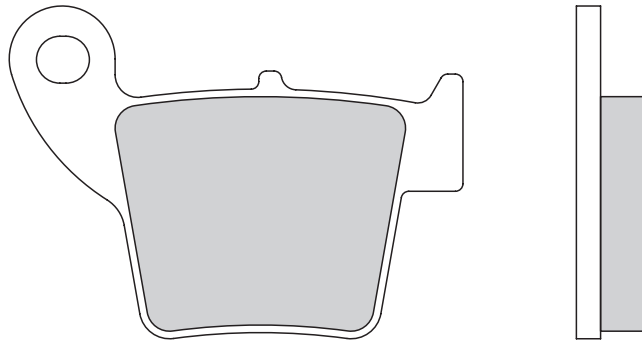
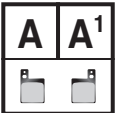

KITS **KG**

GALFER
FD
284
G1054
G1050
G1380

CROSS REFERENCE

↔ 81,8
mm x
↑ 42,3
↔ 9,3

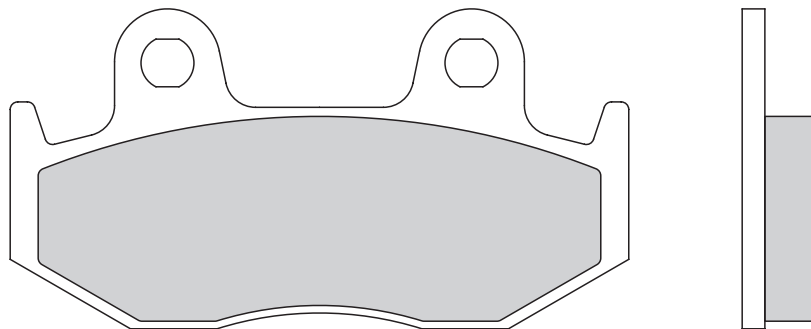
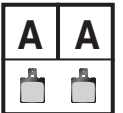

FD063 (th. 7,2mm) can replace FD284 (not vice versa) | FD063 (th. 7,2mm) puede sustituir FD284 (no al revés)

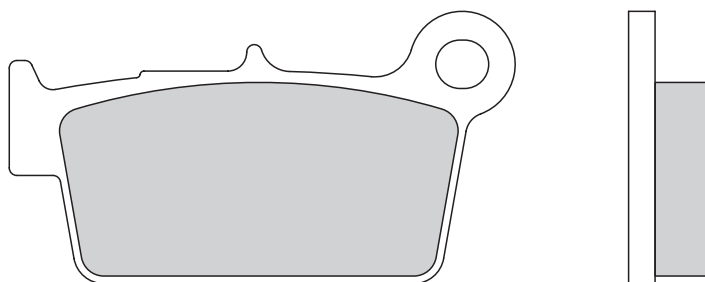
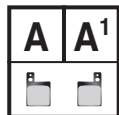

FD456 (th. 9,0mm) can replace **FD286** (not vice versa) | FD456 (th. 9,0mm) puede sustituir **FD286** (no al revés)

GALFER
FD
286
G1054
G1396
G1396R

66,85
mm x
36,0

10,5

APPLICATIONS

PADS **FD**

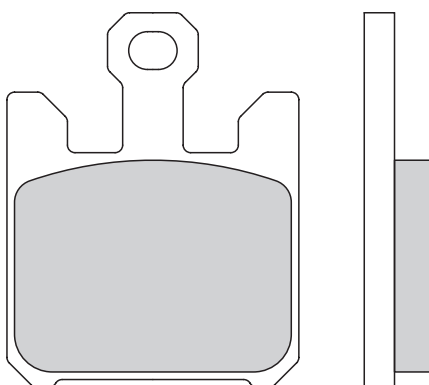
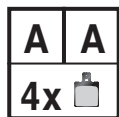

GALFER
FD
290
G1054
G1370
G1375

38,7
mm x
49,6

9,0

DISCS **DF**

SHOES **MF**

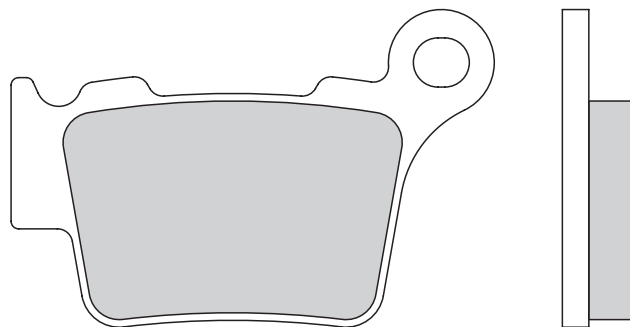
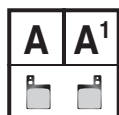

GALFER
FD
291
G1054
G1396
G1396R

63,9
mm x
42,0

9,5

LINES **FK**

BRACKETS **SP**

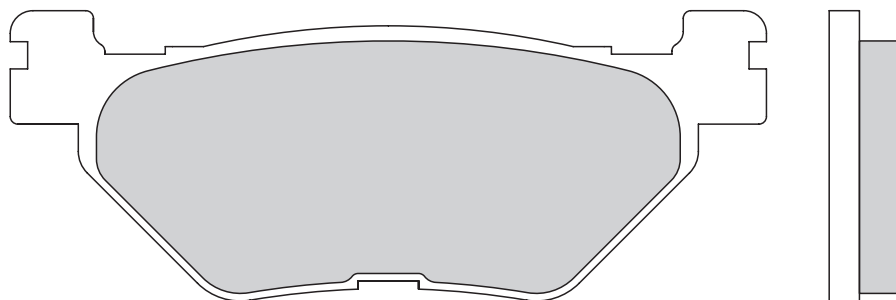
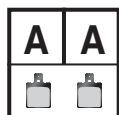

GALFER
FD
295
G1054
G1371

100,0
mm x
38,4

9,5

KITS **KG**

CROSS REFERENCE



APPLICATIONS

GALFER
FD
297
G1054
G1050

PADS **FD**

↔ 76,8
mm x
↕ 41,8
↔ 7,5

DISCS **DF**

↔ 94,5
mm x
↕ 42,0
↔ 7,5

SHOES **MF**

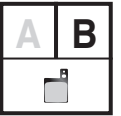
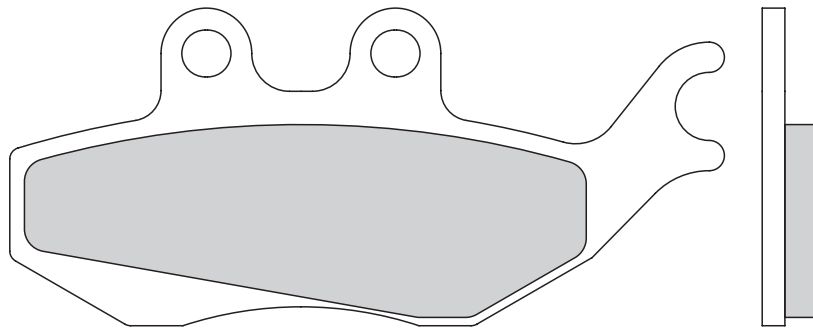
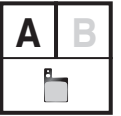
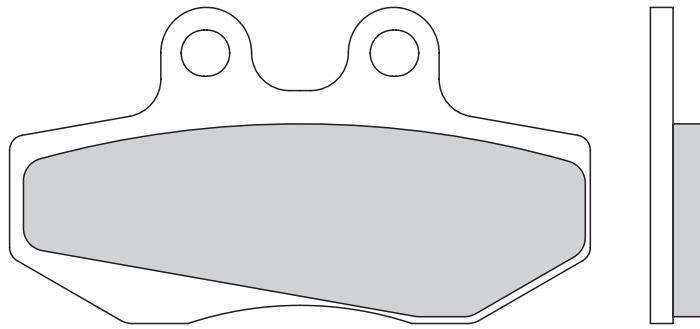

LINES **FK**

GALFER
FD
298
G1054
G1050
G1370

BRACKETS **SP**

↔ 98,5
mm x
↕ 33,1
↔ 7,6

KITS **KG**

↔ 111,2
mm x
↕ 36,2
↔ 7,6

CROSS REFERENCE

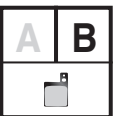
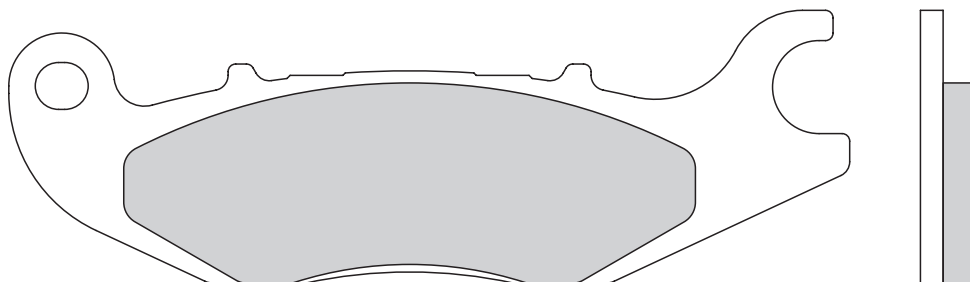
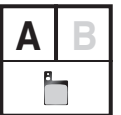
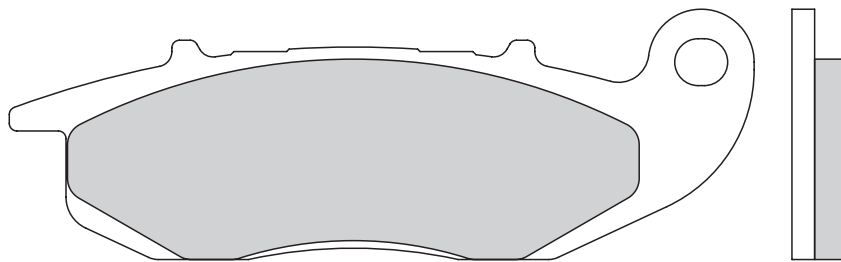

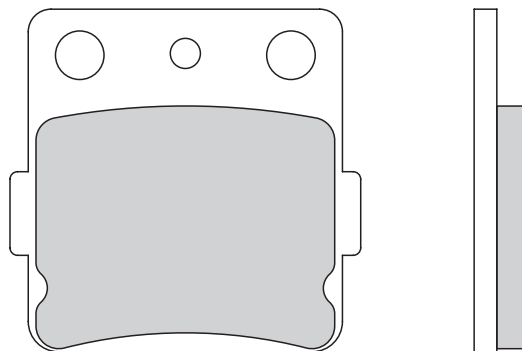
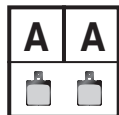

GALFER
FD
299
G1054
G1396

46,4
mm x
45,3
6,5

APPLICATIONS

PADS **FD**

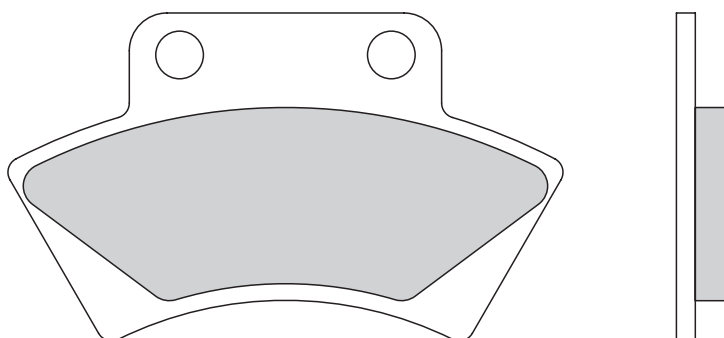
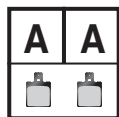

GALFER
FD
300
G1054
G1397

73,4
mm x
43,4
7,0

DISCS **DF**

SHOES **MF**

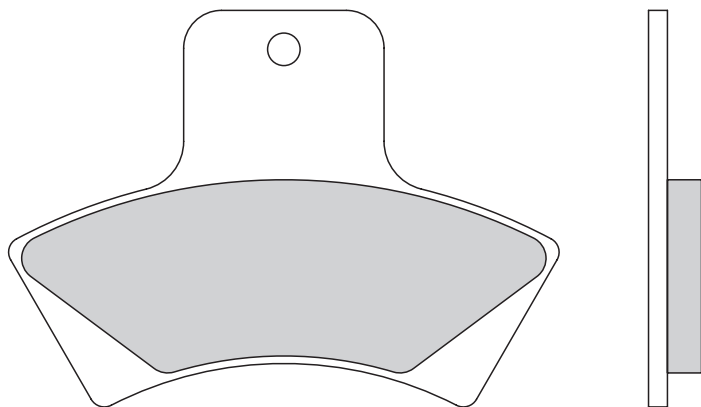
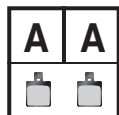

GALFER
FD
301
G1054
G1397

72,8
mm x
52,4
7,0

LINES **FK**

BRACKETS **SP**

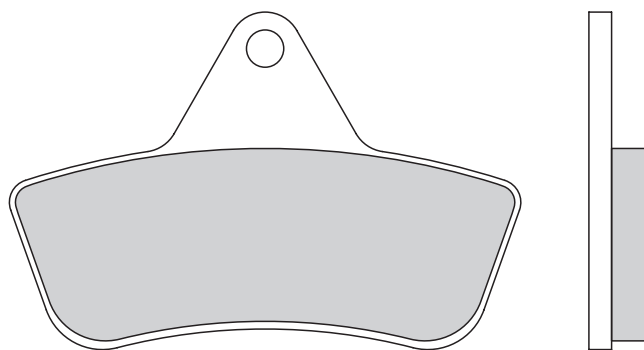
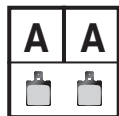

GALFER
FD
302
G1397

67,3
mm x
44,6
7,8

KITS **KG**

CROSS REFERENCE



APPLICATIONS

GALFER
FD
303
G1054
G1397

↔ 96,8
mm x
↕ 38,9
↔ 7,0

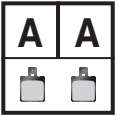
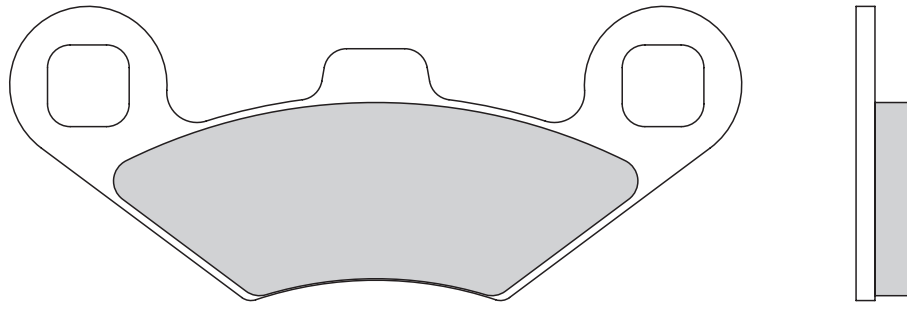

PADS **FD**

DISCS **DF**

GALFER
FD
304
G1054
G1375

↔ 35,0
mm x
↕ 46,0
↔ 7,6

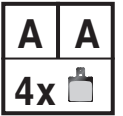
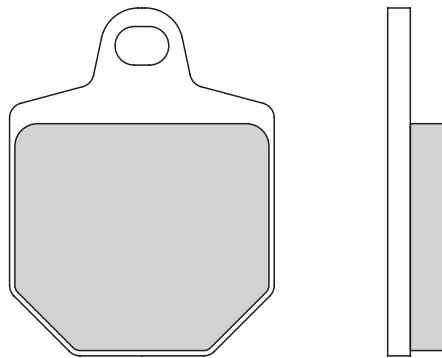

SHOES **MF**

LINES **FK**

GALFER
FD
315
G1054
G1050
G1397

↔ 62,0
mm x
↕ 40,6
↔ 9,5

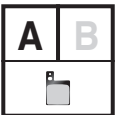
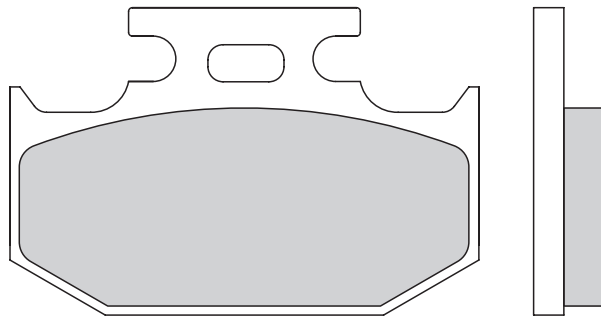

BRACKETS **SP**

KITS **KG**

↔ 82,0
mm x
↕ 40,7
↔ 9,5

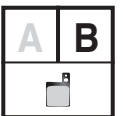
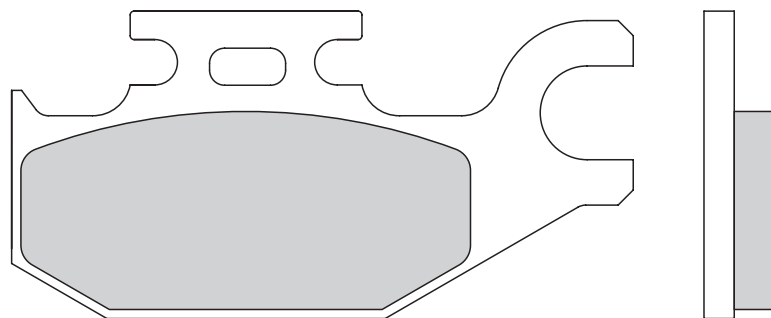

CROSS REFERENCE

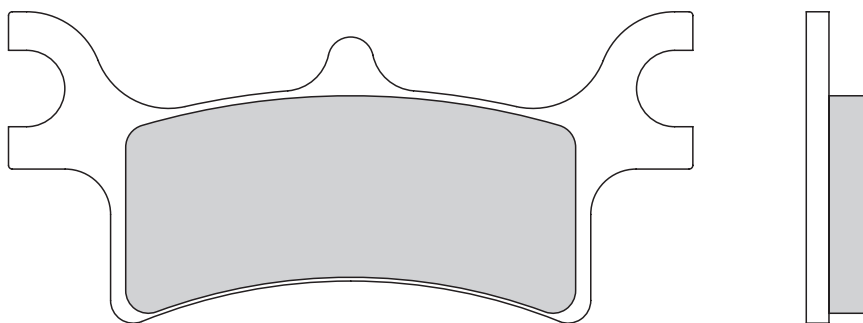
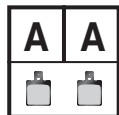

GALFER
FD
317
G1397

↔ 90,3
mm x
↕ 41,2
↔ 8,2

APPLICATIONS

PADS **FD**

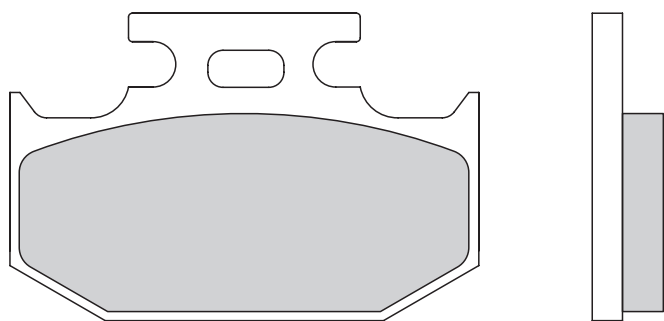
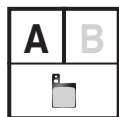

GALFER
FD
318
G1054
G1397

↔ 62,0
mm x
↕ 40,6
↔ 9,5

DISCS **DF**

SHOES **MF**

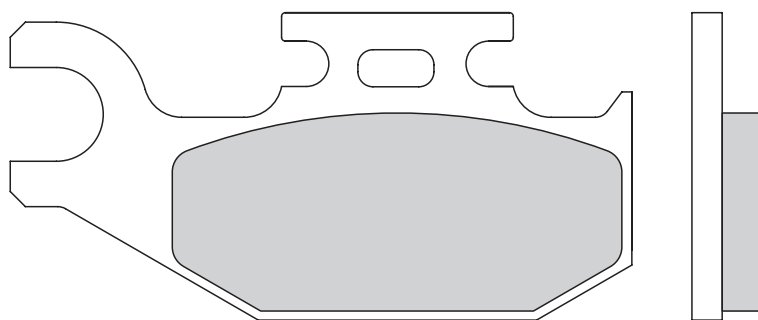
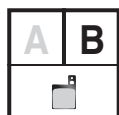

↔ 82,0
mm x
↕ 40,7
↔ 9,5

LINES **FK**

BRACKETS **SP**

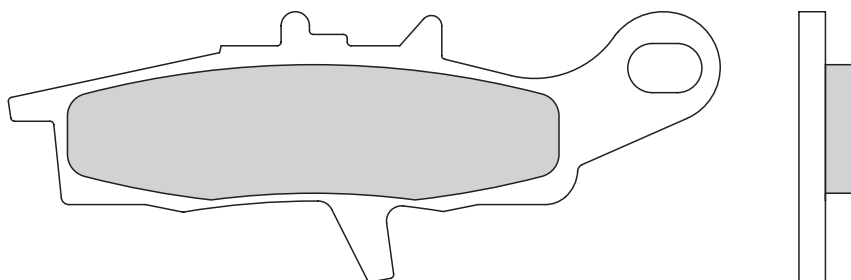
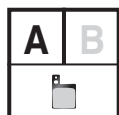

GALFER
FD
319
G1397

↔ 94,7
mm x
↕ 35,6
↔ 7,5

KITS **KG**

CROSS REFERENCE



APPLICATIONS

	119,5
mm	x
	26,4
	7,1

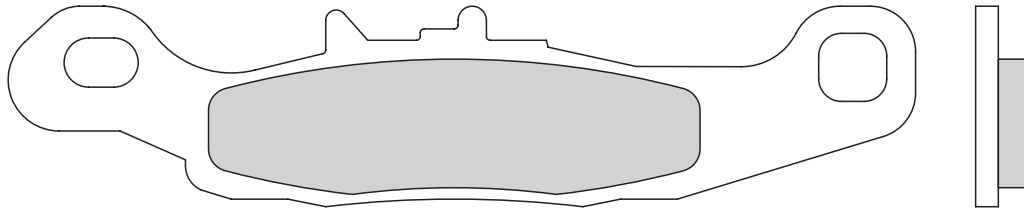
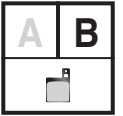

PADS **FD**

DISCS **DF**

GALFER
FD
320
G1054

	65,5
mm	x
	44,8
	11,7

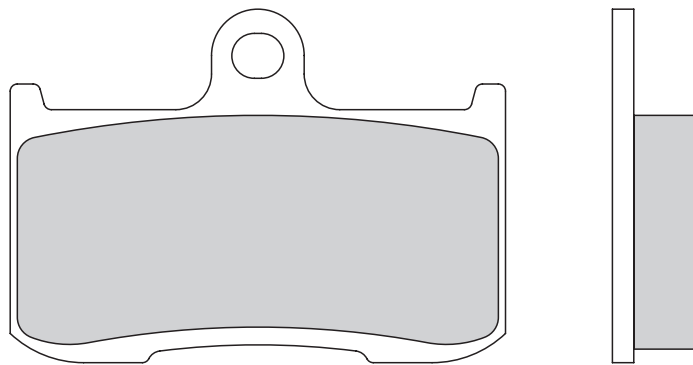
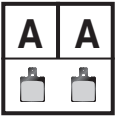

SHOES **MF**

LINES **FK**

GALFER
FD
321
G1397

	94,7
mm	x
	35,6
	7,5

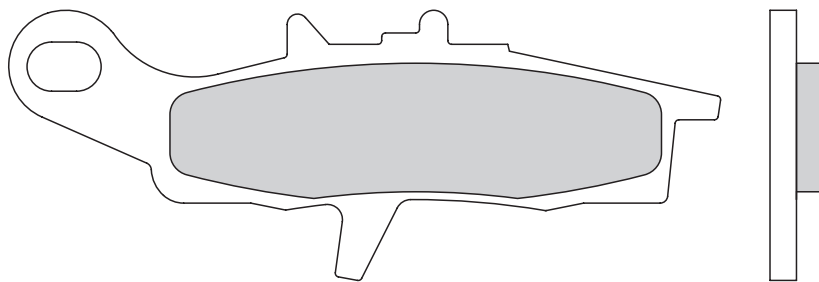
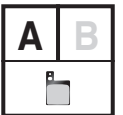

BRACKETS **SP**

KITS **KG**

	119,5
mm	x
	26,4
	7,1

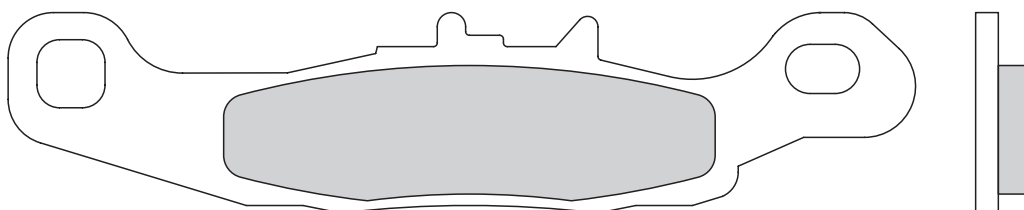
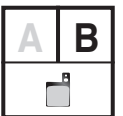

CROSS REFERENCE

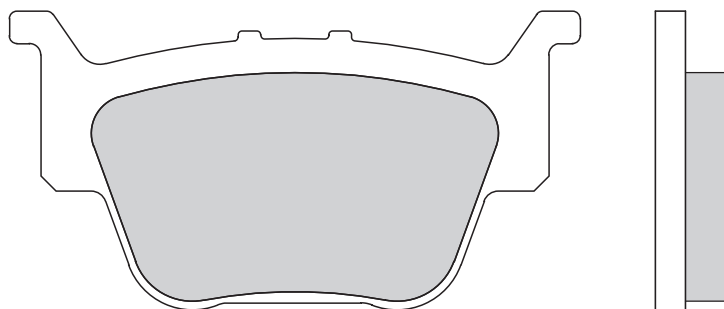
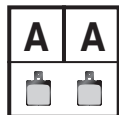

GALFER
FD
323
G1054
G1397

75,5
mm x
39,5

9,6

APPLICATIONS

PADS **FD**

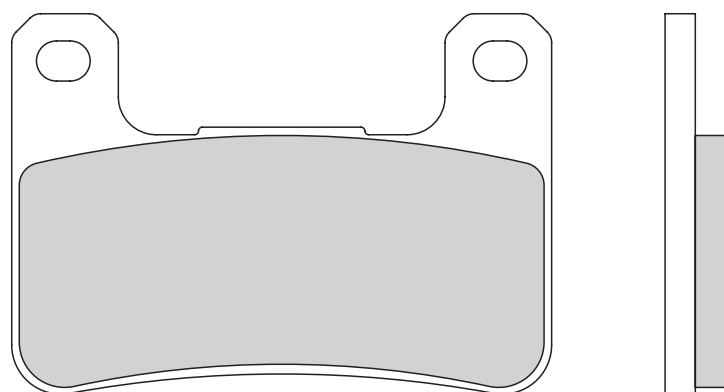
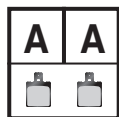

GALFER
FD
325
G1054
G1370
G1375
G1375R

71,4
mm x
50,0

8,0

DISCS **DF**

SHOES **MF**

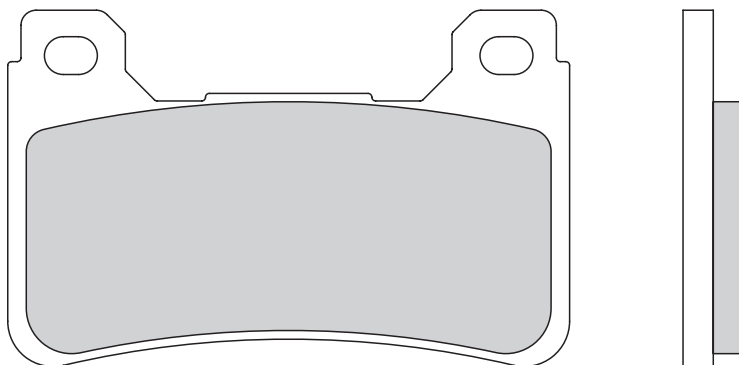
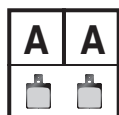

GALFER
FD
326
G1054
G1370
G1375
G1375R

74,3
mm x
47,1

7,9

LINES **FK**

BRACKETS **SP**

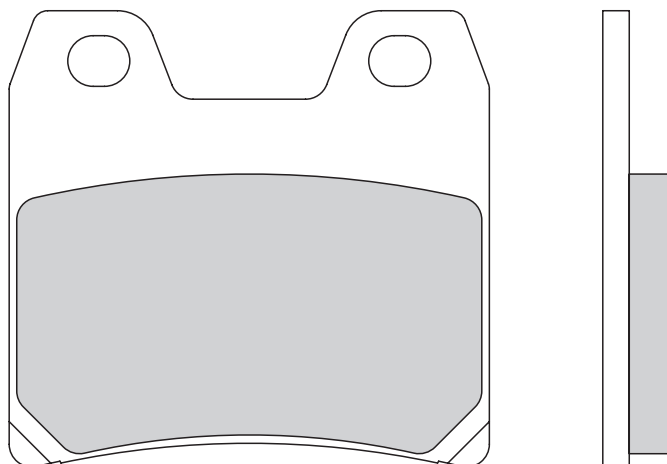
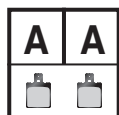

GALFER
FD
329
G1054
G1371

63,4
mm x
60,7

8,9

KITS **KG**

CROSS REFERENCE



APPLICATIONS

GALFER
FD
331
G1054
G1370
G1375
G1375R

↔ 69,5
mm x
↑↓ 49,6
↔ 7,0

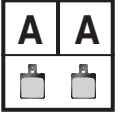
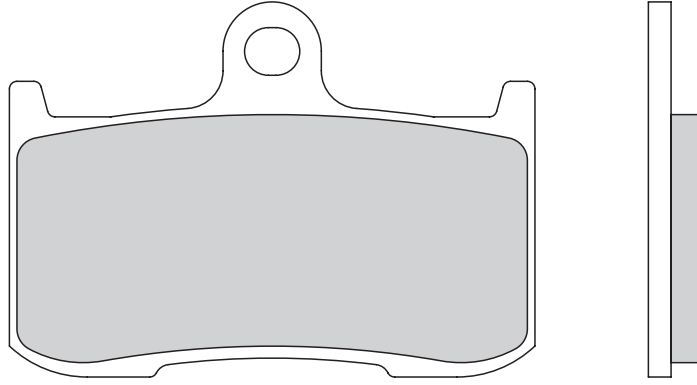

PADS **FD**

DISCS **DF**

GALFER
FD
334
G1054
G1050
G1380

↔ 77,0
mm x
↑↓ 41,2
↔ 9,0

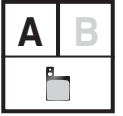
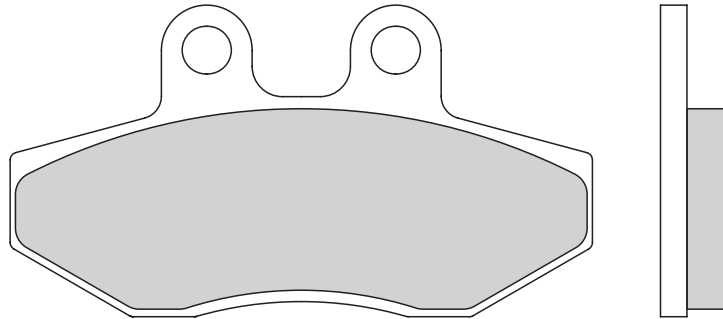

SHOES **MF**

LINES **FK**

↔ 96,9
mm x
↑↓ 41,2
↔ 9,0

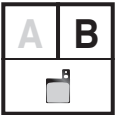
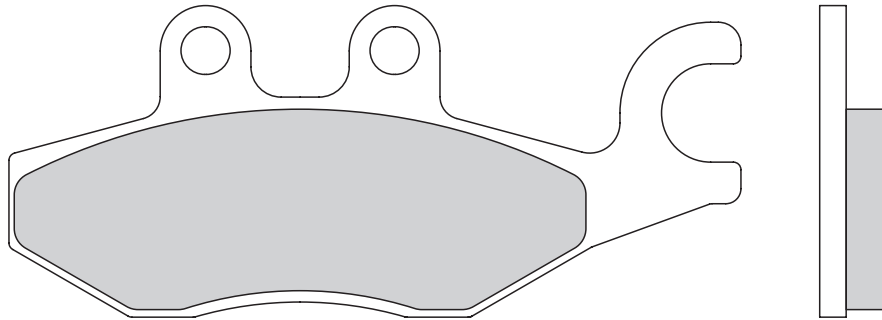

BRACKETS **SP**

KITS **KG**

GALFER
FD
335
G1054
G1805

↔ 41,0
mm x
↑↓ 44,7
↔ 6,4

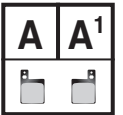
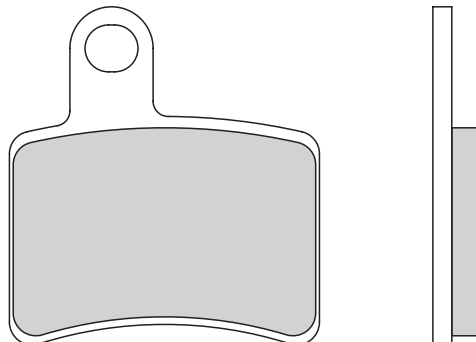

CROSS REFERENCE

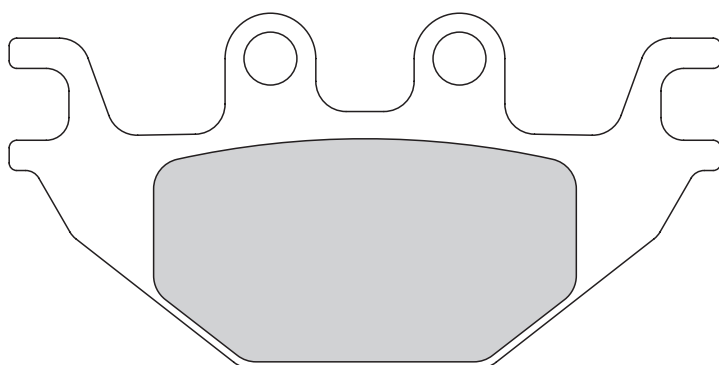
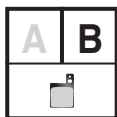
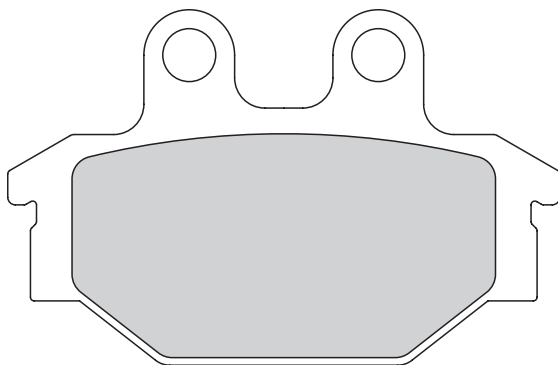
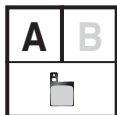

GALFER
FD
336
G1054
G1397

↔ 73,0
mm x
↕ 47,0

⌋ 10,8

↔ 94,1
mm x
↕ 47,0

⌋ 8,6

APPLICATIONS

PADS **FD**

DISCS **DF**

SHOES **MF**

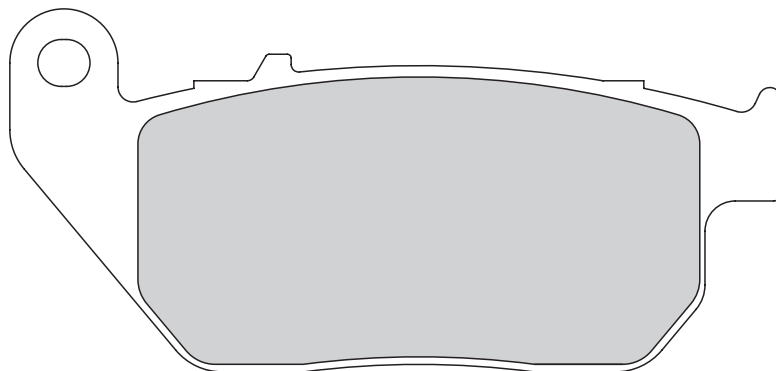
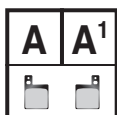

GALFER
FD
339
G1370

↔ 102,0
mm x
↕ 45,9

⌋ 10,0

LINES **FK**

BRACKETS **SP**

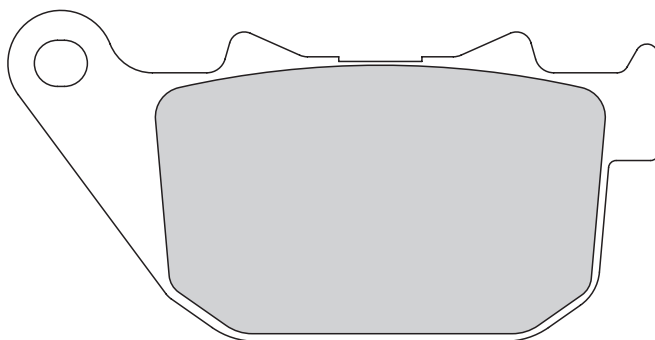
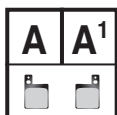

GALFER
FD
340
G1371

↔ 86,0
mm x
↕ 44,5

⌋ 10,4

KITS **KG**

CROSS REFERENCE



APPLICATIONS

GALFER
FD
341
G1054
G1050

↔ 69,9
mm x
↕ 51,6
↔ 7,5

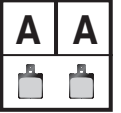
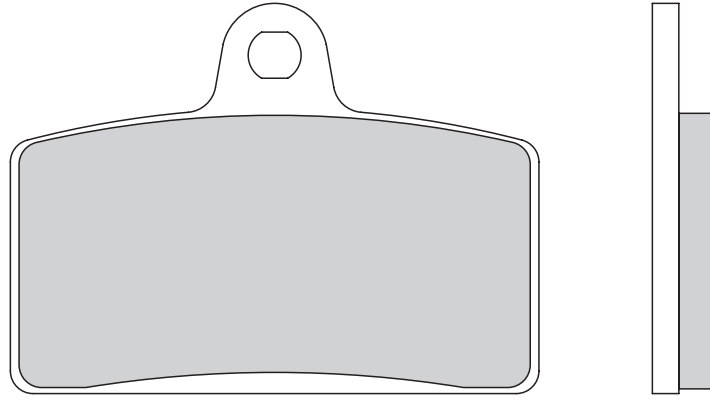

PADS **FD**

DISCS **DF**

GALFER
FD
342
G1054
G1050

↔ 77,0
mm x
↕ 41,2
↔ 9,4

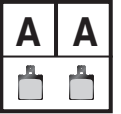
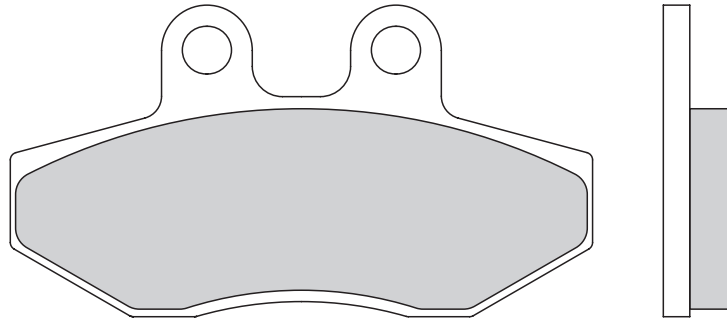

SHOES **MF**

LINES **FK**

GALFER
FD
343
G1054
G1050
G1380

↔ 55,3
mm x
↕ 52,1
↔ 7,6

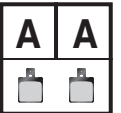
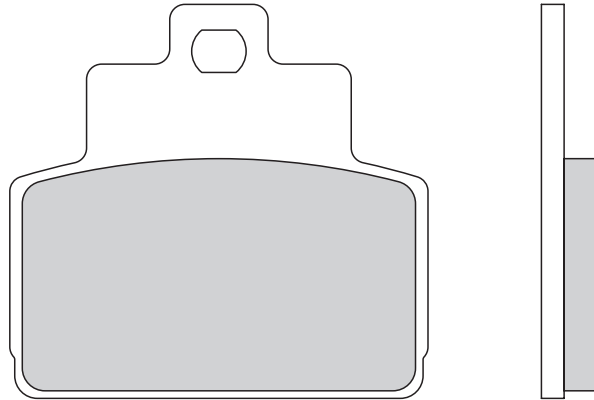

BRACKETS **SP**

KITS **KG**

GALFER
FD
344
G1054
G1050
G1370
G1375/R
G1380

↔ 118,0
mm x
↕ 45,2
↔ 9,2

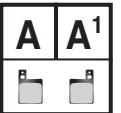
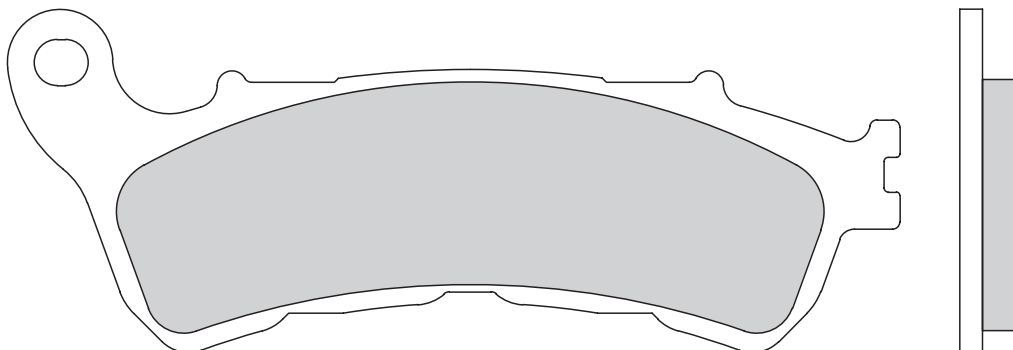

CROSS REFERENCE

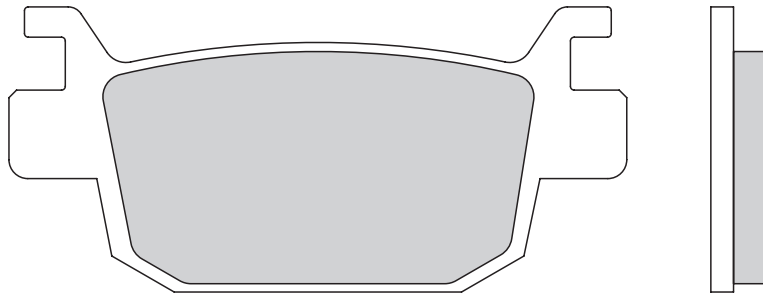
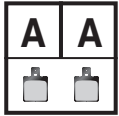

GALFER
FD
345
G1054
G1050
G1380

81,7
mm x
37,7
8,8

APPLICATIONS

PADS **FD**

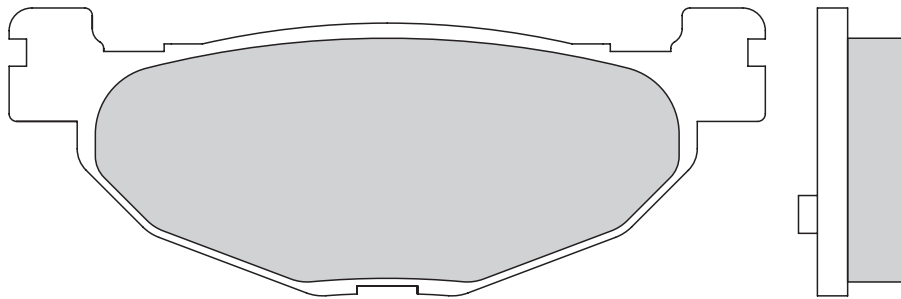
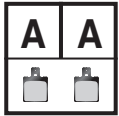

GALFER
FD
352
G1054
G1380

100,0
mm x
38,1
12,0

DISCS **DF**

SHOES **MF**

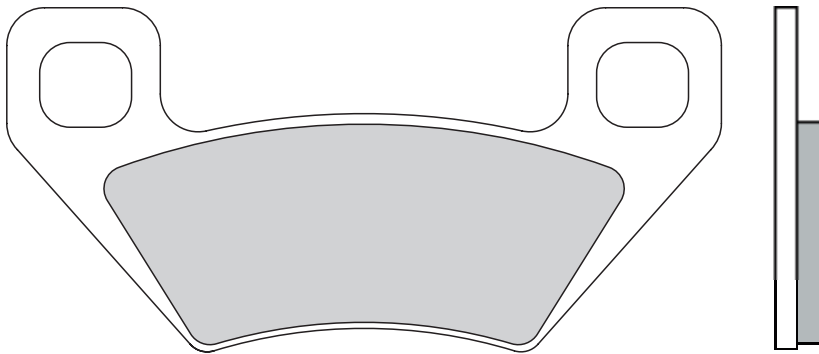
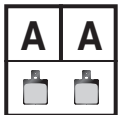

GALFER
FD
353
G1054
G1397

94,5
mm x
45,5
7,0

LINES **FK**

BRACKETS **SP**

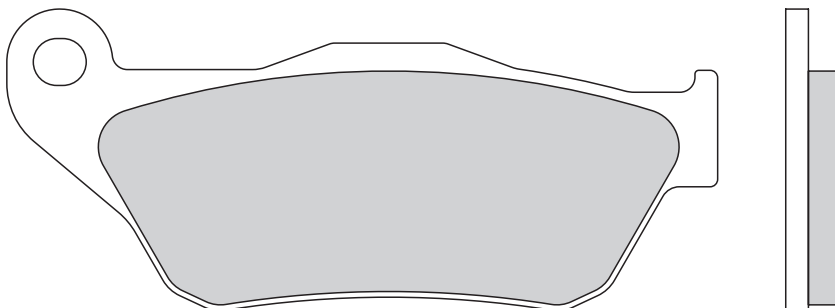
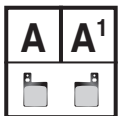

GALFER
FD
355
G1054
G1050
G1380

94,0
mm x
39,9
7,5

KITS **KG**

CROSS REFERENCE



APPLICATIONS

GALFER
FD
356
G1054

↔ 39,7
mm x
↑ 44,5
↔ 7,0

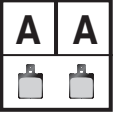
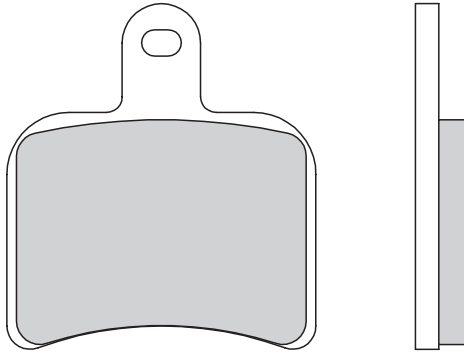

PADS **FD**

DISCS **DF**

GALFER
FD
359
G1054
G1371

↔ 89,2
mm x
↑ 40,6
↔ 9,8

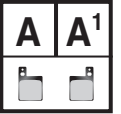
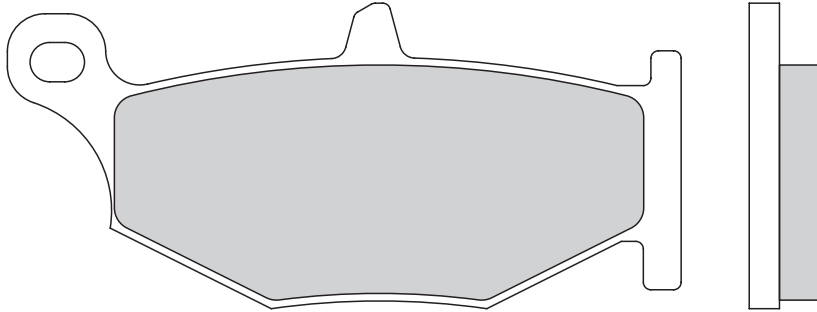

SHOES **MF**

LINES **FK**

GALFER
FD
360
G1054

↔ 55,5
mm x
↑ 42,0
↔ 7,0

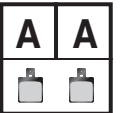
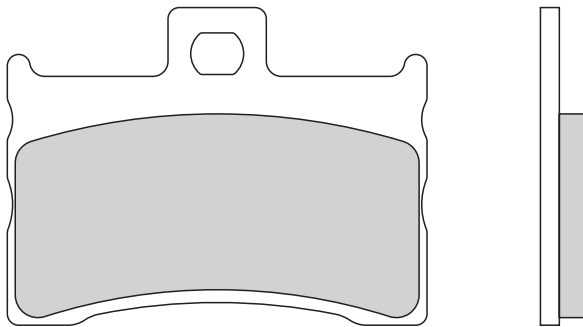

BRACKETS **SP**

KITS **KG**

GALFER
FD
362
G1054
G1396

↔ 75,6
mm x
↑ 41,1
↔ 8,2

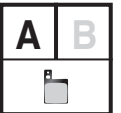
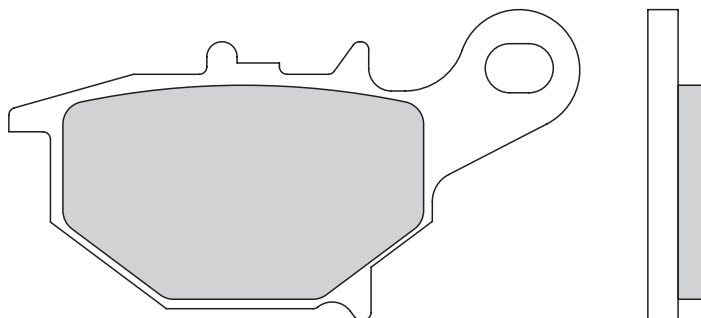

CROSS REFERENCE

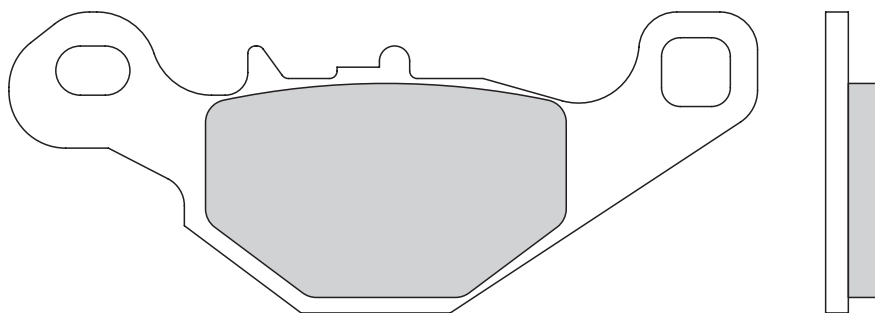
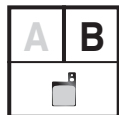

	99,0
mm	x
	39,8
	7,5

APPLICATIONS

PADS **FD**

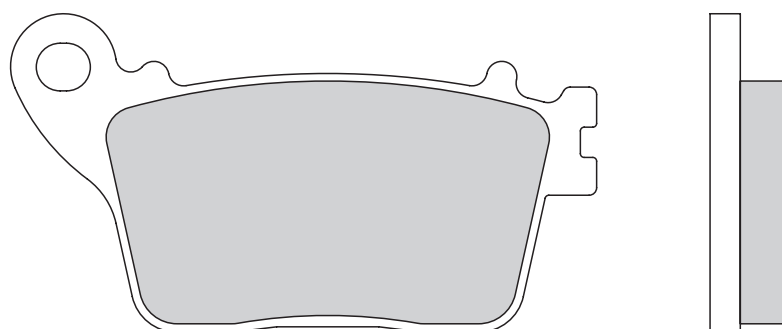
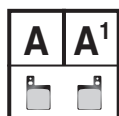

GALFER
FD
363
G1054
G1371

	77,5
mm	x
	42,1
	10,4

DISCS **DF**

SHOES **MF**

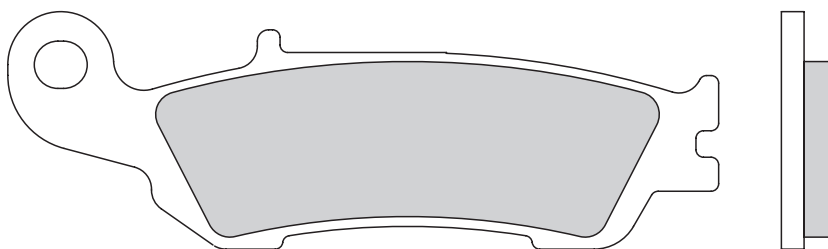
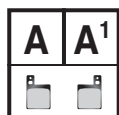

GALFER
FD
364
G1054
G1396
G1396R

	94,0
mm	x
	31,5
	7,15

LINES **FK**

BRACKETS **SP**

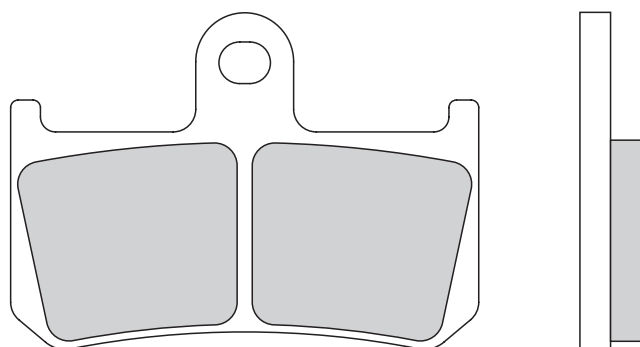
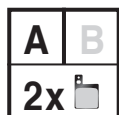

GALFER
FD
365
G1375

	30,9
mm	x
	48,0
	8,5

KITS **KG**

CROSS REFERENCE



APPLICATIONS

	61,9
mm	x
	44,8
	8,5

A	B
2x	

PADS **FD**

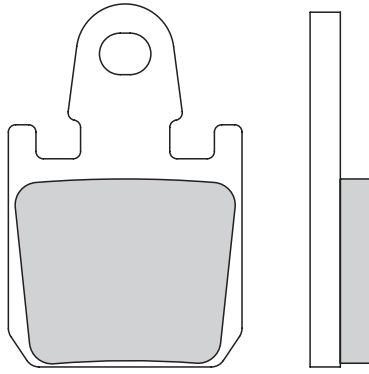

DISCS **DF**

GALFER	
FD	
367	
G1054	
G1375	

A	A

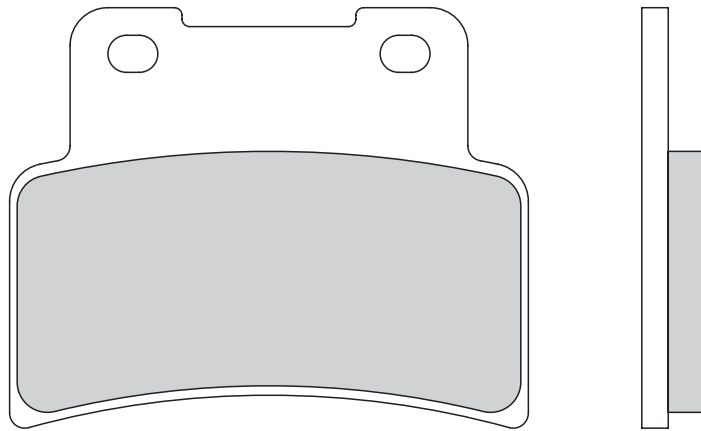

SHOES **MF**

	68,6
mm	x
	55,6
	8,8

LINES **FK**

GALFER	
FD	
369	
G1370	

A	A'

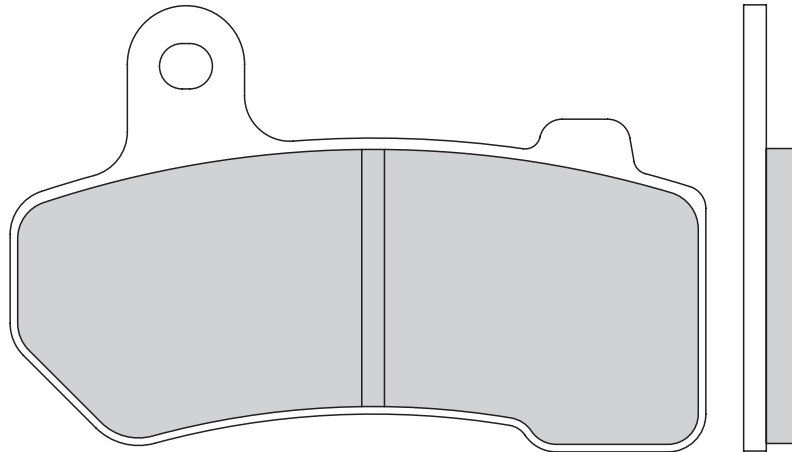

BRACKETS **SP**

	91,9
mm	x
	58,5
	7,0

KITS **KG**

GALFER	
FD	
371	
G1370	
G1375	
G1375R	

A	A
4x	

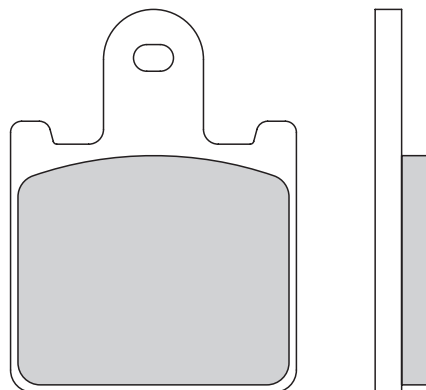
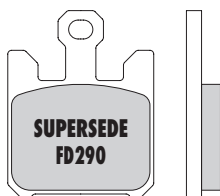

CROSS REFERENCE

	37,7
mm	x
	49,9
	7,8

FD290 replace FD371 (not vice versa) | FD290 sustituye a FD371 (no al revés)

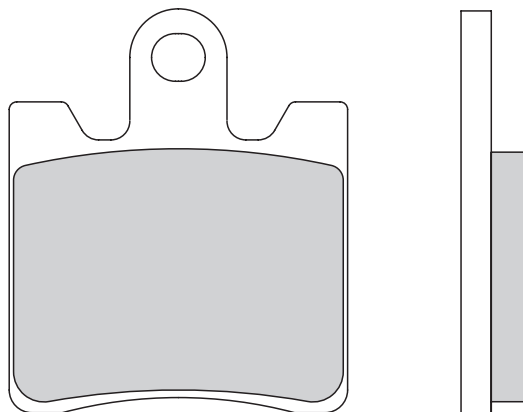

GALFER
FD
372
G1370
G1375

44,8
x
53,6
mm

8,7

APPLICATIONS

PADS **FD**

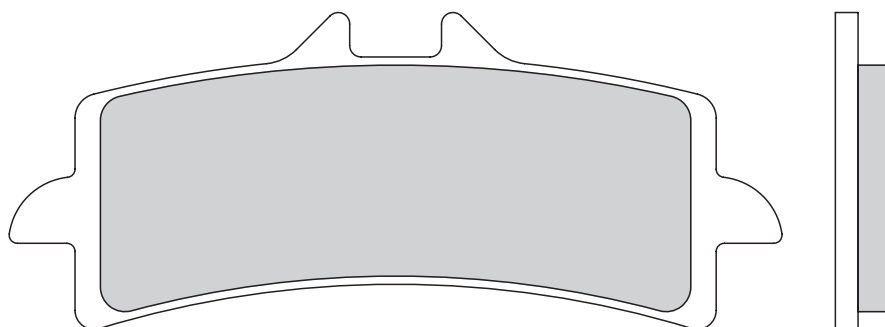
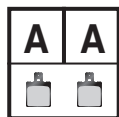

GALFER
FD
373
G1370
G1375
G1375R

102,2
x
41,9
mm

7,5

DISCS **DF**

SHOES **MF**

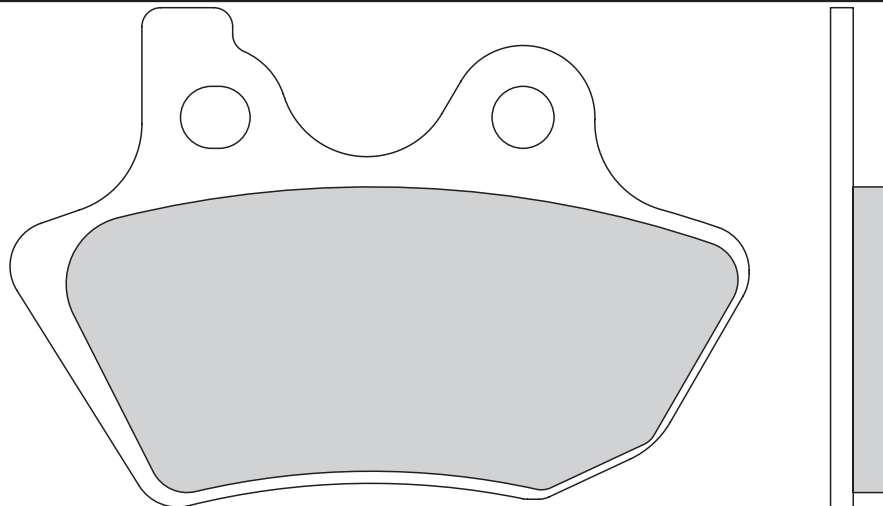
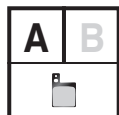

GALFER
FD
375
G1054
G1370

97,9
x
64,2
mm

8,0

LINES **FK**

BRACKETS **SP**

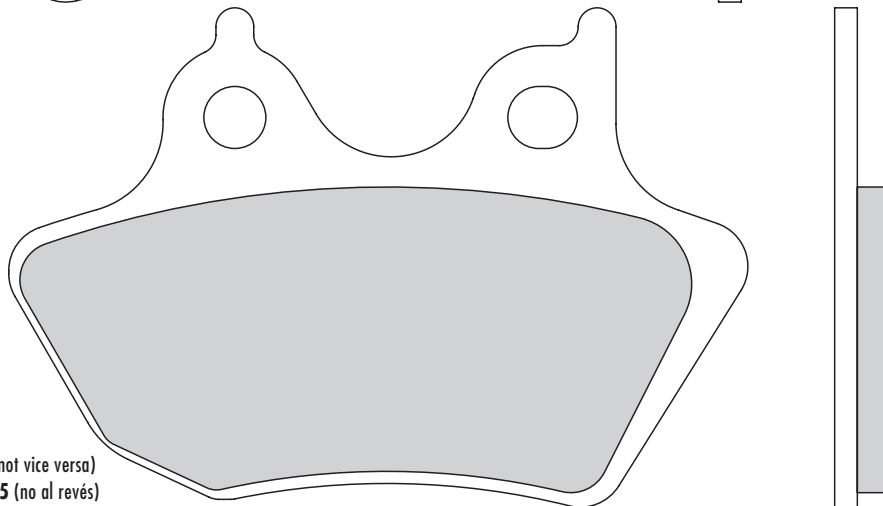
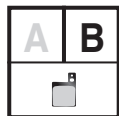

97,9
x
64,2
mm

8,0

KITS **KG**

CROSS REFERENCE

FD235 (th. 7,5mm) can replace FD375 (not vice versa)
FD235 (th. 7,5mm) puede sustituir FD375 (no al revés)



APPLICATIONS

GALFER
FD
378
G1397

↔ 91,7
mm x
↕ 38,2
↔ 8,0

↔ 107,0
mm x
↕ 33,8
↔ 8,0

PADS **FD**

DISCS **DF**

SHOES **MF**

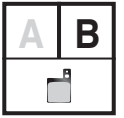
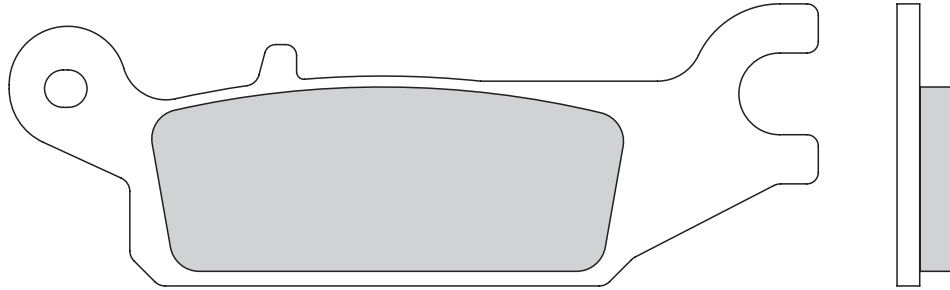
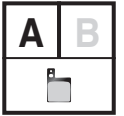
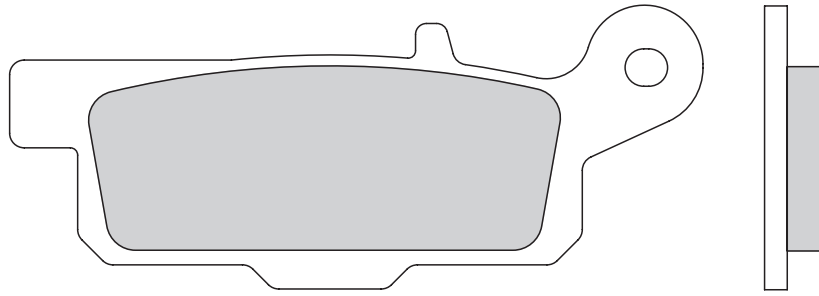

LINES **FK**

GALFER
FD
379
G1397

↔ 91,7
mm x
↕ 38,2
↔ 8,0

↔ 107,0
mm x
↕ 33,8
↔ 8,0

BRACKETS **SP**

KITS **KG**

CROSS REFERENCE

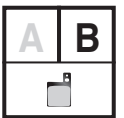
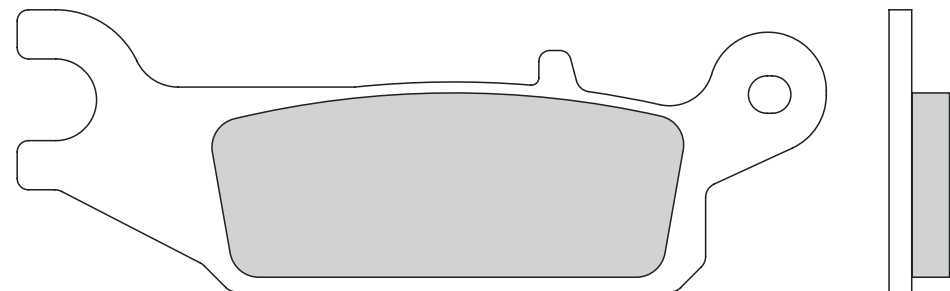
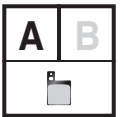
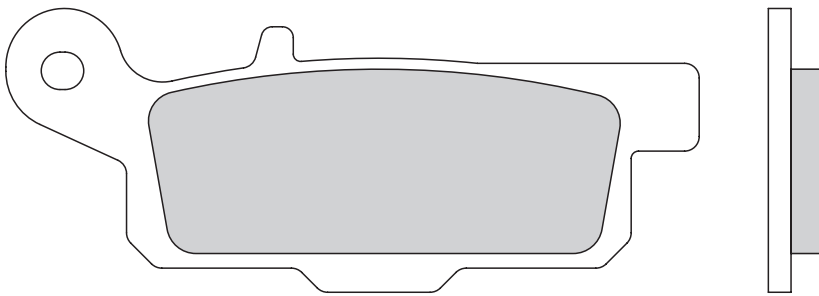

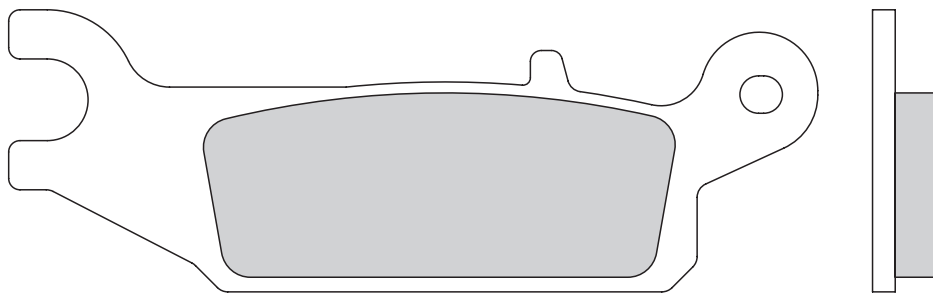
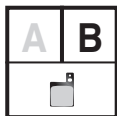
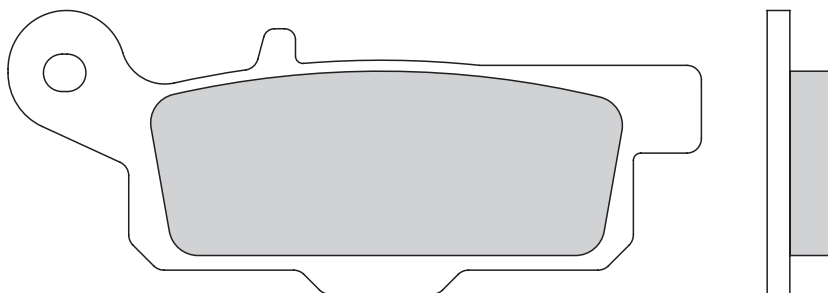
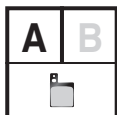
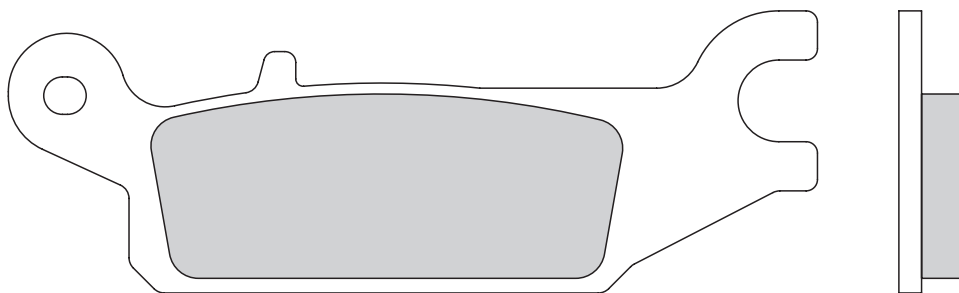
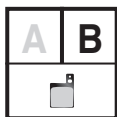
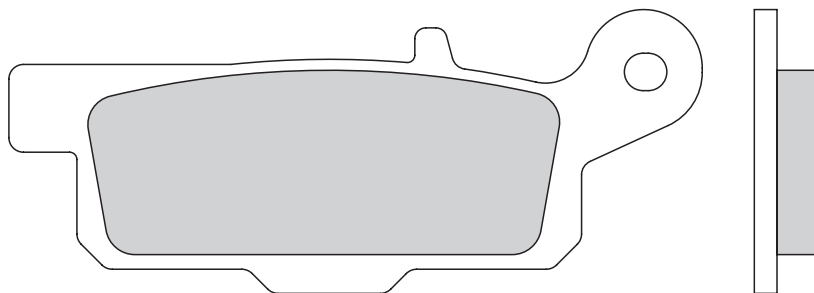
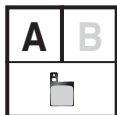

GALFER
FD
380
G1397

↔ 91,7
mm x
↕ 38,2

⏏ 9,0

↔ 107,0
mm x
↕ 33,8

⏏ 9,0

GALFER
FD
381
G1397

↔ 91,7
mm x
↕ 38,2

⏏ 9,0

↔ 107,0
mm x
↕ 33,8

⏏ 9,0

APPLICATIONS

PADS **FD**

DISCS **DF**

SHOES **MF**

LINES **FK**

BRACKETS **SP**

KITS **KG**

CROSS REFERENCE



APPLICATIONS

GALFER
FD
384
G1054
G1375

↔ 92,0
mm x
↕ 51,5
↔ 8,0

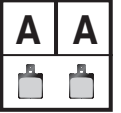
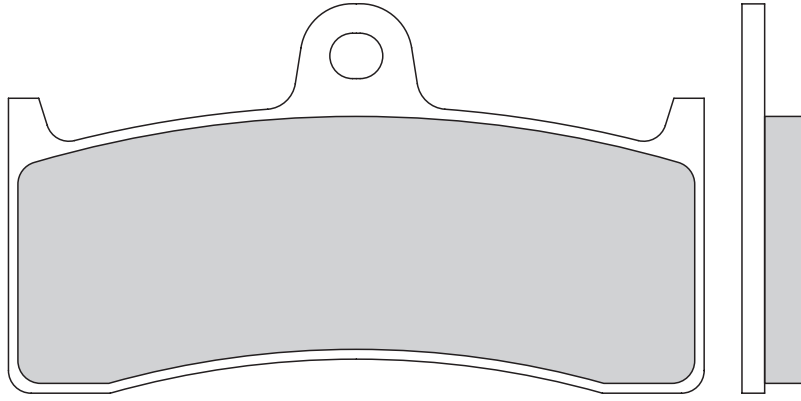

PADS **FD**

DISCS **DF**

GALFER
FD
393
G1054
G1050
G1370

↔ 95,6
mm x
↕ 36,9
↔ 8,4

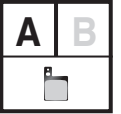
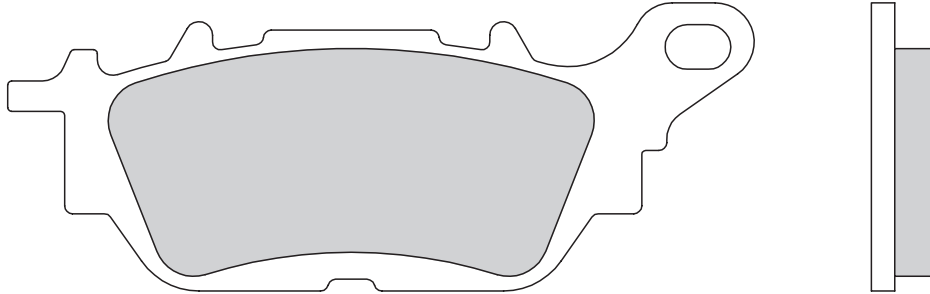

SHOES **MF**

LINES **FK**

↔ 109,6
mm x
↕ 51,2
↔ 8,4

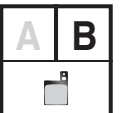
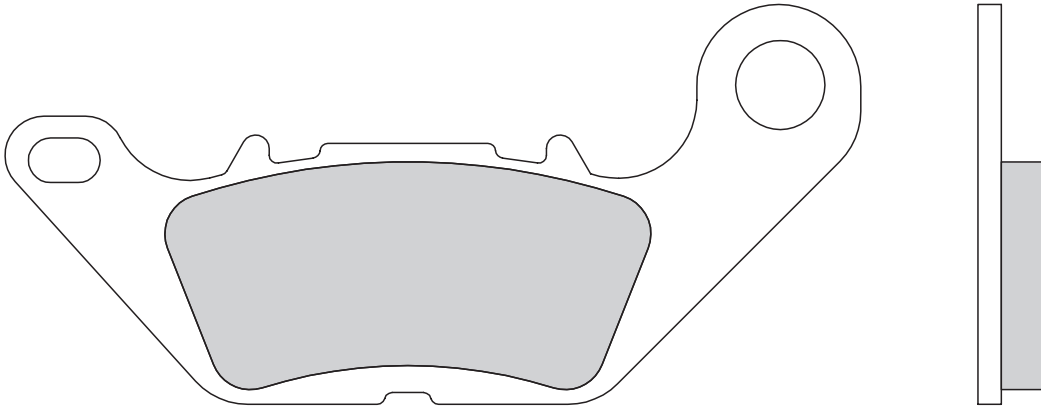

BRACKETS **SP**

KITS **KG**

GALFER
FD
399
G1054
G1050
G1380

↔ 94,0
mm x
↕ 36,1
↔ 10,1

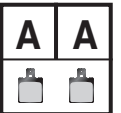
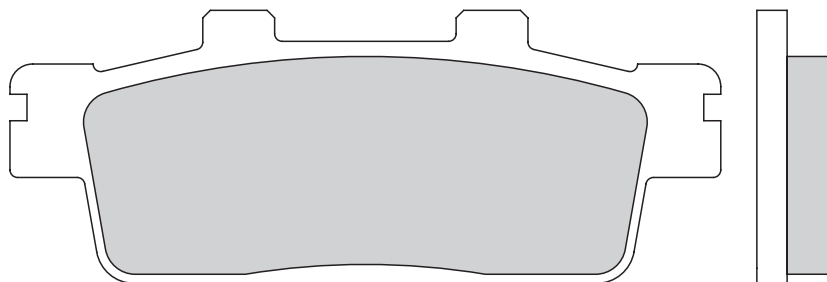

CROSS REFERENCE

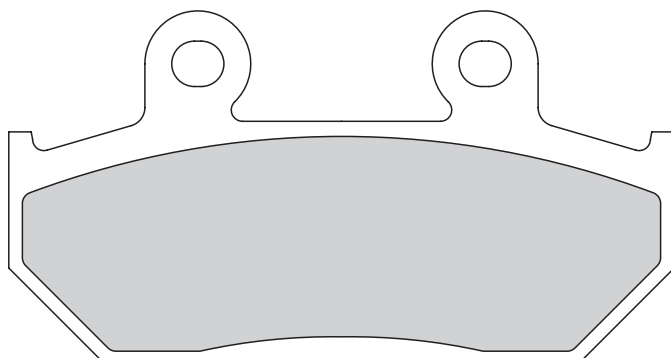
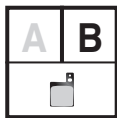
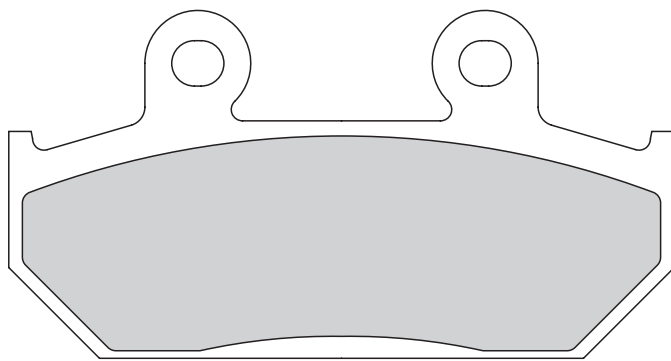
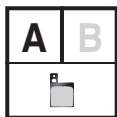
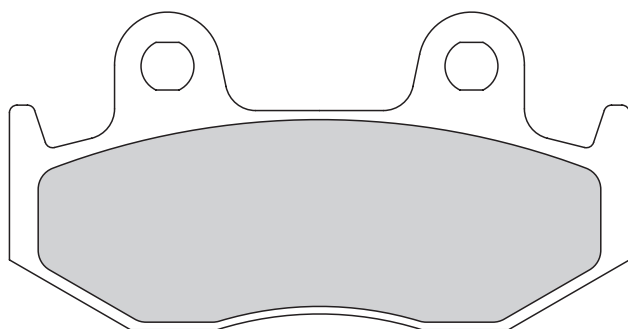
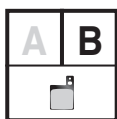
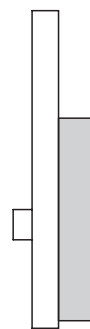
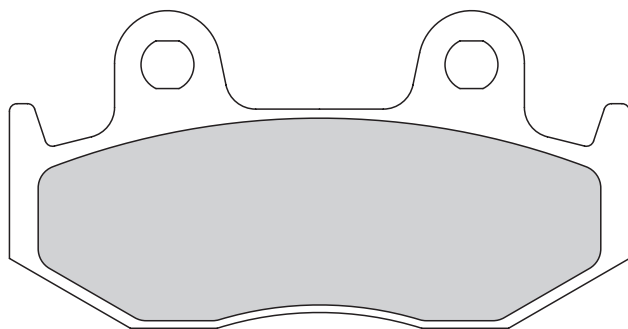
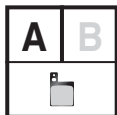

GALFER
FD
400
G1054
G1380

81,0
mm x
42,0

8,3

81,0
mm x
42,0

8,3

APPLICATIONS

PADS **FD**

DISCS **DF**

SHOES **MF**

GALFER
FD
401
G1054
G1380

88,0
mm x
46,0

8,4

88,0
mm x
46,0

8,4

LINES **FK**

BRACKETS **SP**

KITS **KG**

CROSS REFERENCE



APPLICATIONS

GALFER
FD
402
G1370
G1375

↔ 92,0
mm x
↕ 49,5
↔ 8,0

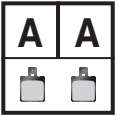
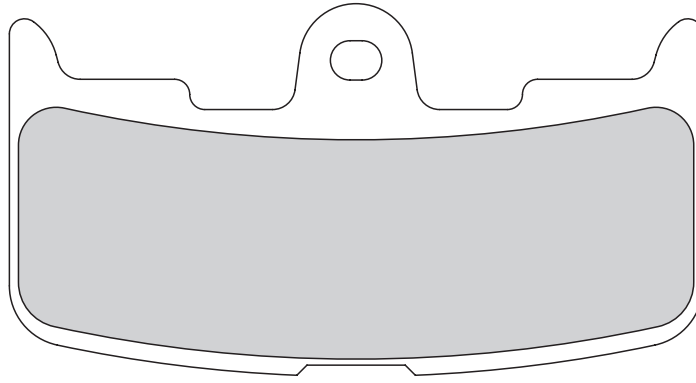

PADS **FD**

DISCS **DF**

GALFER
FD
404
G1397

↔ 97,1
mm x
↕ 46,8
↔ 7,6

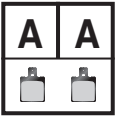
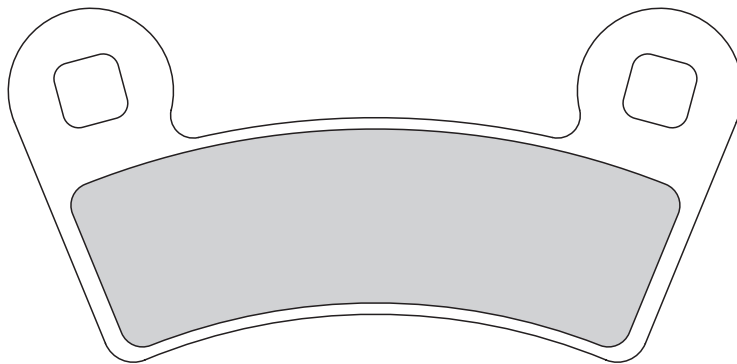

SHOES **MF**

LINES **FK**

GALFER
FD
405
G1370

↔ 90,6
mm x
↕ 62,0
↔ 13,5

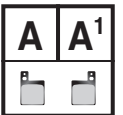
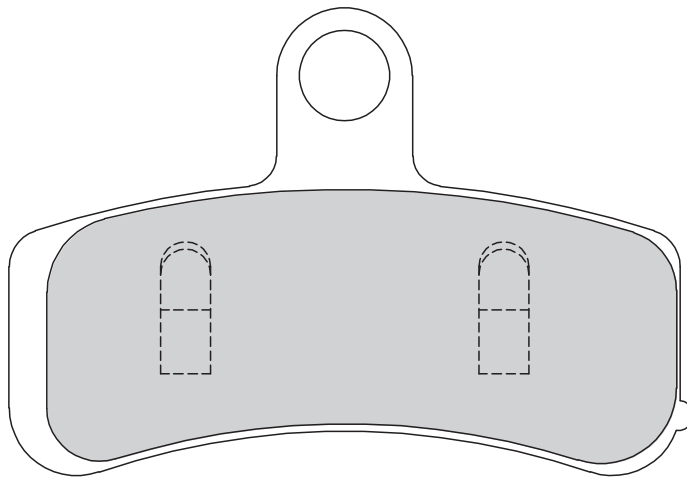

BRACKETS **SP**

KITS **KG**

GALFER
FD
406
G1371

↔ 130,0
mm x
↕ 56,5
↔ 7,4

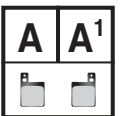
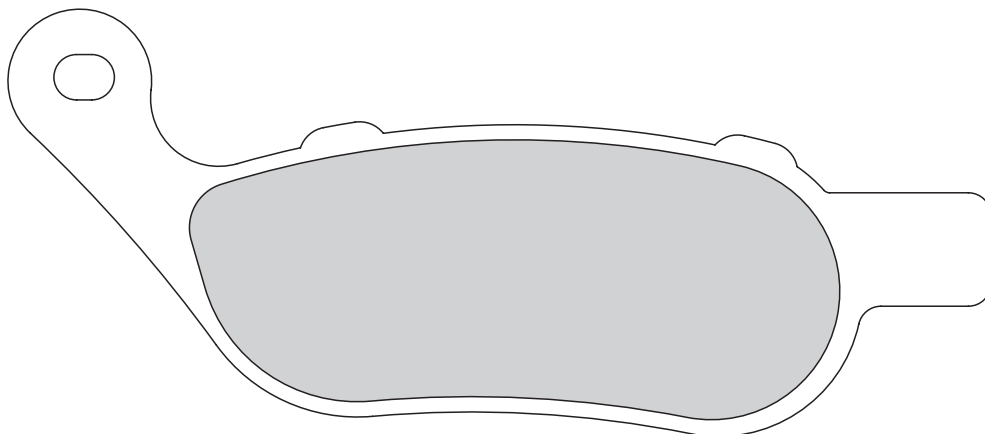

CROSS REFERENCE

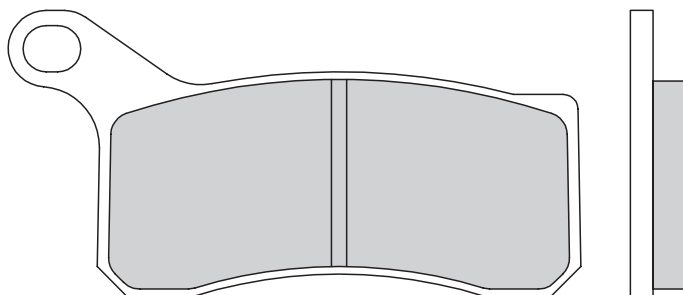
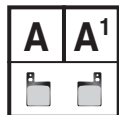

GALFER
FD
407
G1397

76,5
mm x
38,2
7,5

APPLICATIONS

PADS **FD**

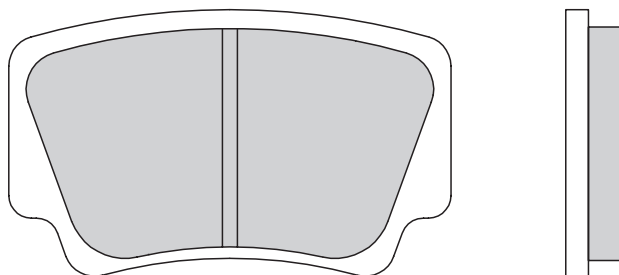
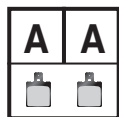

GALFER
FD
408
G1397

58,7
mm x
35,4
8,4

DISCS **DF**

SHOES **MF**

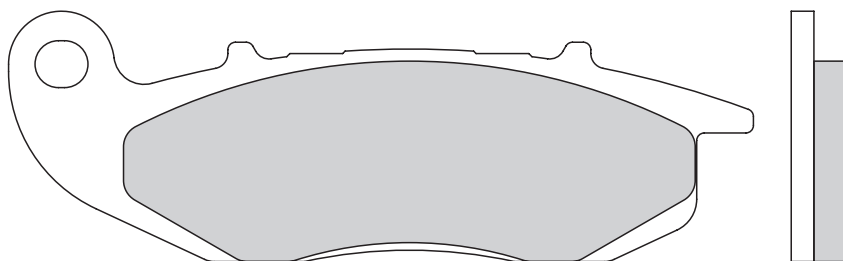
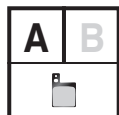

GALFER
FD
409
G1054
G1396

98,5
mm x
33,1
7,6

LINES **FK**

BRACKETS **SP**

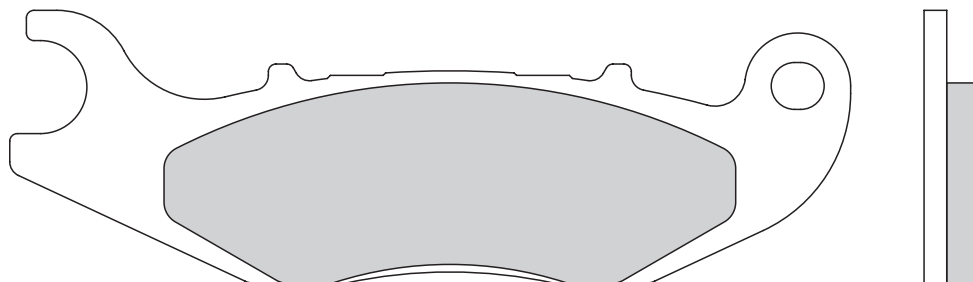
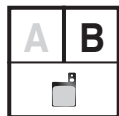

111,2
mm x
36,1
7,6

KITS **KG**

CROSS REFERENCE



APPLICATIONS

GALFER
FD
411
G1054

↔ 74,5
mm x
↕ 41,5
↔ 7,1

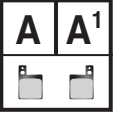
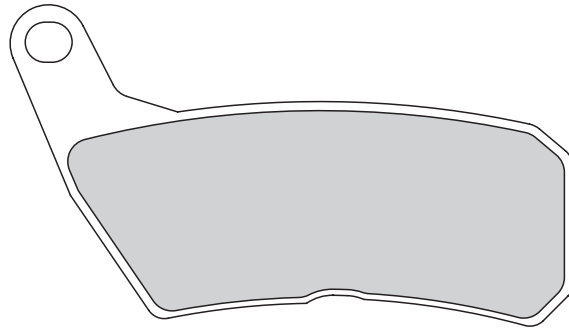

PADS **FD**

DISCS **DF**

GALFER
FD
412
G1380

↔ 70,0
mm x
↕ 42,0
↔ 8,0

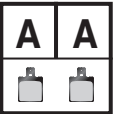
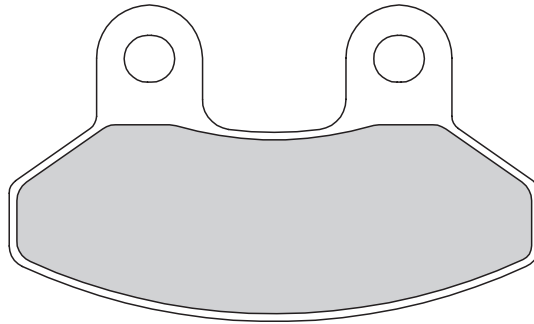

SHOES **MF**

LINES **FK**

GALFER
FD
414
G1375

↔ 78,1
mm x
↕ 46,2
↔ 7,8

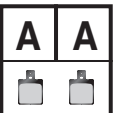
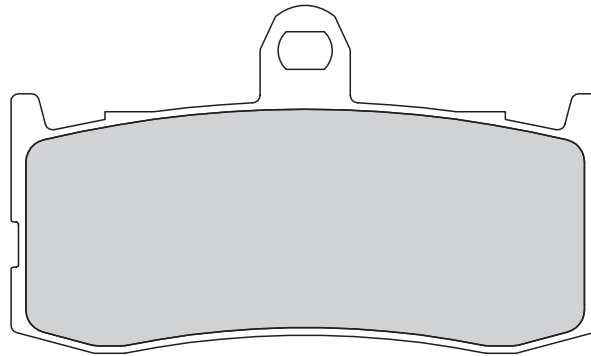

BRACKETS **SP**

KITS **KG**

GALFER
FD
428
G1805

↔ 36,0
mm x
↕ 42,0
↔ 6,0

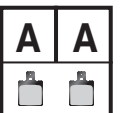
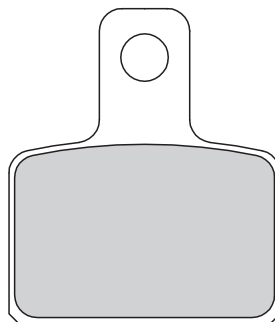

CROSS REFERENCE

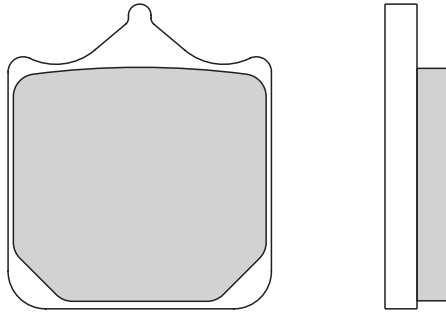

FD262 (th. 7,5mm) can replace **FD437** except for **BMW S 1000 RR** (not vice versa) | **FD262** (th. 7,5mm) puede sustituir **FD437** excepto para la **BMW S 1000 RR** (no al revés)

GALFER
FD
437
G1375
G1375R

35,0
x
40,5
mm

9,0

APPLICATIONS

PADS

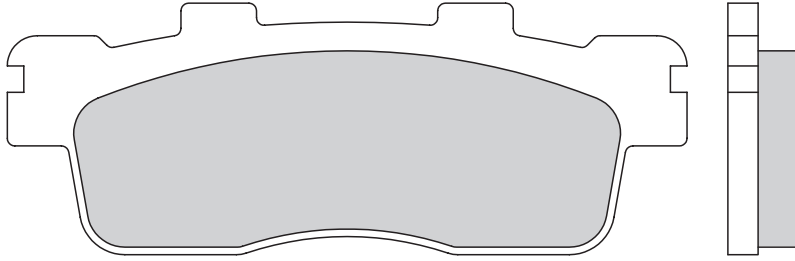
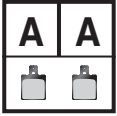

GALFER
FD
438
G1054
G1050
G1380

90,0
x
33,3
mm

9,8

DISCS

SHOES

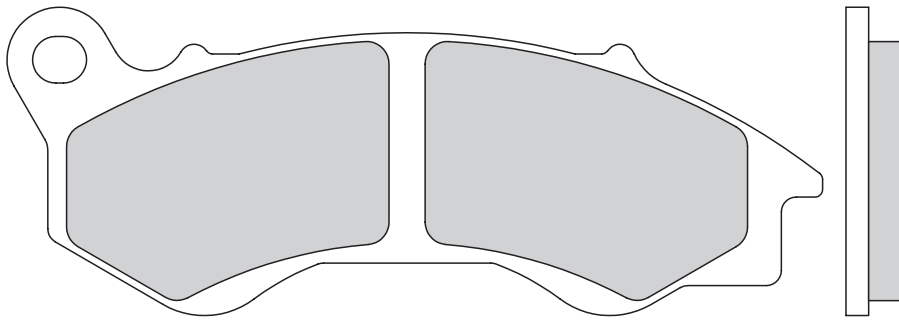

GALFER
FD
439
G1054
G1050
G1380

108,6
x
41,0
mm

8,0

LINES

BRACKETS

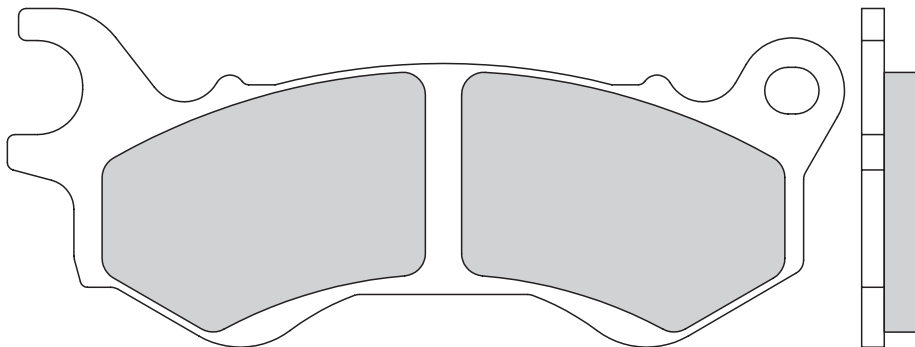
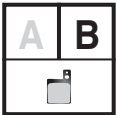

111,2
x
45,0
mm

8,0

KITS

CROSS REFERENCE



APPLICATIONS

GALFER
FD
441
G1396
G1396R

PADS **FD**

↔ 41,0
mm x
↕ 42,3
↔ 7,3

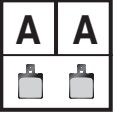
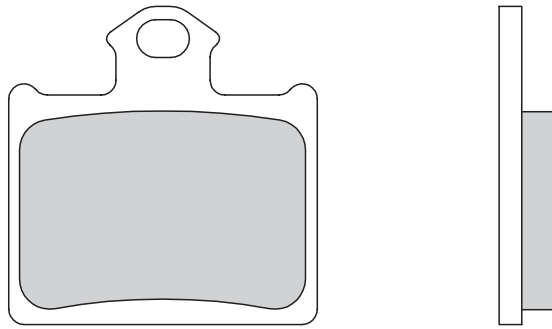

DISCS **DF**

GALFER
FD
442
G1375

SHOES **MF**

↔ 69,0
mm x
↕ 51,4
↔ 9,0

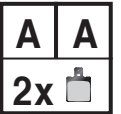
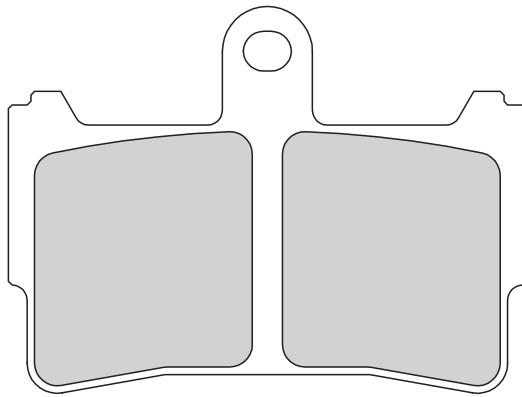

LINES **FK**

↔ 33,0
mm x
↕ 51,7
↔ 9,0

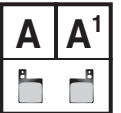
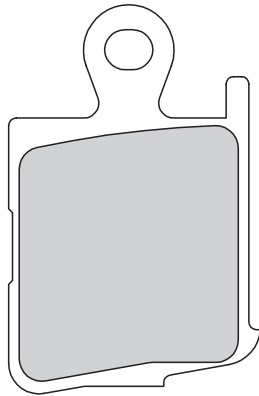

BRACKETS **SP**

KITS **KG**

GALFER
FD
443
G1371

CROSS REFERENCE

↔ 99,4
mm x
↕ 38,0
↔ 9,0

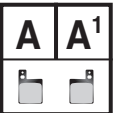
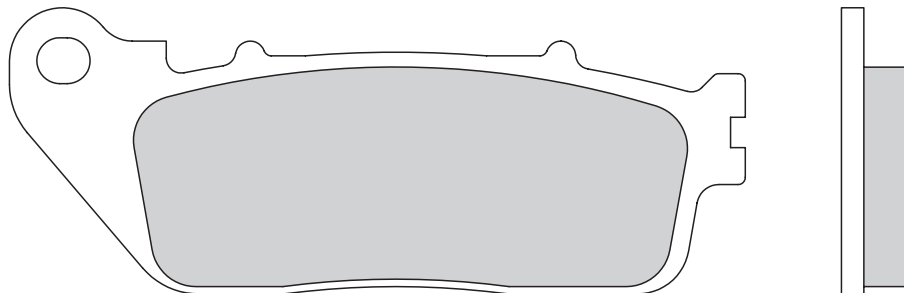

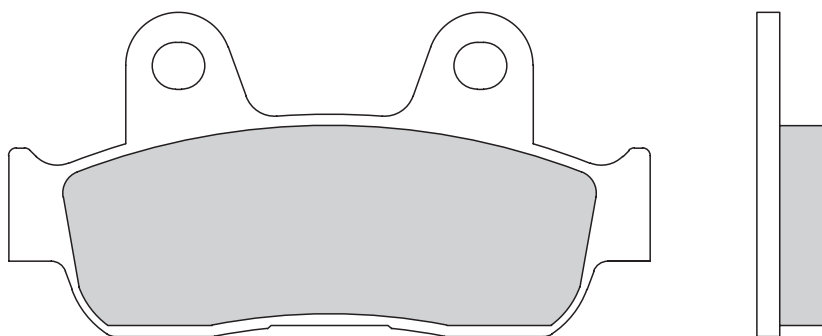
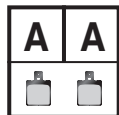

GALFER
FD
444
G1383

85,0
mm x
43,0
9,5

APPLICATIONS

PADS **FD**

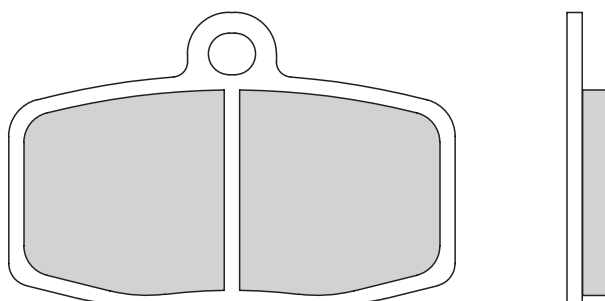
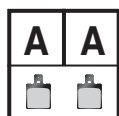

GALFER
FD
446
G1054
G1805
G1370

59,0
mm x
38,5
5,8

DISCS **DF**

SHOES **MF**

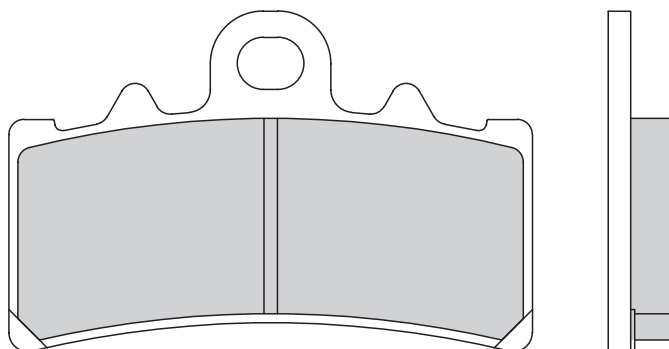
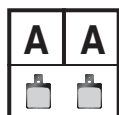

GALFER
FD
450
G1054
G1370
G1375
G1375R

69,5
mm x
45,2
8,8

LINES **FK**

BRACKETS **SP**

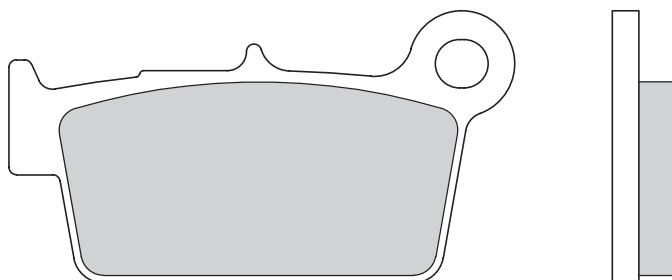
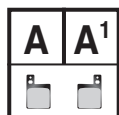

GALFER
FD
456
G1054
G1396
G1396R

66,9
mm x
36,0
9,0

KITS **KG**

CROSS REFERENCE



APPLICATIONS

GALFER
FD
457
G1054
G1371

86,2
x
40,2
mm
9,0

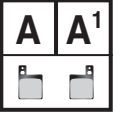
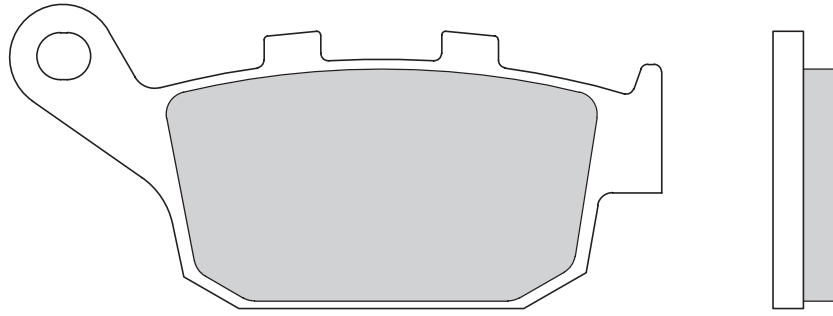

PADS **FD**

DISCS **DF**

GALFER
FD
458
G1054
G1396
G1396R

59,0
x
38,5
mm
7,3

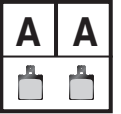
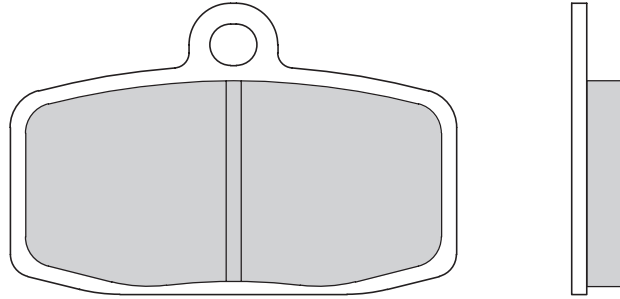

SHOES **MF**

FD446 (th. 5,8mm) can replace **FD458** (not vice versa) | **FD446** (th. 5,8mm) puede sustituir **FD458** (no al revés)

LINES **FK**

GALFER
FD
460
G1054
G1805

56,0
x
31,8
mm
5,0

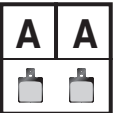
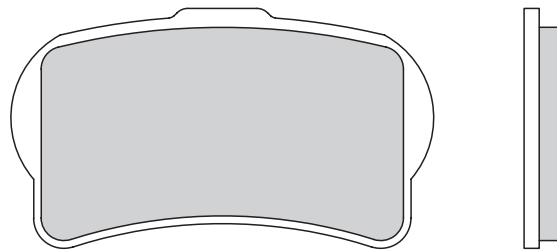

BRACKETS **SP**

KITS **KG**

GALFER
FD
473
G1054
G1380

109,0
x
50,5
mm
9,5

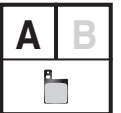
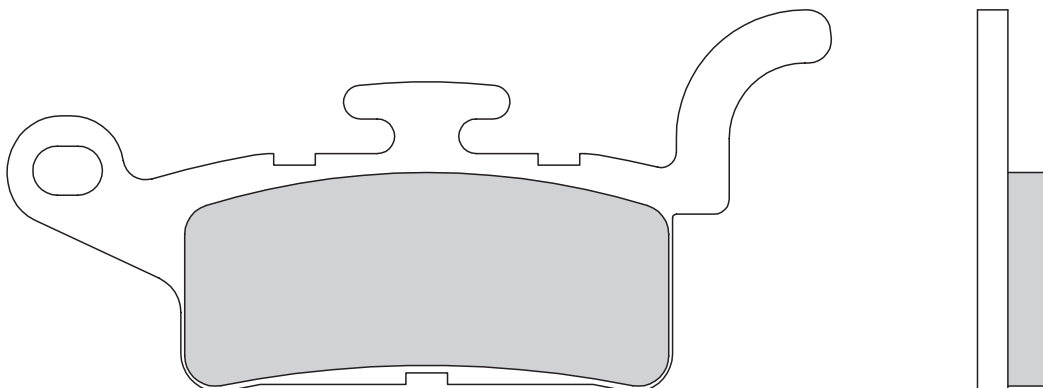

CROSS REFERENCE

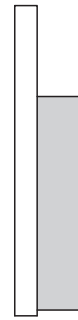
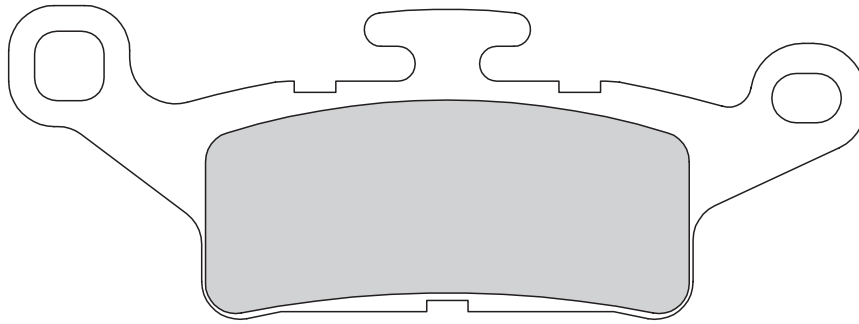
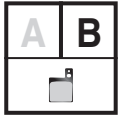

↔	113,5
mm	x
↑↓	41,0
↔	9,0

APPLICATIONS

PADS FD

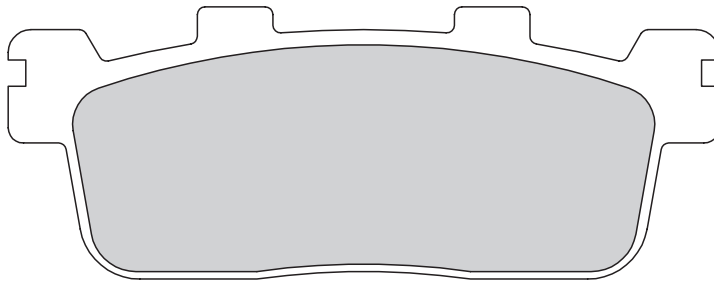
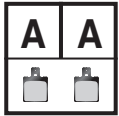

GALFER
FD
474
G1054
G1380

↔	94,0
mm	x
↑↓	36,0
↔	10,5

DISCS DF

SHOES MF

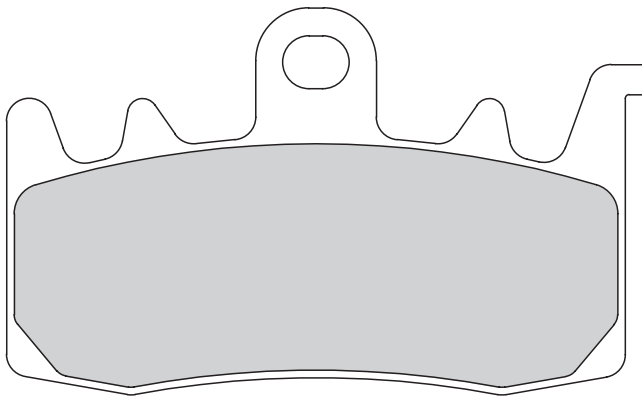
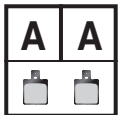

GALFER
FD
475
G1054
G1370
G1375
G1375R

↔	84,9
mm	x
↑↓	51,3
↔	8,0

LINES FK

BRACKETS SP

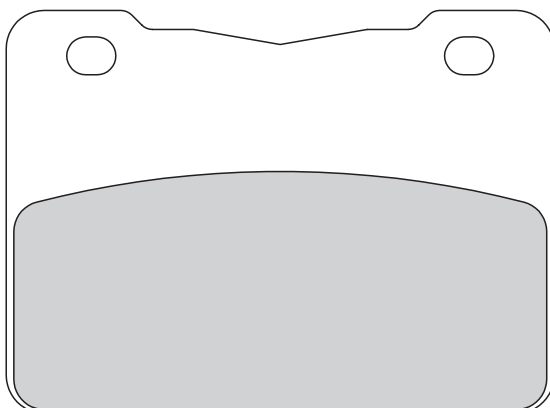
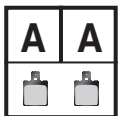

GALFER
FD
481
G1380

↔	72,5
mm	x
↑↓	53,3
↔	8,0

CROSS REFERENCE

KITS KG



APPLICATIONS

GALFER
FD
483
G1380

PADS **FD**

83,0
x
48,5
12,0

DISCS **DF**

83,0
x
48,5
12,0

SHOES **MF**

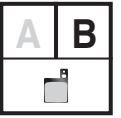
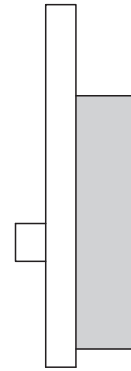
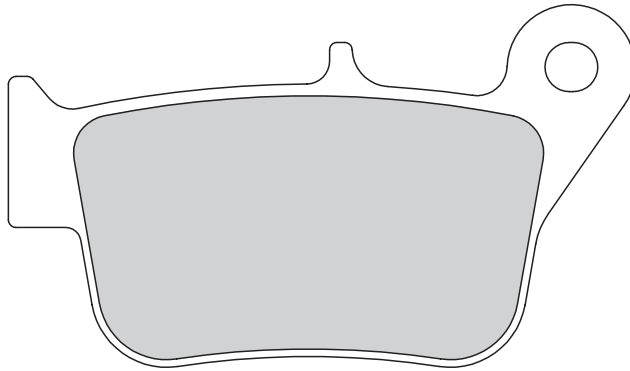
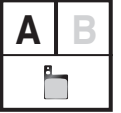
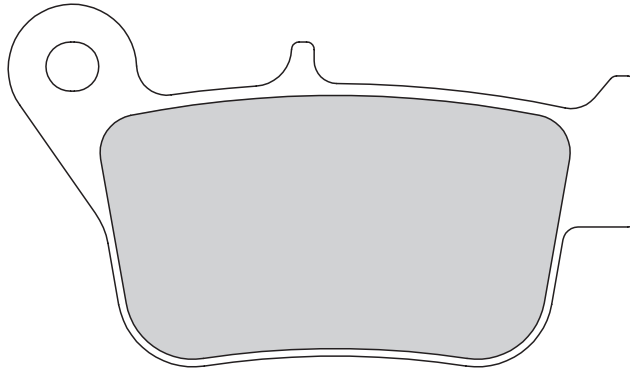

LINES **FK**

GALFER
FD
484
G1370

BRACKETS **SP**

97,0
x
39,7
11,5

KITS **KG**

113,0
x
52,8
11,5

CROSS REFERENCE

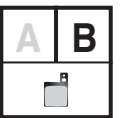
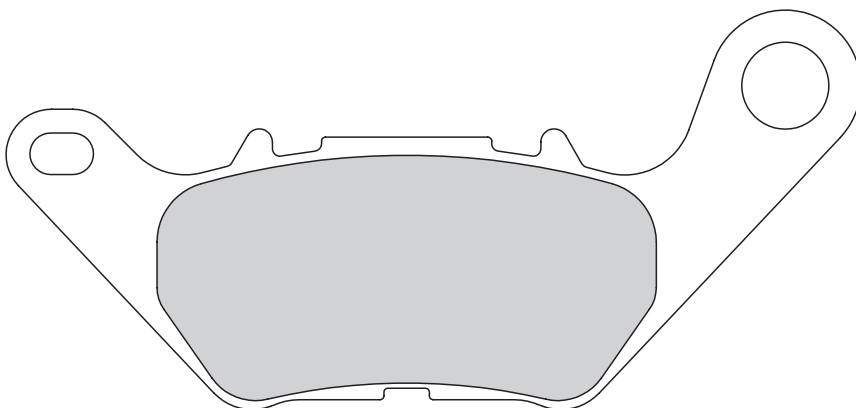
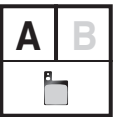
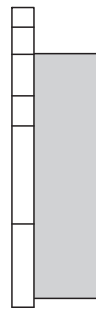
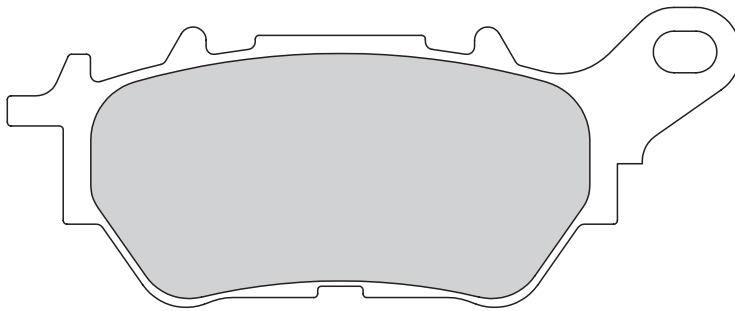

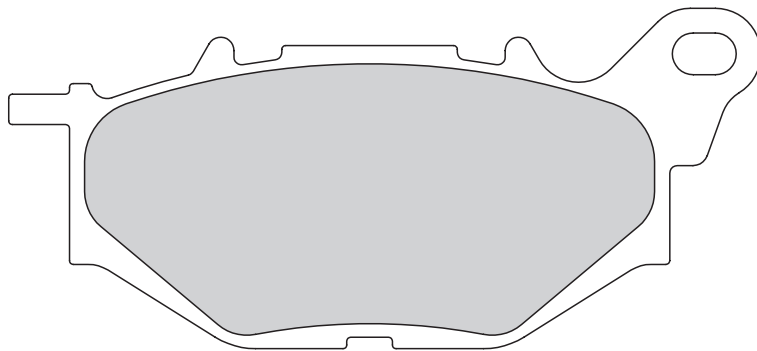
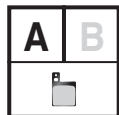

GALFER
FD
485
G1370
G1375R

99,0
x
44,8
mm

8,5

113,3
x
54,9
mm

8,5

APPLICATIONS

PADS **FD**

DISCS **DF**

SHOES **MF**

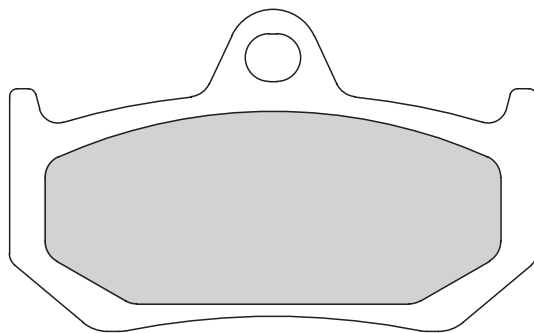
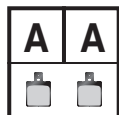
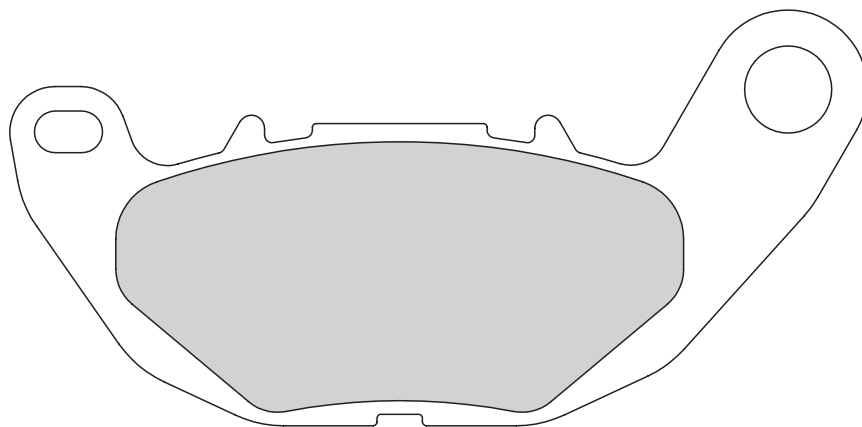
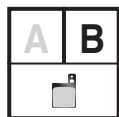

GALFER
FD
486
G1371

69,7
x
42,6
mm

7,3

LINES **FK**

BRACKETS **SP**

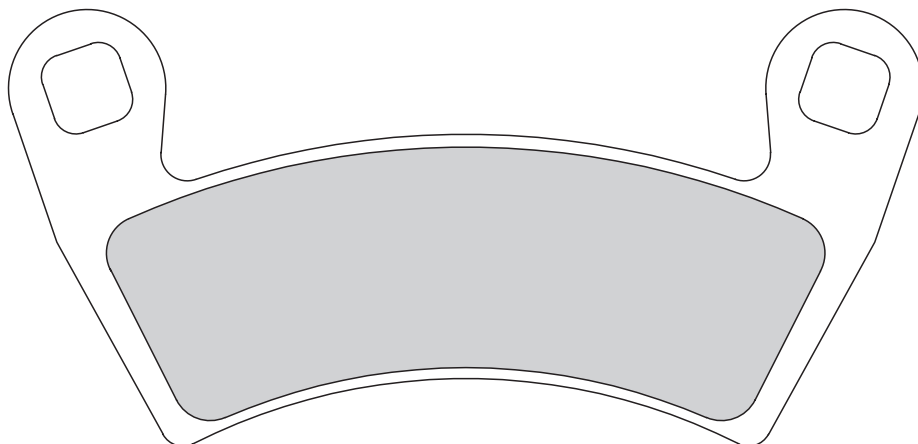
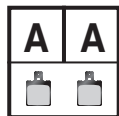

GALFER
FD
491
G1397

121,3
x
57,9
mm

7,4

KITS **KG**

CROSS REFERENCE



APPLICATIONS

GALFER
FD
492
G1380

↔ 74,5
mm x
↕ 41,0

↔ 8,8

↔ 85,3
mm x
↕ 44,5

↔ 8,8

PADS **FD**

DISCS **DF**

SHOES **MF**

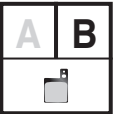
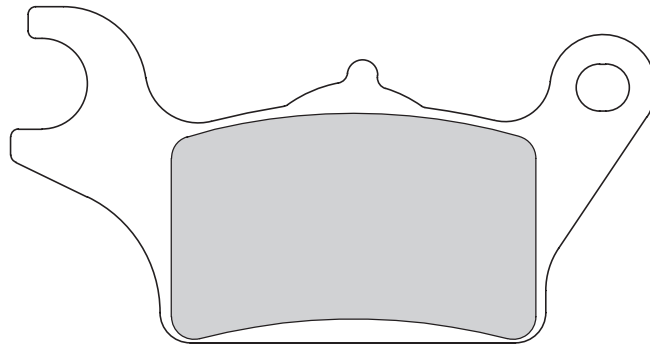
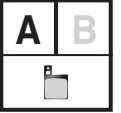
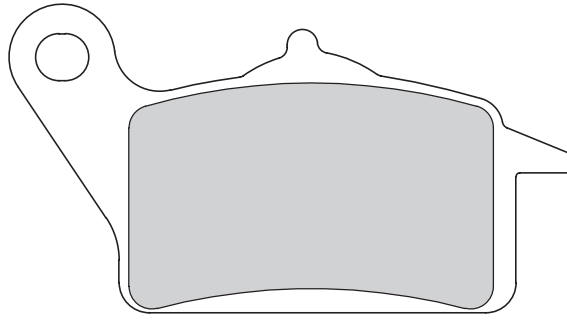

FD540 (th. 6,9mm) can replace FD492 (not vice versa) | FD540 (th. 6,9mm) puede sustituir FD492 (no al revés)

LINES **FK**

GALFER
FD
493
G1380

↔ 85,3
mm x
↕ 44,5

↔ 8,8

↔ 74,5
mm x
↕ 41,0

↔ 8,8

BRACKETS **SP**

KITS **KG**

CROSS REFERENCE

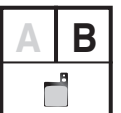
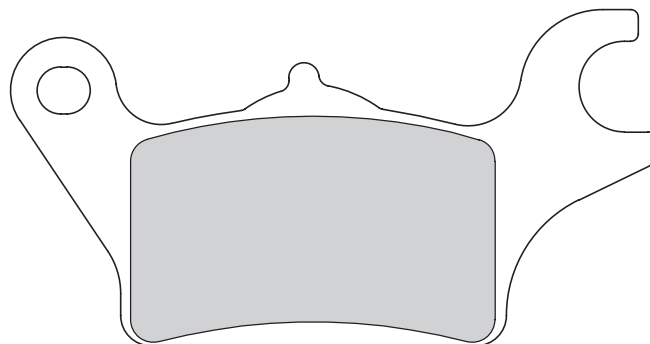
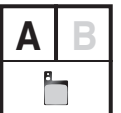
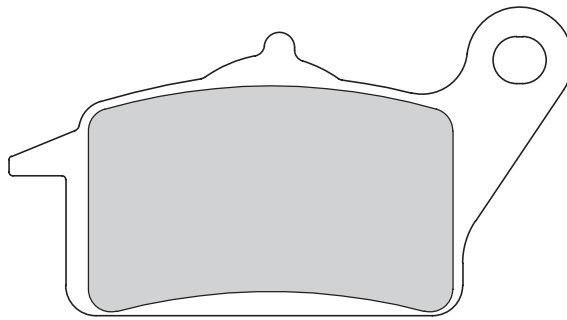

FD504 (th. 6,9mm) can replace FD493 (not vice versa) | FD504 (th. 6,9mm) puede sustituir FD493 (no al revés)

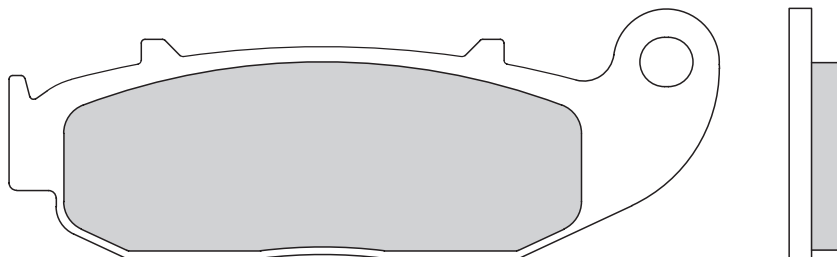
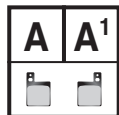

GALFER
FD
497
G1054

↔ 94,0
mm x
↑↓ 33,0
↔ 8,0

APPLICATIONS

PADS **FD**

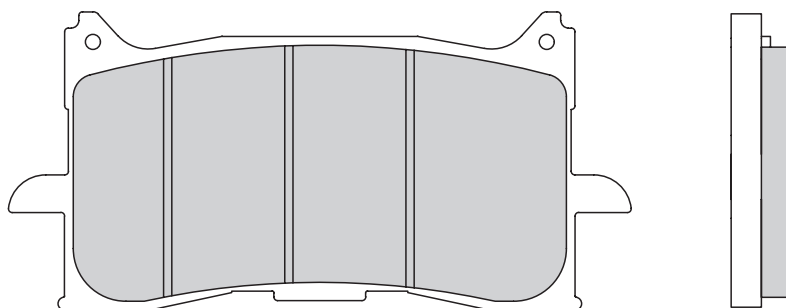
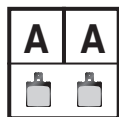

GALFER
FD
499
G1370
G1375R

↔ 82,7
mm x
↑↓ 39,6
↔ 7,9

DISCS **DF**

SHOES **MF**

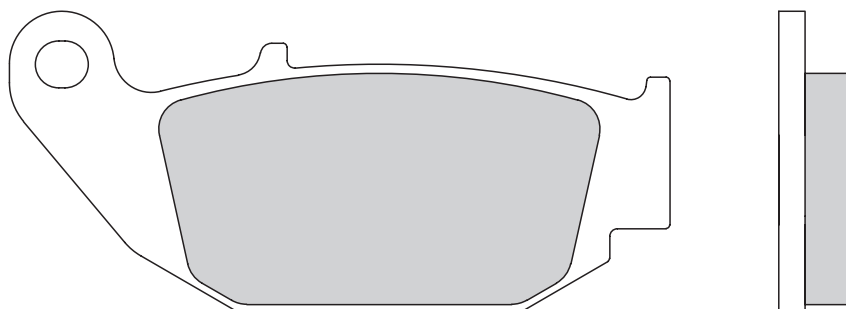
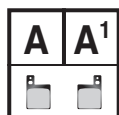

GALFER
FD
500
G1370

↔ 88,0
mm x
↑↓ 40,0
↔ 10,0

LINES **FK**

BRACKETS **SP**

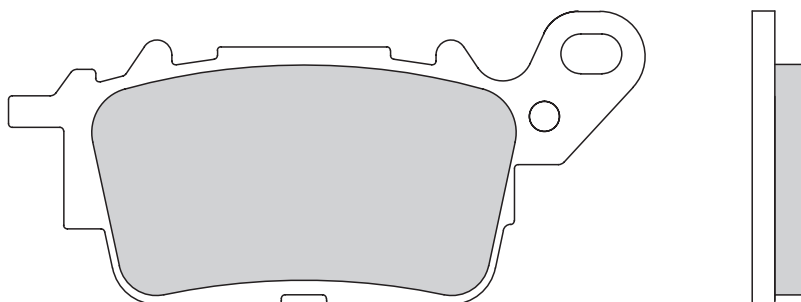
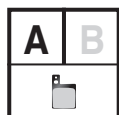

GALFER
FD
503
G1054
G1050
G1370
G1380

↔ 84,6
mm x
↑↓ 39,0
↔ 7,5

KITS **KG**

CROSS REFERENCE



APPLICATIONS

	97,6
mm	x
	49,8
	7,5

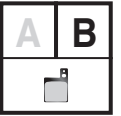
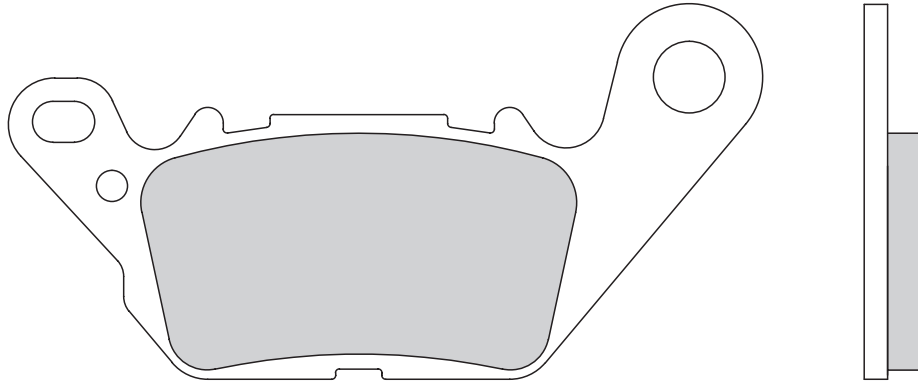

PADS **FD**

DISCS **DF**

GALFER
FD
504
G1370

	85,3
mm	x
	44,5
	6,9

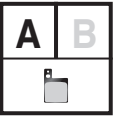
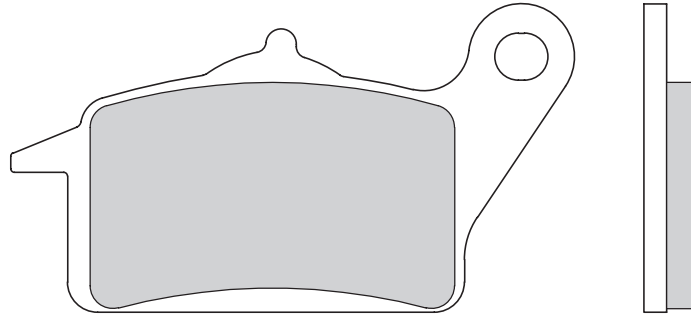

SHOES **MF**

	74,5
mm	x
	41,0
	6,9

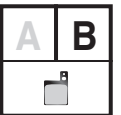
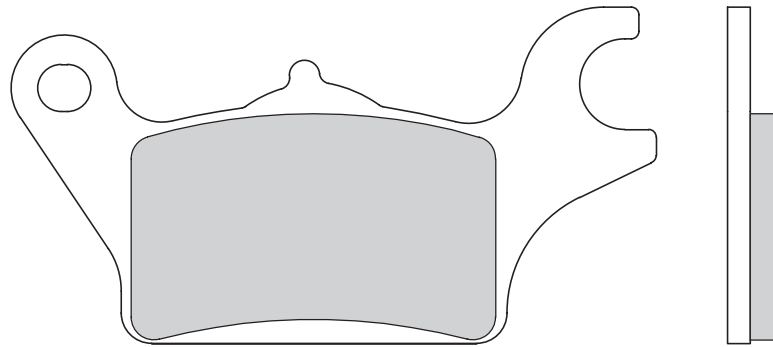

LINES **FK**

BRACKETS **SP**

KITS **KG**

CROSS REFERENCE

GALFER
FD
506
G1397

	155,0
mm	x
	52,5
	7,5

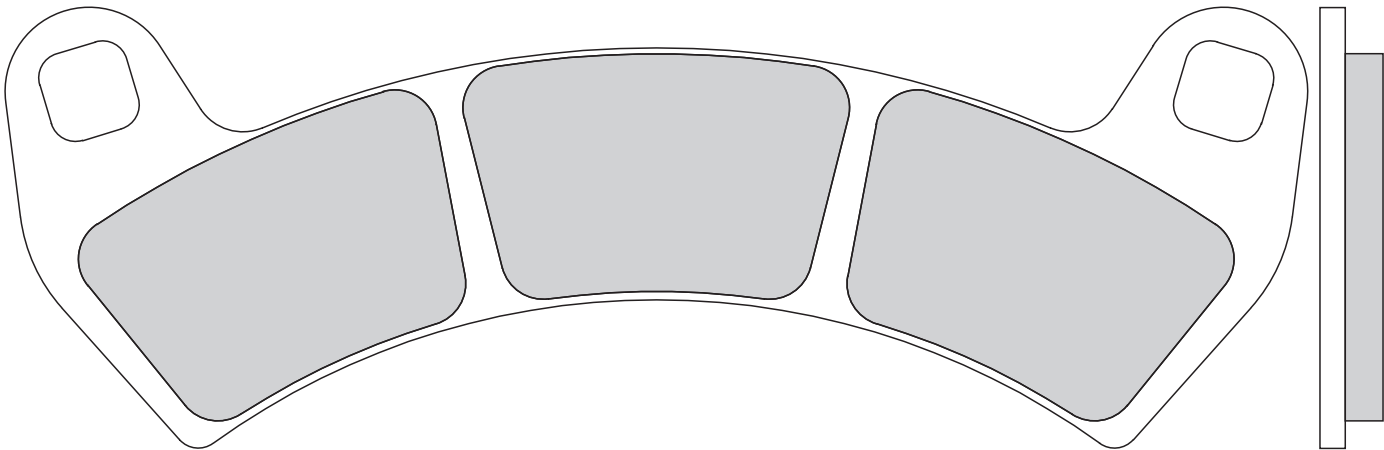

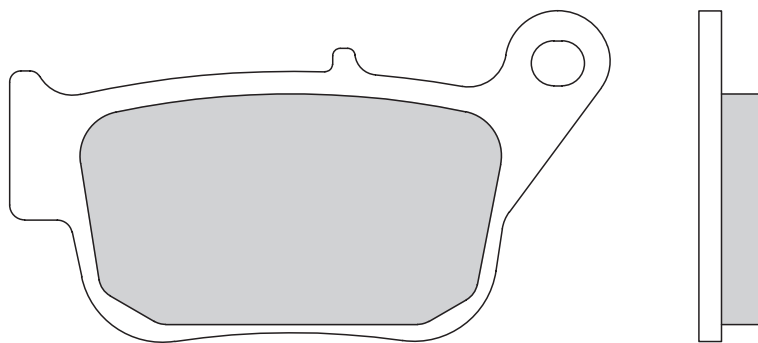
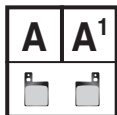

GALFER
FD
509
G1054
G1050
G1380

80,0
mm x
44,0
8,6

APPLICATIONS

PADS **FD**

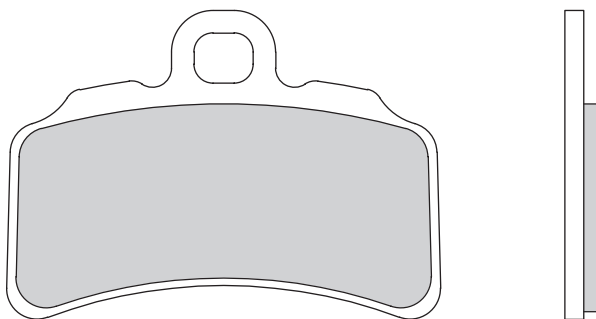
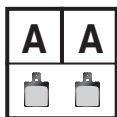

GALFER
FD
511
G1805

57,4
mm x
40,8
5,0

DISCS **DF**

SHOES **MF**

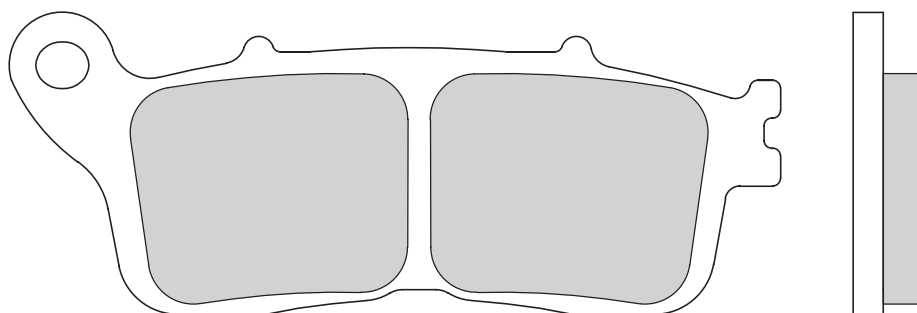
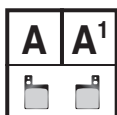

GALFER
FD
512
G1370

102,0
mm x
40,0
9,4

LINES **FK**

BRACKETS **SP**

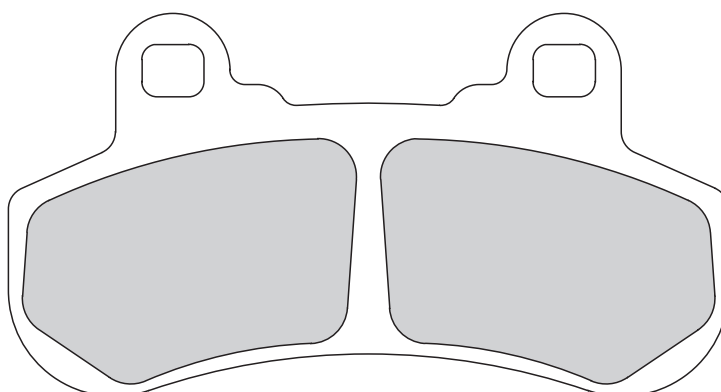
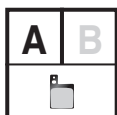

GALFER
FD
514
G1397

95,2
mm x
50,6
8,0

KITS **KG**

CROSS REFERENCE



APPLICATIONS

	118,0
	x
	50,5
	8,0

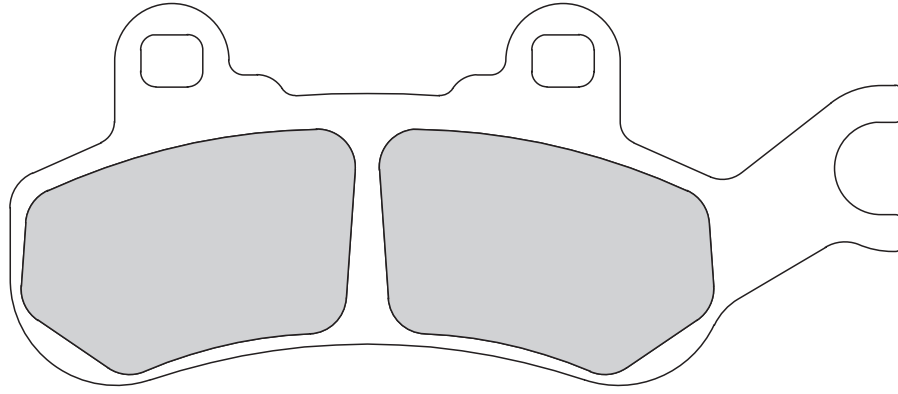
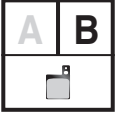

PADS **FD**

DISCS **DF**

GALFER
FD
515
G1397

	118,0
	x
	50,5
	8,0

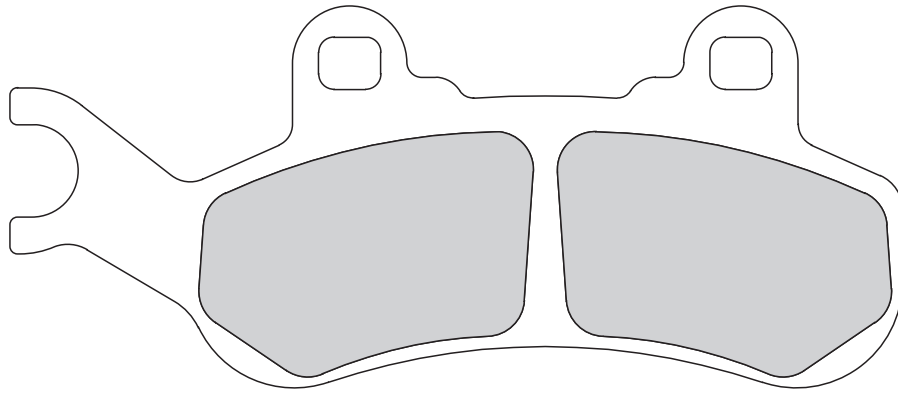
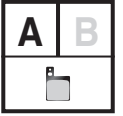

SHOES **MF**

LINES **FK**

	95,2
	x
	50,6
	8,0

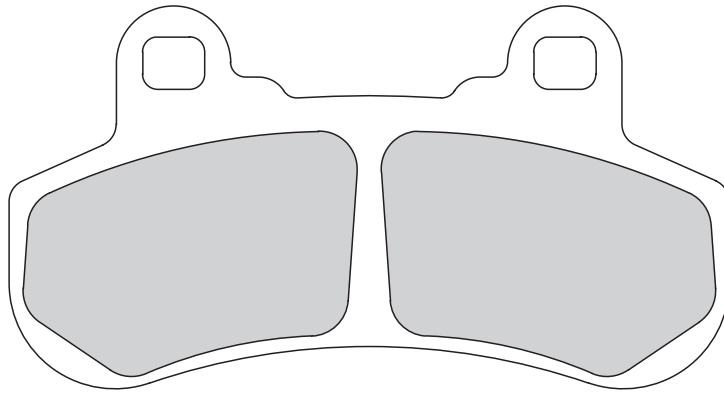
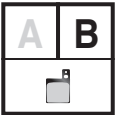

BRACKETS **SP**

KITS **KG**

GALFER
FD
517
G1397

	113,8
	x
	36,7
	8,8

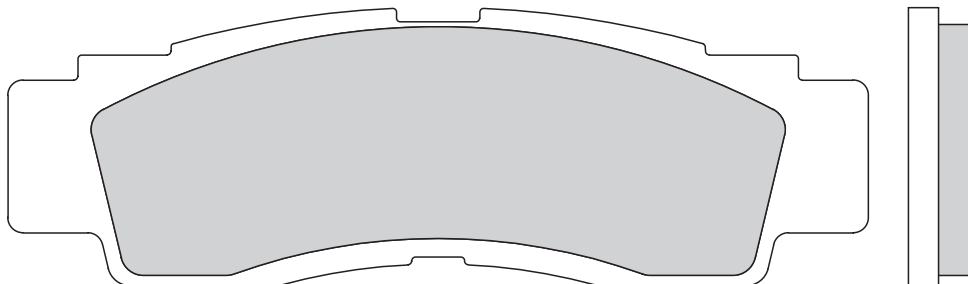
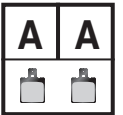

CROSS REFERENCE

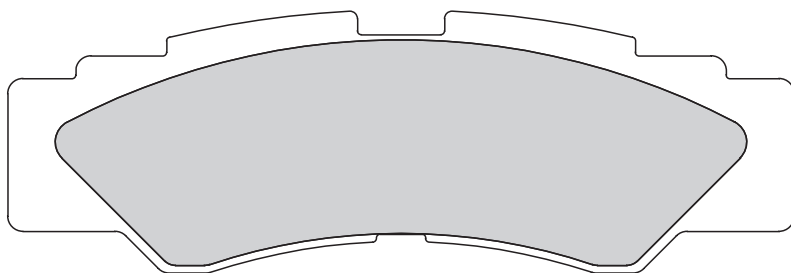
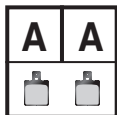

GALFER
FD
518
G1397

104,0
mm x
34,6
8,8

APPLICATIONS

PADS **FD**

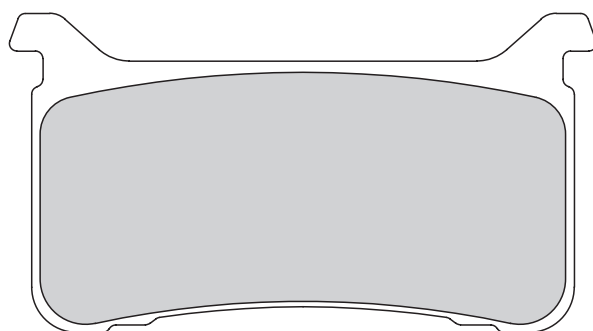
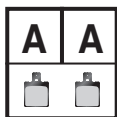

GALFER
FD
519
G1375
G1375R

77,9
mm x
42,3
7,8

DISCS **DF**

SHOES **MF**

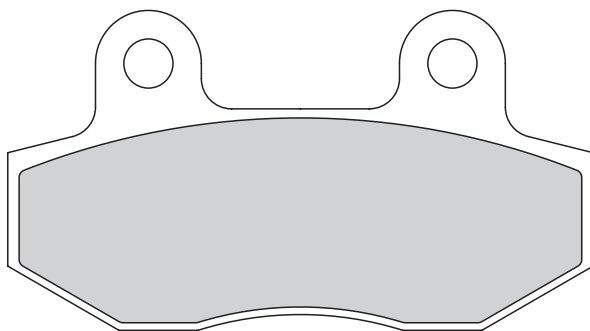
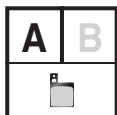

GALFER
FD
524
G1380

77,4
mm x
42,3
9,2

LINES **FK**

BRACKETS **SP**

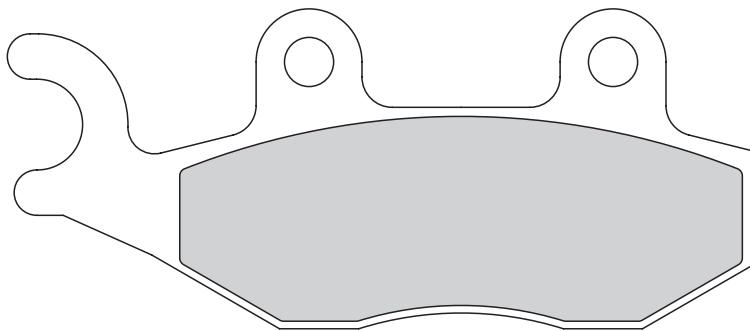
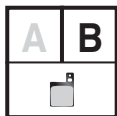

96,8
mm x
42,3
9,2

KITS **KG**

CROSS REFERENCE

FD086 (th. 7,5mm) or FD187 (th. 8,5mm) can replace FD524 (not vice versa) | FD086 (th. 7,5mm) o FD187 (th. 8,5mm) puede sustituir FD524 (no al revés)



APPLICATIONS

GALFER
FD
526
G1370

85,6
x
37,6
mm
8,9

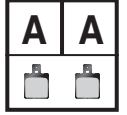
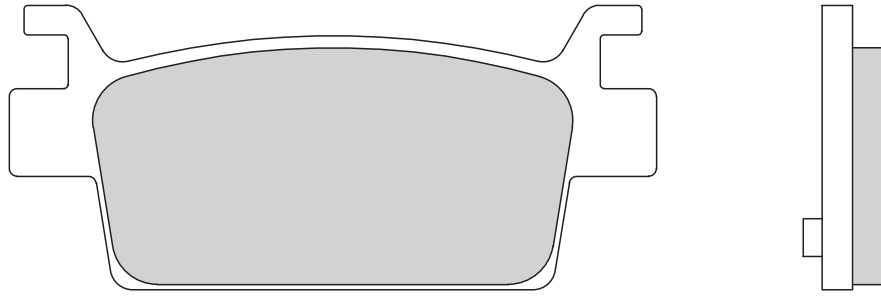

PADS **FD**

DISCS **DF**

GALFER
FD
532
G1370
G1375R

77,4
x
42,3
mm
8,4

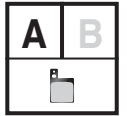
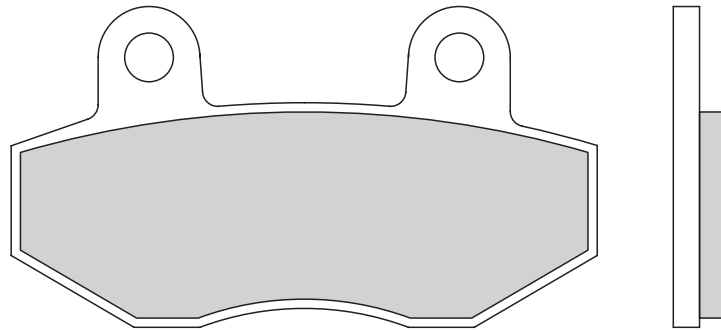

SHOES **MF**

LINES **FK**

96,8
x
42,3
mm
8,5

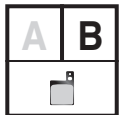
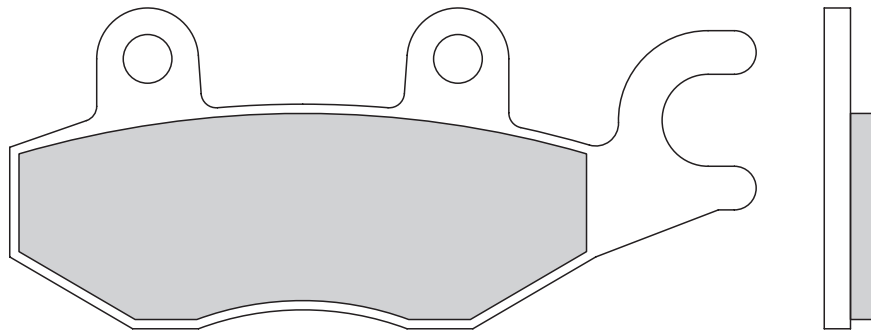

BRACKETS **SP**

KITS **KG**

GALFER
FD
533
G1054

108,6
x
41,0
mm
8,0

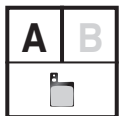
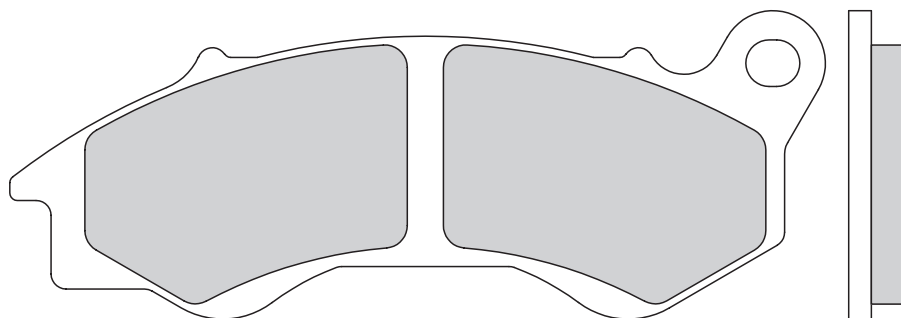

CROSS REFERENCE

FD117 (th. 7,7mm) can replace FD532 (not vice versa) | FD117 (th. 7,7mm) puede sustituir FD532 (no al revés)

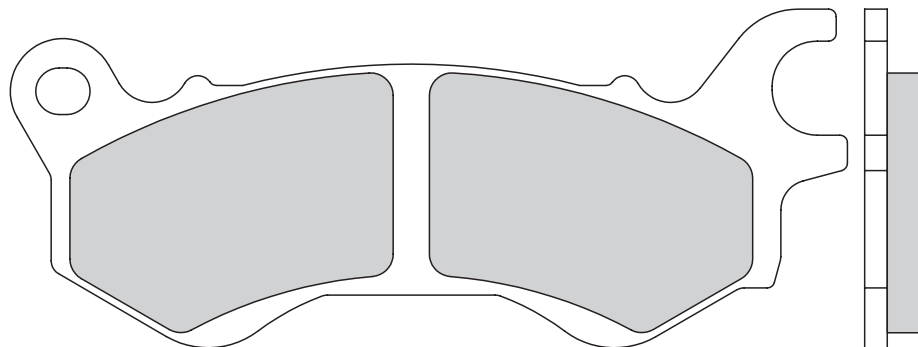
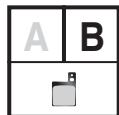

↔	111,2
mm	x
↕	45,0
⏏	8,0

APPLICATIONS

PADS FD

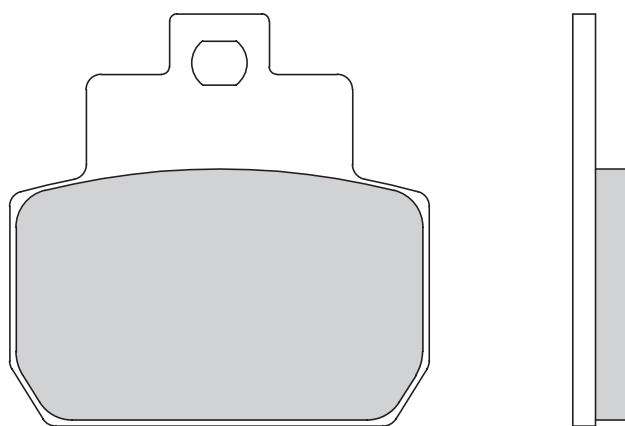
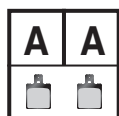

GALFER
FD
536
G1371

↔	55,5
mm	x
↕	54,5
⏏	7,8

DISCS DF

SHOES MF

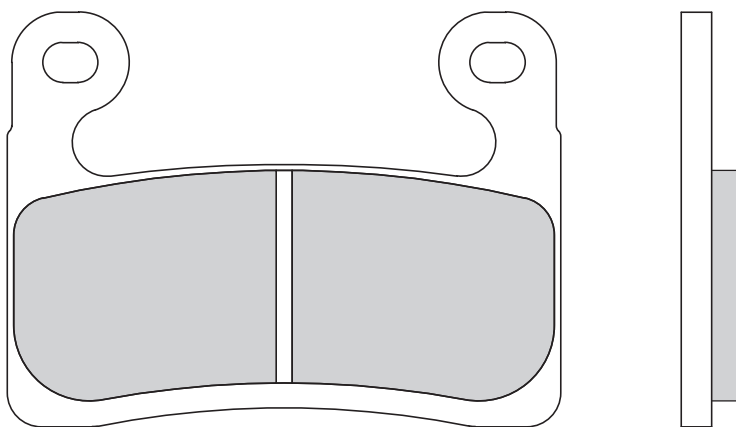
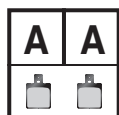

GALFER
FD
537
G1375
G1375R

↔	73,2
mm	x
↕	54,8
⏏	8,3

LINES FK

BRACKETS SP

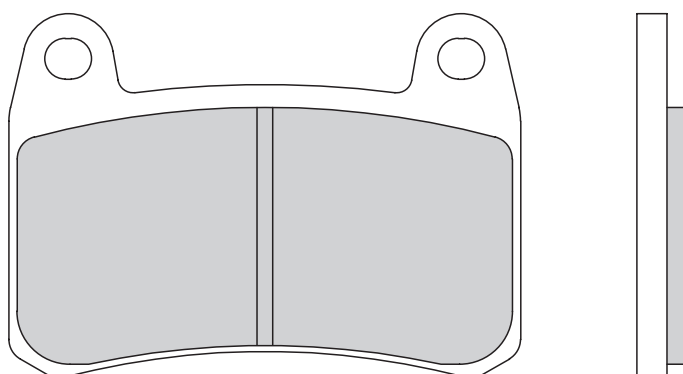
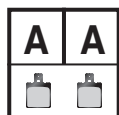

GALFER
FD
538
G1370
G1375R

↔	67,7
mm	x
↕	48,2
⏏	7,1

KITS KG

CROSS REFERENCE



APPLICATIONS

GALFER
FD
540
G1380

↔ 74,5
mm x
↕ 41,0
↔ 7,0

↔ 85,3
mm x
↕ 44,5
↔ 6,9

PADS **FD**

DISCS **DF**

SHOES **MF**

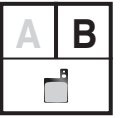
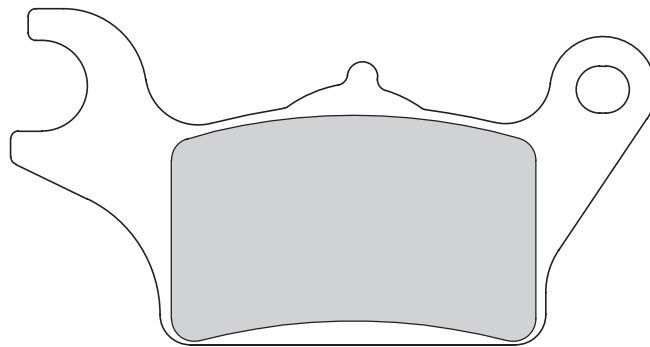
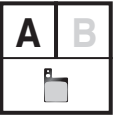
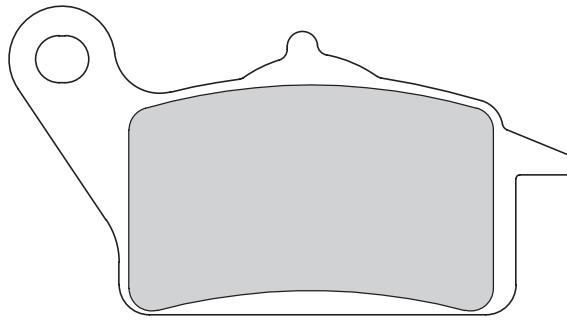

LINES **FK**

GALFER
FD
541
G1380

↔ 117,5
mm x
↕ 40,0
↔ 8,5

BRACKETS **SP**

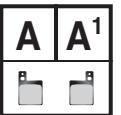
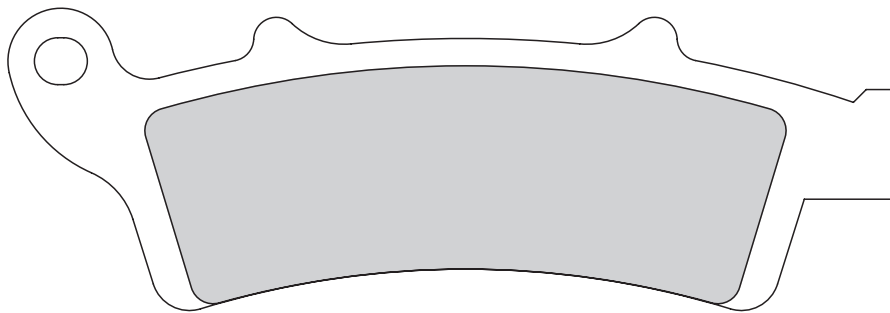

KITS **KG**

GALFER
FD
542
G1370

↔ 81,9
mm x
↕ 42,1
↔ 9,9

CROSS REFERENCE

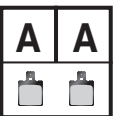
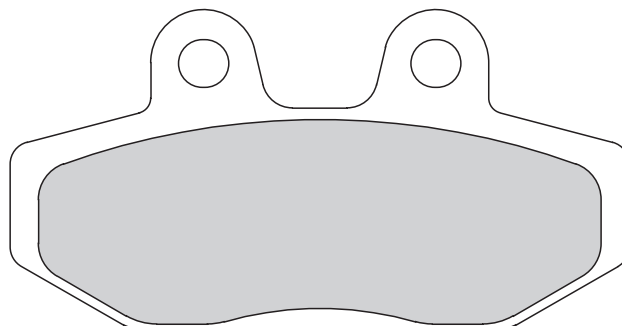

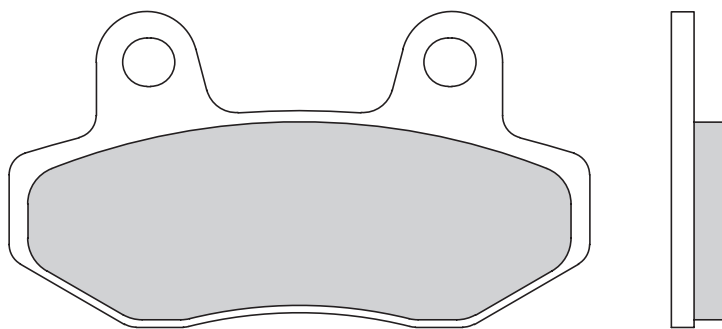
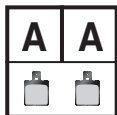

GALFER
FD
544
G1370

76,9
mm x
41,8

7,0

APPLICATIONS

PADS FD

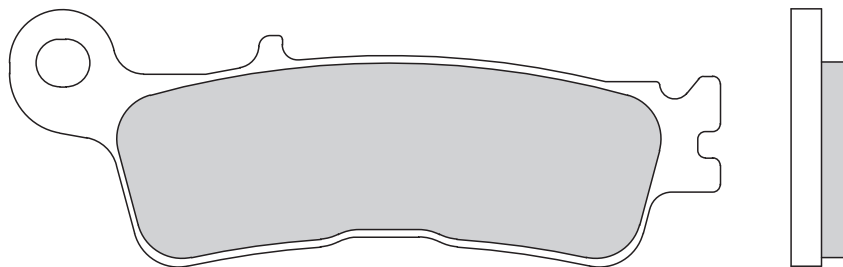
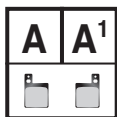

GALFER
FD
545
G1396
G1396R

94,0
mm x
34,0

7,5

DISCS DF

SHOES MF

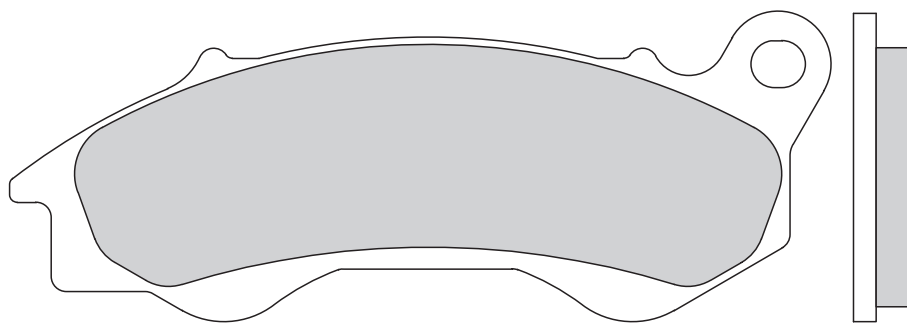
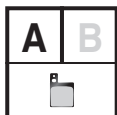

GALFER
FD
546
G1380

108,6
mm x
41,0

8,0

LINES FK

BRACKETS SP

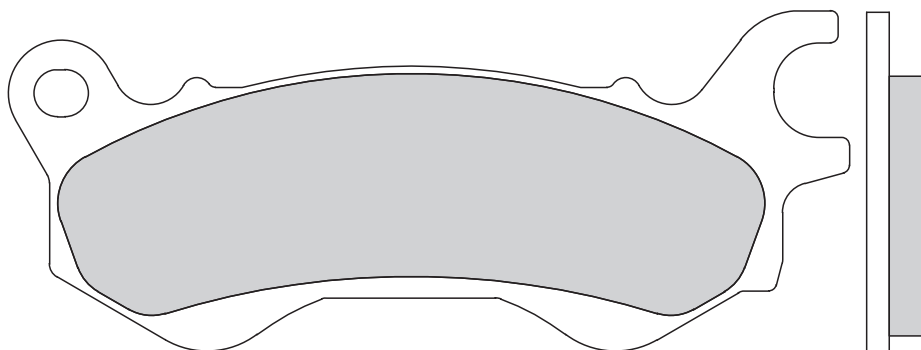
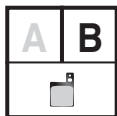

111,2
mm x
45,0

8,0

KITS KG

CROSS REFERENCE



APPLICATIONS

GALFER
FD
547
G1380

↔ 108,6
mm x
↕ 41,0
↔ 8,0

↔ 111,2
mm x
↕ 45,0
↔ 8,0

PADS **FD**

DISCS **DF**

SHOES **MF**

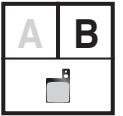
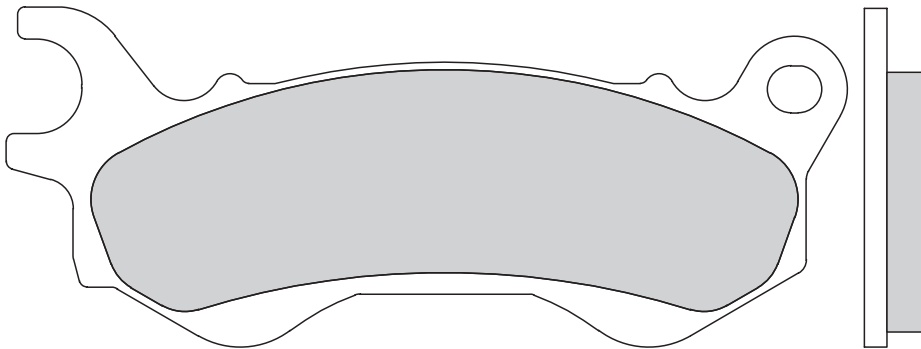
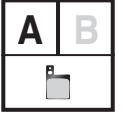
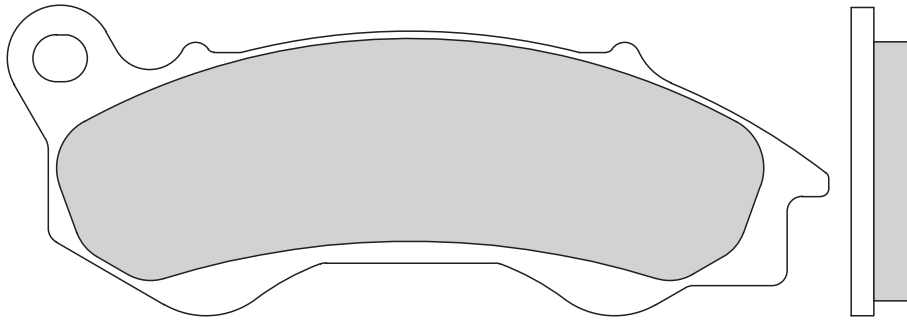

LINES **FK**

GALFER
FD
548
G1380

↔ 77,4
mm x
↕ 42,3
↔ 8,9

↔ 96,8
mm x
↕ 42,3
↔ 8,9

BRACKETS **SP**

KITS **KG**

CROSS REFERENCE

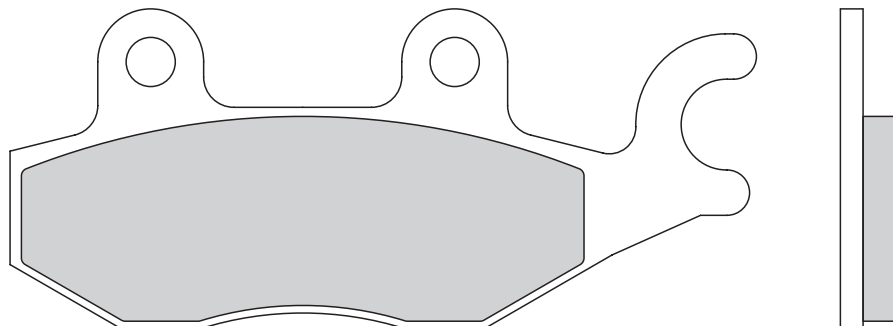
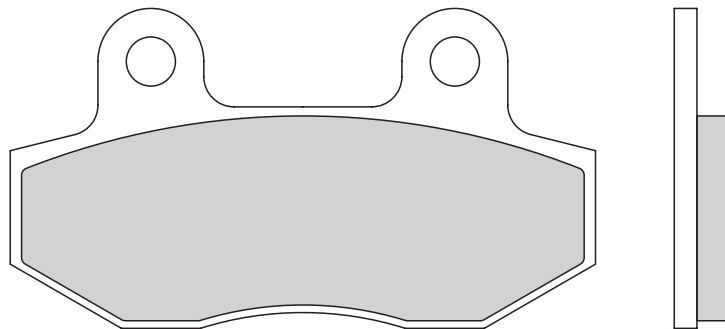



BRAKE DISCS
DISCOS DE FRENO

DISCHI FRENO
DISQUES DE FREIN

Classic

Disc wave[®]

SKULL

CUBIQ[®]



APPLICATIONS

PADS FD

DISCS DF

SHOES MF

LINES FK

BRACKETS SP

KITS KG

CROSS REFERENCE

GALFER
DF
003
W

OE

	220 mm
	122
	4,0



419 gr

GALFER
DF
007
WS

	280 mm
	105
	4,0
	SP035

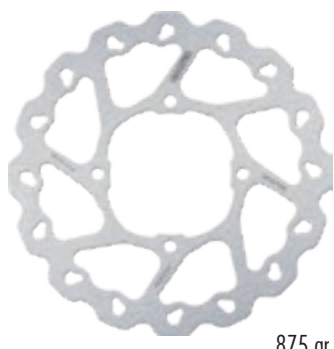

875 gr

GALFER
DF
013
W

OE

	220 mm
	105
	5,0



678 gr

GALFER
DF
004
W

OE

	256 mm
	144
	4,0



592 gr

DF073W can replace DF004W in case of TRANSALP applications

GALFER
DF
009
W

OE

	296 mm
	144
	5,0



1.257 gr

GALFER
DF
013
Q

	220 mm
	105
	5,0

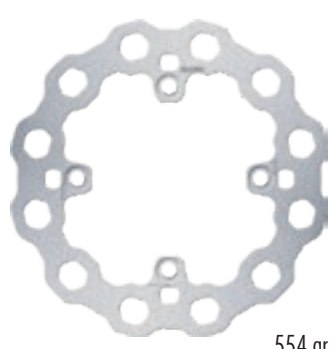

554 gr

GALFER
DF
005
W

OE

	276 mm
	144
	5,0



960 gr

GALFER
DF
010
W

OE

	220 mm
	105
	4,0



534 gr

GALFER
DF
013
WA

OE

	220 mm
	105
	5,0



698 gr

GALFER
DF
006
W

OE

	296 mm
	144
	4,0



860 gr

GALFER
DF
011
W

OE

	220 mm
	122
	4,0



525 gr

GALFER
DF
013
QA

	220 mm
	105
	5,0



569 gr

GALFER
DF
007
W

OE

	240 mm
	105
	4,0



592 gr

GALFER
DF
012
CW

OE

	296 mm
	58
	4,0
	17,0

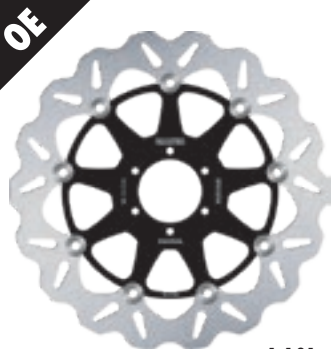

1.181 gr

GALFER
DF
014
W





OE





	240 mm
	101
	3,0





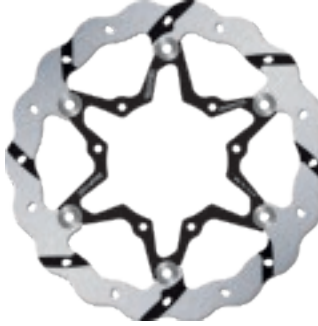





480 gr











GALFER	DF	014	FLW	OE		øext.	240	mm
						o.int.	101	
							3,0	
								
								
						500 gr		





GALFER	DF	014	FRS	OE		øext.	270	mm
						o.int.	101	
							3,0	
								
								
						552 gr		
						SP001: for CRF models until 2014 SP045: for CRF models 2015-2018 SP059: for CRF models from 2019		





GALFER	DF	020	W	OE		øext.	187	mm
						o.int.	72	
							4,0	
								
								
						380 gr		





GALFER	DF	014	RW	OE		øext.	240	mm
						o.int.	101	
							3,0	
								
								
						390 gr		





GALFER	DF	015	W	OE		øext.	220	mm
						o.int.	89	
							3,5	
								
								
						435 gr		

GALFER	DF	021	W	OE		øext.	276	mm
						o.int.	144	
							4,0	
								
								
						606 gr		





GALFER	DF	014	WS	OE		øext.	270	mm
						o.int.	101	
							3,0	
								
								
						510 gr		
						SP001: for CRF models until 2014 SP045: for CRF models 2015-2018 SP059: for CRF models from 2019		



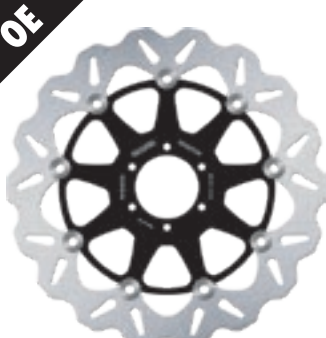

GALFER	DF	017	W	OE		øext.	240	mm
						o.int.	118	
							3,0	
								
								
						439 gr		





GALFER	DF	022	W	OE		øext.	318	mm
						o.int.	144	
							5,0	
								
								
						1.418 gr		





GALFER	DF	014	RWS	OE		øext.	270	mm
						o.int.	101	
							3,0	
								
								
						484 gr		
						SP001: for CRF models until 2014 SP045: for CRF models 2015-2018 SP059: for CRF models from 2019		

GALFER	DF	018	W	OE		øext.	158	mm
						o.int.	58	
							4,0	
								
								
						310 gr		

GALFER	DF	027	CW	OE		øext.	296	mm
						o.int.	58	
							5,0	
							17,0	
								
						1.181 gr		

GALFER	DF	014	FLS	OE		øext.	270	mm
						o.int.	101	
							3,0	
								
								
						529 gr		
						SP001: for CRF models until 2014 SP045: for CRF models 2015-2018 SP059: for CRF models from 2019		

GALFER	DF	019	W	OE		øext.	187	mm
						o.int.	88	
							4,0	
								
								
						319 gr		

GALFER	DF	028	W	OE		øext.	256	mm
						o.int.	144	
							5,0	
								
								
						818 gr		

OE: Original equipment (original replacement disc) - OE: Equipo original (disco de remplazo del original)

OE discs --> W - FLW - CW - V - FLV

Special discs --> WS - WLL - RW - RH - RWS - FLS - FLX - FRS - FRH - CRW - Q - FLQ

APPLICATIONS

PADS FD

DISCS DF

SHOES MF

LINES FK

BRACKETS SP

KITS KG

CROSS REFERENCE



APPLICATIONS

PADS FD

DISCS DF

SHOES MF

LINES FK

BRACKETS SP

KITS KG

CROSS REFERENCE

GALFER
DF
029
W

øext. 256 mm
øint. 94
3,0
5,0



893 gr

GALFER
DF
037
FLS

øext. 220 mm
øint. 58
4,0
SP008

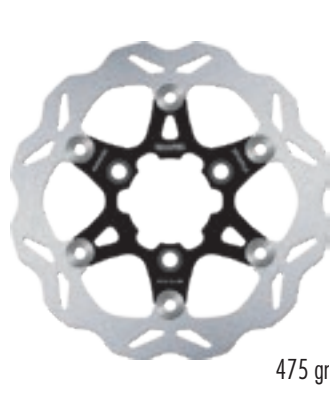

475 gr

GALFER
DF
046
W

øext. 267 mm
øint. 144
4,0



770 gr

GALFER
DF
031
W

øext. 276 mm
øint. 144
4,0



768 gr

GALFER
DF
039
W

øext. 240 mm
øint. 122
4,0



613 gr

GALFER
DF
047
W

øext. 190 mm
øint. 80,5
3,0



268 gr

GALFER
DF
032
W

øext. 316 mm
øint. 144
5,0



1.389 gr

GALFER
DF
040
W

øext. 276 mm
øint. 144
5,0



950 gr

GALFER
DF
048
W

øext. 220 mm
øint. 105
4,2



477 gr

GALFER
DF
037
W

øext. 190 mm
øint. 58
3,6



410 gr

GALFER
DF
041
CW

øext. 310 mm
øint. 62
5,0
21,5

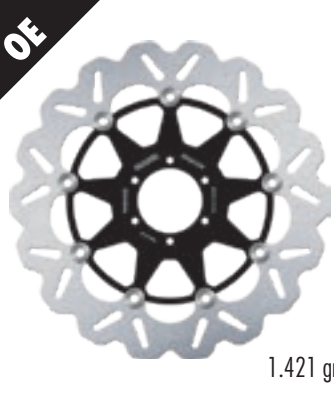

1.421 gr

GALFER
DF
049
W

øext. 256 mm
øint. 144
5,0



742 gr

GALFER
DF
037
RW

øext. 190 mm
øint. 58
3,6



* UNTIL STOCKS END

372 gr

GALFER
DF
042
CW

øext. 310 mm
øint. 58
5,0
21,5

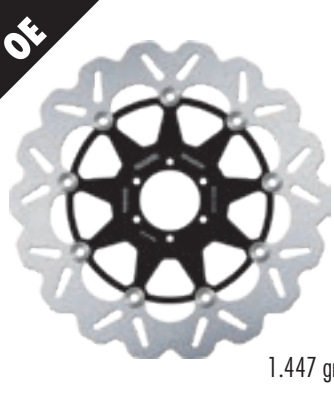

1.447 gr

GALFER
DF
050
W

øext. 220 mm
øint. 89
3,0



382 gr



GALFER	OE		DF
051			CW
310 mm			
62			
4,5			
20,0			
		1.315 gr	

GALFER	OE		DF
061			CW
296 mm			
58			
5,0			
23,25			
		1.196 gr	

GALFER	OE		DF
066			CW I-D
330 mm			
94			
5,0			
12,5			
		1.370 gr	

GALFER	OE		DF
052			W
265 mm			
116			
5,9			
		1.150 gr	

GALFER	OE		DF
062			CW
296 mm			
94			
4,5			
14,5			
		1.123 gr	

GALFER	OE		DF
067			CW
310 mm			
62			
5,0			
18,5			
		1.431 gr	

GALFER	OE		DF
055			W
190 mm			
72			
3,5			
		364 gr	

GALFER	OE		DF
063			CW
296 mm			
94			
5,0			
12,5			
		1.147 gr	

GALFER	OE		DF
068			CW
320 mm			
94			
5,0			
12,5			
		1.372 gr	

GALFER	OE		DF
059			CW
296 mm			
62			
5,0			
23,0			
		1.207 gr	

GALFER	OE		DF
064			W
185 mm			
64,4			
3,5			
		422 gr	

GALFER	OE		DF
068			CRW I-D
320 mm			
94			
5,0			
12,5			
		1.320 gr	

GALFER	OE		DF
060			W
240 mm			
105			
4,0			
		554 gr	

GALFER	OE		DF
065			CW
296 mm			
58			
4,5			
18,0			
		1.180 gr	

GALFER	OE		DF
069			W
240 mm			
122			
3,5			
		480 gr	



APPLICATIONS

PADS FD

DISCS DF

SHOES MF

LINES FK

BRACKETS SP

KITS KG

CROSS REFERENCE

GALFER
DF
069
WLL

øext.	240 mm
øint.	122
	4,0
~	
👣	



640 gr

GALFER
DF
070
FLQ

øext.	310 mm
øint.	94
	5,0
~	12,5
👣	

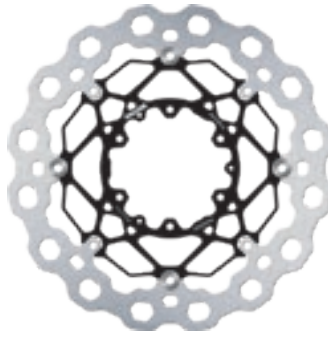

1.397 gr

GALFER
DF
074
W

øext.	320 mm
øint.	212
	5,0
~	
👣	

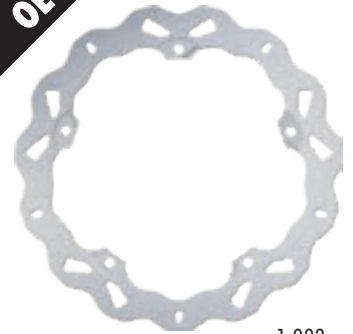

1.083 gr

GALFER
DF
069
RW

øext.	240 mm
øint.	122
	3,5
~	
👣	



503 gr

GALFER
DF
071
W

øext.	220 mm
øint.	105
	4,2
~	
👣	



534 gr

GALFER
DF
075
W

øext.	240 mm
øint.	117,5
	5,0
~	
👣	



766 gr

GALFER
DF
069
FLW

øext.	240 mm
øint.	122
	4,0
~	
👣	

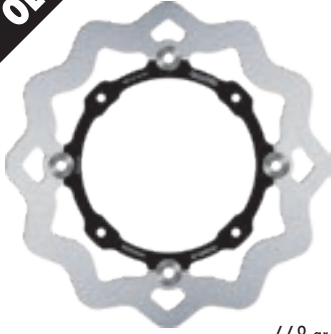

668 gr

GALFER
DF
071
WS

øext.	260 mm
øint.	105
	4,0
~	
👣	sp

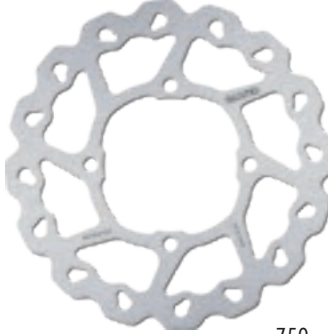

750 gr

GALFER
DF
076
CW I-D

øext.	320 mm
øint.	94
	5,0
~	15,25
👣	

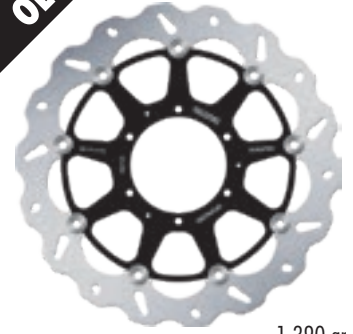

1.390 gr

GALFER
DF
070
CW

øext.	310 mm
øint.	94
	5,0
~	12,5
👣	

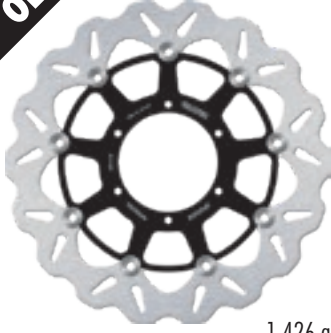

1.426 gr

GALFER
DF
072
W

øext.	240 mm
øint.	116,5
	5,0
~	
👣	



762 gr

GALFER
DF
076
CRW I-D

øext.	320 mm
øint.	94
	5,0
~	15,25
👣	

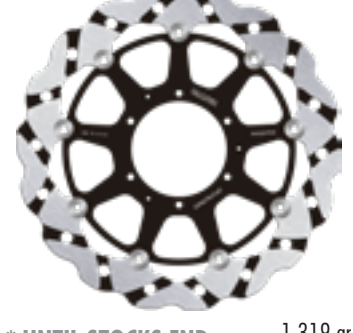

* UNTIL STOCKS END 1.319 gr

GALFER
DF
070
CRW I-D

øext.	310 mm
øint.	94
	5,0
~	12,5
👣	

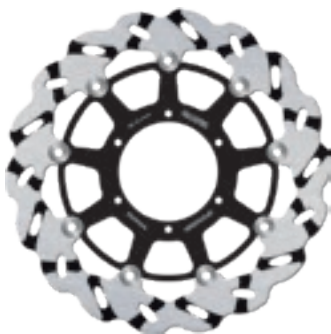

* UNTIL STOCKS END

1.242 gr

GALFER
DF
073
W

øext.	256 mm
øint.	144,5
	4,0
~	
👣	



592 gr

GALFER
DF
078
W

øext.	220 mm
øint.	58
	3,5
~	
👣	



526 gr



GALFER
DF
079
CW

OE

	296
	mm
	94
	4,5
	17,4

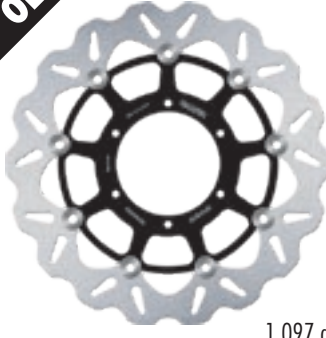

1.097 gr

GALFER
DF
082
RW

	260
	mm
	101
	3,0



510 gr

GALFER
DF
087
W

OE

	183
	mm
	45
	3,5



275 gr

GALFER
DF
080
W

OE

	320
	mm
	211
	5,0



1.130 gr

GALFER
DF
082
WS

SEE DF014 (ø270mm) COMPATIBLE

	270
	mm
	101
	3,0



510 gr

SP001: for CRF models until 2014
SP045: for CRF models from 2015

GALFER
DF
088
W

OE

	256
	mm
	144,5
	4,0



630 gr

GALFER
DF
081
W

OE

	240
	mm
	116,5
	5,0



780 gr

GALFER
DF
082
RWSX

	280
	mm
	101
	3,0



537 gr

SP060

GALFER
DF
089
CW

OE

	320
	mm
	94
	4,5
	15,0

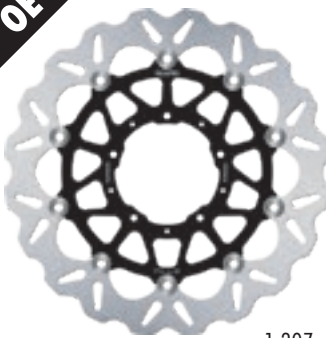

1.307 gr

GALFER
DF
082
W

OE

	260
	mm
	101
	3,0



470 gr

GALFER
DF
083
W

OE

	256
	mm
	144
	4,5



695 gr

GALFER
DF
091
CW

OE

	320
	mm
	74
	5,0
	15,25

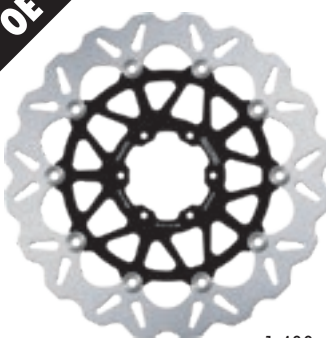

1.400 gr

GALFER
DF
082
FLW

OE

	260
	mm
	101
	3,0



561 gr

GALFER
DF
086
W

OE

	183,8
	mm
	67
	3,5



250 gr

GALFER
DF
092
CW

OE

	310
	mm
	94
	4,5
	13,20



1.181 gr



APPLICATIONS

PADS FD

DISCS DF

SHOES MF

LINES FK

BRACKETS SP

KITS KG

CROSS REFERENCE

GALFER
DF
093
CW

OE

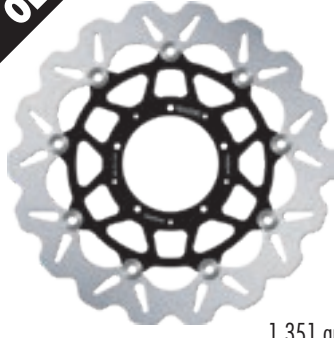

1.351 gr

øext.	320 mm
øint.	94
	4,5
~	12,40
👉	

GALFER
DF
133
CW

OE

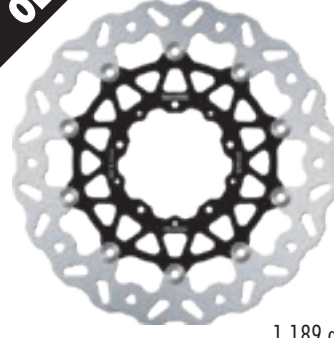

1.189 gr

øext.	310 mm
øint.	94
	4,5
~	12,3
👉	

GALFER
DF
140
W

OE



959 gr

øext.	310 mm
øint.	165
	4,5
~	
👉	

GALFER
DF
094
W

OE



942 gr

øext.	276 mm
øint.	170
	5,8
~	
👉	

GALFER
DF
134
CW

OE

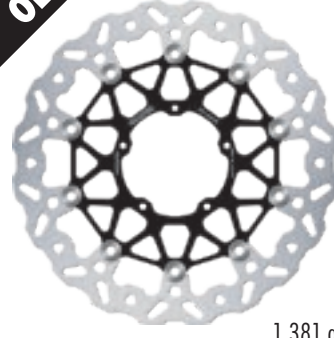

1.381 gr

øext.	330 mm
øint.	94
	5,0
~	18,0
👉	

GALFER
DF
149
W

OE



577 gr

øext.	250 mm
øint.	115
	4,0
~	
👉	

GALFER
DF
097
CW

OE

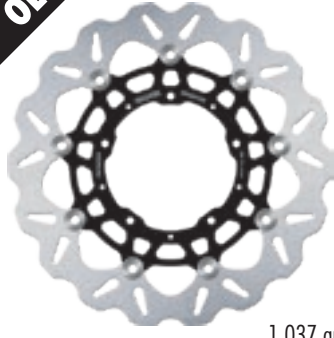

1.037 gr

øext.	296 mm
øint.	109
	4,0
~	9,00
👉	

GALFER
DF
135
W

OE



643 gr

øext.	220 mm
øint.	88
	5,0
~	
👉	

GALFER
DF
149
WLL

OE



658 gr

øext.	250 mm
øint.	115
	4,0
~	
👉	

GALFER
DF
098
W

OE



741 gr

øext.	240 mm
øint.	116
	5,0
~	
👉	

GALFER
DF
136
CW

OE

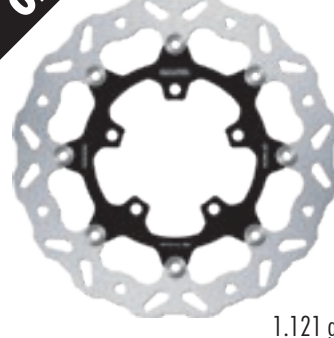

1.121 gr

øext.	310 mm
øint.	105
	4,5
~	
👉	

GALFER
DF
149
RW

OE



553 gr

øext.	250 mm
øint.	115
	4,0
~	
👉	

GALFER
DF
132
FLW

OE



939 gr

øext.	296 mm
øint.	101
	4,0
~	
👉	

GALFER
DF
137
W

OE



739 gr

øext.	240 mm
øint.	116
	5,0
~	
👉	

GALFER
DF
150
FLW

OE



495 gr

øext.	250 mm
øint.	100
	3,0
~	
👉	

OE: Original equipment (original replacement disc) - OE: Equipo original (disco de remplazo del original)

OE discs --> W - FLW - CW - V - FLV

Special discs --> WS - WLL - RW - RH - RWS - FLS - FLX - FRS - FRH - CRW - Q - FLQ

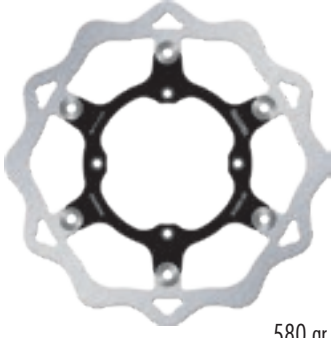

GALFER		580 gr
DF 150 FLS		
øext. 270 mm		
øint. 100		
3,0		
SP005		

GALFER		580 gr
DF 155 W		
øext. 230 mm		
øint. 82		
4,0		

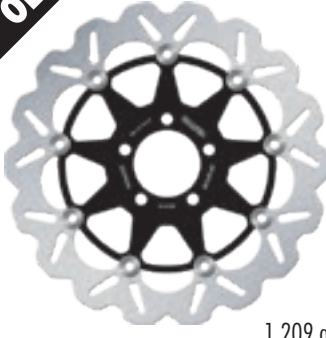
GALFER		1.209 gr
DF 167 CW		
øext. 300 mm		
øint. 61		
5,0		
13,5		

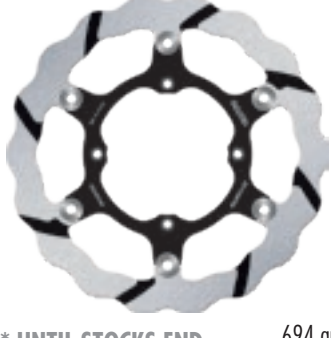
GALFER		694 gr
DF 150 FRS		
øext. 270 mm		
øint. 100		
3,0		
SP005		

* UNTIL STOCKS END

GALFER		592 gr
DF 157 W		
øext. 230 mm		
øint. 120		
4,0		

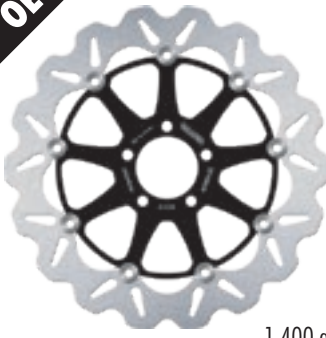
GALFER		1.400 gr
DF 168 CW		
øext. 320 mm		
øint. 61		
5,0		
13,5		

GALFER		533 gr
DF 151 W		
øext. 220 mm		
øint. 101		
4,0		

GALFER		980 gr
DF 159 W		
øext. 270 mm		
øint. 130		
5,0		

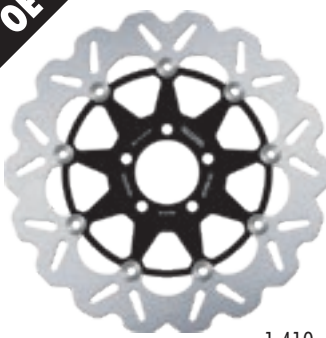
GALFER		1.410 gr
DF 169 CW		
øext. 310 mm		
øint. 61		
5,0		
13,5		

GALFER		533 gr
DF 152 W		
øext. 220 mm		
øint. 100		
4,0		

GALFER		857 gr
DF 161 W		
øext. 250 mm		
øint. 130		
5,0		

GALFER		372 gr
DF 171 W		
øext. 220 mm		
øint. 96		
3,0		

GALFER		1.087 gr
DF 154 W		
øext. 280 mm		
øint. 130		
5,0		

GALFER		358 gr
DF 165 W		
øext. 184 mm		
øint. 84		
3,0		

GALFER		806 gr
DF 172 W		
øext. 260 mm		
øint. 150		
5,0		



APPLICATIONS

PADS FD

DISCS DF

SHOES MF

LINES FK

BRACKETS SP

KITS KG

CROSS REFERENCE

GALFER
DF
173
FLW

OE

	øext.	300	mm
	øint.	130	
		5,0	

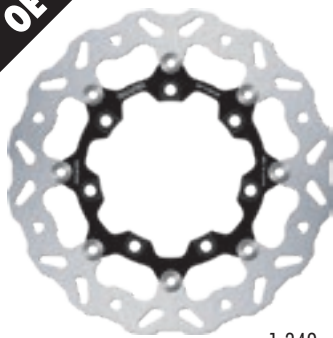

1.349 gr

GALFER
DF
179
WLL

	øext.	240	mm
	øint.	116	
		4,0	



* UNTIL STOCKS END 632 gr

GALFER
DF
182
FRS

	øext.	270	mm
	øint.	100	
		3,0	



* UNTIL STOCKS END 700 gr

GALFER
DF
175
W

OE

	øext.	300	mm
	øint.	130	
		5,0	



1.242 gr

GALFER
DF
179
RW

	øext.	240	mm
	øint.	116	
		4,0	



593 gr

GALFER
DF
183
W

OE

	øext.	240	mm
	øint.	100	
		4,0	



594 gr

GALFER
DF
177
W

OE

	øext.	270	mm
	øint.	130	
		5,0	



1.047 gr

GALFER
DF
180
CW

OE

	øext.	280	mm
	øint.	80	
		5,0	
		0,0	



1.183 gr

GALFER
DF
184
CW

OE

	øext.	300	mm
	øint.	80	
		5,0	
		0,0	



1.244 gr

GALFER
DF
178
CW

OE

	øext.	296	mm
	øint.	61	
		5,0	
		13,5	

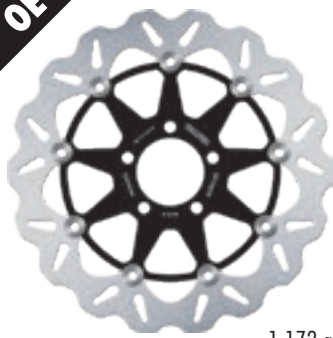

1.172 gr

GALFER
DF
182
FLW

OE

	øext.	250	mm
	øint.	100	
		3,0	



507 gr

GALFER
DF
184
CRW-I-D

	øext.	300	mm
	øint.	80	
		5,0	
		0,0	

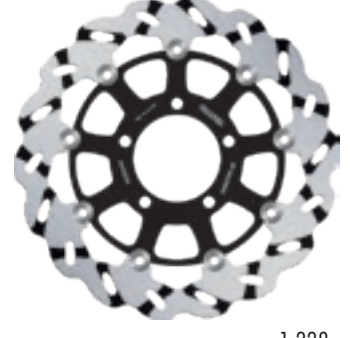

* UNTIL STOCKS END 1.228 gr

GALFER
DF
179
W

OE

	øext.	240	mm
	øint.	116	
		4,0	



522 gr

GALFER
DF
182
FLS

	øext.	270	mm
	øint.	100	
		3,0	



617 gr

GALFER
DF
184
FLQ

	øext.	300	mm
	øint.	80	
		5,0	
		0,0	

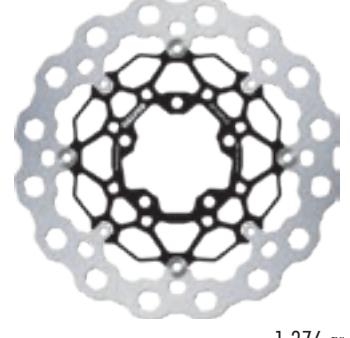

1.376 gr

OE: Original equipment (original replacement disc) - OE: Equipo original (disco de remplazo del original)

OE discs --> W - FLW - CW - V - FLV

Special discs --> WS - WLL - RW - RH - RWS - FLS - FLX - FRS - FRH - CRW - Q - FLQ



GALFER
DF
186
W

OE

	250 mm
	100
	5,0



876 gr

GALFER
DF
191
W

OE

	250 mm
	110
	5,0



870 gr

GALFER
DF
194
CW I-D

OE

	330 mm
	80
	5,0

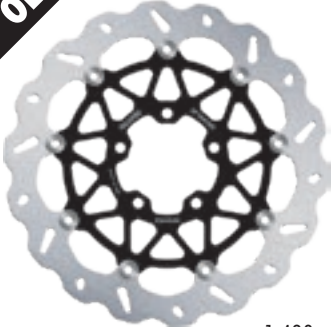

1.490 gr

GALFER
DF
188
W

OE

	230 mm
	100
	4,0



601 gr

GALFER
DF
193
W

OE

	220 mm
	100
	5,0



491 gr

GALFER
DF
194
FLQ

OE

	330 mm
	80
	5,0

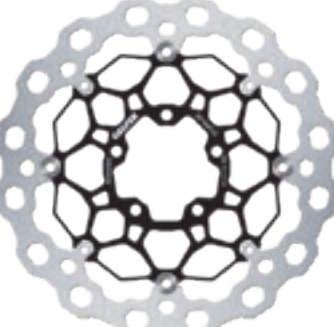

1.532 gr

GALFER
DF
190
CW

OE

REMOVE ORIGINAL SPACE

	310 mm
	80
	5,0
	0,0



1.366 gr

GALFER
DF
193
Q

OE

	220 mm
	100
	5,0



545 gr

GALFER
DF
195
W

OE

	180 mm
	79
	3,0



480 gr

GALFER
DF
190
CRW I-D

OE

REMOVE ORIGINAL SPACE

	310 mm
	80
	5,0
	0,0

* UNTIL STOCKS END

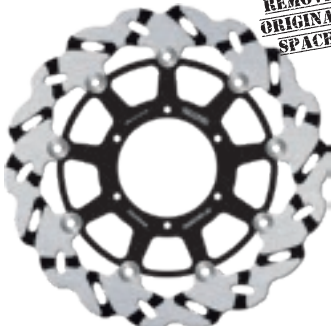

1.325 gr

GALFER
DF
193
WA

OE

	220 mm
	100
	5,0



495 gr

GALFER
DF
196
W

OE

	240 mm
	130
	5,0



710 gr

GALFER
DF
190
FLQ

OE

REMOVE ORIGINAL SPACE

	310 mm
	80
	5,0
	0,0

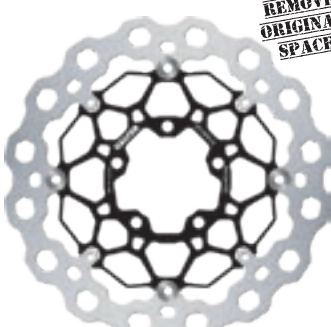

1.412 gr

GALFER
DF
193
QA

OE

	220 mm
	100
	5,0



578 gr

GALFER
DF
197
W

OE

	250 mm
	100
	5,0



880 gr



APPLICATIONS

PADS FD

DISCS DF

SHOES MF

LINES FK

BRACKETS SP

KITS KG

CROSS REFERENCE

GALFER
DF
198
W

OE

	250 mm
	100
	5,0



935 gr

GALFER
DF
200
WS

	270 mm
	109
	3,0
	SP005



498 gr

GALFER
DF
202
W

OE

	240 mm
	100
	4,5



800 gr

GALFER
DF
199
W

OE

	230 mm
	100
	5,0



744 gr

GALFER
DF
200
RWS

	270 mm
	109
	3,0
	SP005



474 gr

GALFER
DF
203
W

OE

	290 mm
	130
	4,5



1.093 gr

GALFER
DF
200
W

OE

	250 mm
	109
	3,0



420 gr

GALFER
DF
200
FLS

	270 mm
	109
	3,0
	SP005



527 gr

GALFER
DF
203
FLW

OE

	290 mm
	130
	4,5



* UNTIL STOCKS END 1.200 gr

GALFER
DF
200
FLW

OE

	250 mm
	109
	3,0

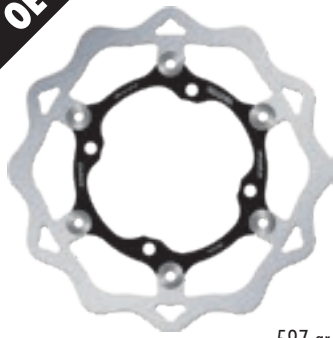

597 gr

GALFER
DF
200
FRS

	270 mm
	109
	3,0
	SP005

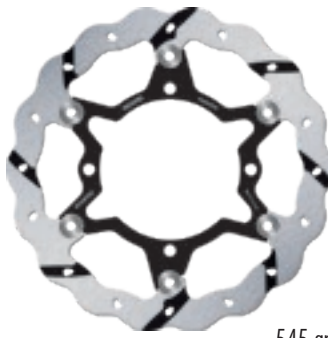

545 gr

GALFER
DF
203
CW

	290 mm
	130
	4,5

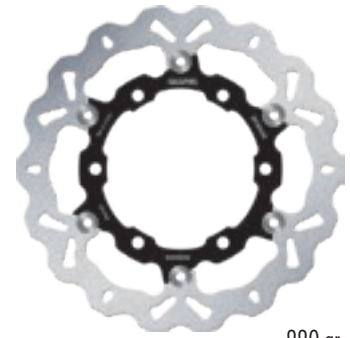

990 gr

GALFER
DF
200
RW

OE

	250 mm
	109
	3,0



* UNTIL STOCKS END 401 gr

GALFER
DF
201
W

OE

	250 mm
	100
	3,5



650 gr

GALFER
DF
204
W

OE

	220 mm
	101
	4,6



743 gr



GALFER
DF
205
CW

OE

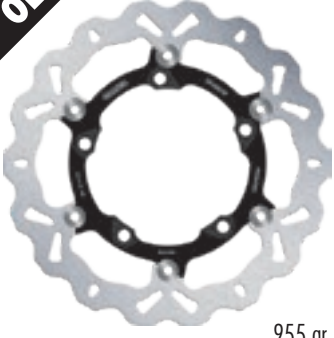

955 gr

	290 mm
	130
	4,5

GALFER
DF
209
W

OE



360 gr

	220 mm
	112
	3,0

GALFER
DF
215
FLW

OE



1.268 gr

	300 mm
	142
	5,0

GALFER
DF
206
W

OE



1.150 gr

	270 mm
	110
	5,0

GALFER
DF
211
CW

OE

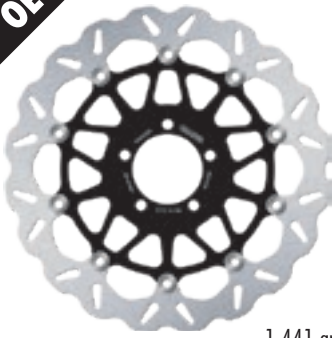

1.441 gr

	330 mm
	70
	5,0
	12,0

GALFER
DF
298
W

OE



490 gr

SEE DF301 WS COMPATIBLE

	270 mm
	118
	3,0

GALFER
DF
208
W

OE



498 gr

SEE DF200 (ø270mm) COMPATIBLE

	270 mm
	109
	3,0

GALFER
DF
211
FLQ

OE

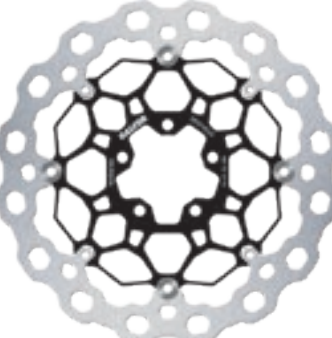

1.566 gr

	330 mm
	70
	5,0
	12,0

GALFER
DF
298
FLW

OE

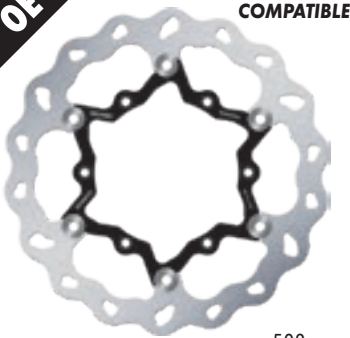

508 gr

SEE DF301 FLS COMPATIBLE

	270 mm
	118
	3,0

GALFER
DF
208
FLW

OE



587 gr

SEE DF200 (ø270mm) COMPATIBLE

	270 mm
	109
	3,0

GALFER
DF
213
WF

OE



686 gr

	220 mm
	100
	5,0

GALFER
DF
298
RW

OE



463 gr

SEE DF301 RWS COMPATIBLE

	270 mm
	118
	3,0

GALFER
DF
208
RWSX

OE



525 gr

	280 mm
	109
	3,0
	SP057

GALFER
DF
214
FLW

OE



1.185 gr

	310 mm
	142
	4,5

GALFER
DF
298
FRW

OE

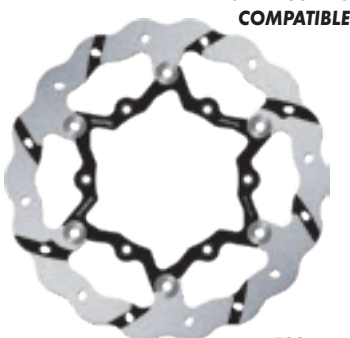

532 gr

SEE DF301 FRS COMPATIBLE

	270 mm
	118
	3,0



APPLICATIONS

PADS FD

DISCS DF

SHOES MF

LINES FK

BRACKETS SP

KITS KG

CROSS REFERENCE

GALFER
DF
298
RWSX

	øext.	280
	mm	
	øint.	118
		3,0
		SP056



552 gr

GALFER
DF
301
RWS

	øext.	270
	mm	
	øint.	118
		3,0
		SP004 SP023



463 gr

SP004: for YZ models until 2007 & all WR models
SP023: for YZ models from 2008

GALFER
DF
307
W

	øext.	240
	mm	
	øint.	89
		4,0



687 gr

GALFER
DF
301
W

	øext.	250
	mm	
	øint.	118
		3,0



452 gr

GALFER
DF
301
FLS

	øext.	270
	mm	
	øint.	118
		3,0
		SP004 SP023

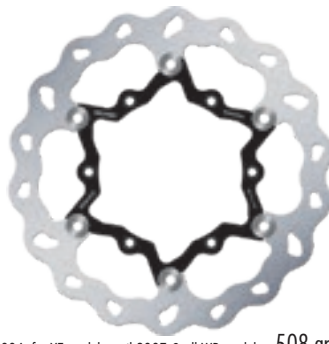

508 gr

SP004: for YZ models until 2007 & all WR models
SP023: for YZ models from 2008

GALFER
DF
312
W

	øext.	210
	mm	
	øint.	81
		4,0



490 gr

GALFER
DF
301
FLW

	øext.	250
	mm	
	øint.	118
		3,0



546 gr

GALFER
DF
301
FRS

	øext.	270
	mm	
	øint.	118
		3,0
		SP004 SP023

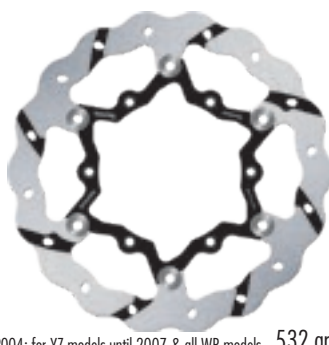

532 gr

SP004: for YZ models until 2007 & all WR models
SP023: for YZ models from 2008

GALFER
DF
314
CW

	øext.	310
	mm	
	øint.	64
		5,0
		19,5

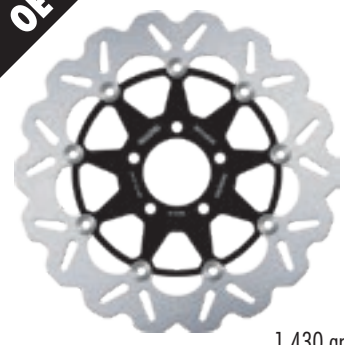

1.430 gr

GALFER
DF
301
RW

	øext.	250
	mm	
	øint.	118
		3,0



410 gr

GALFER
DF
302
W

	øext.	220
	mm	
	øint.	118
		4,0



466 gr

GALFER
DF
315
W

	øext.	300
	mm	
	øint.	121
		4,0

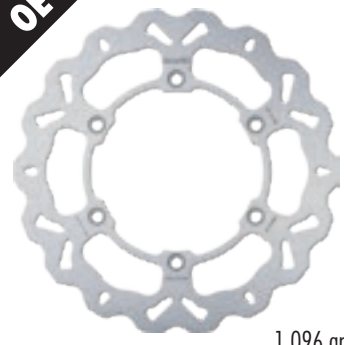

1.096 gr

GALFER
DF
301
WS

	øext.	270
	mm	
	øint.	118
		3,0
		SP004 SP023

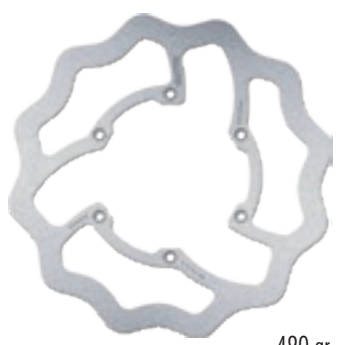

490 gr

GALFER
DF
306
W

	øext.	250
	mm	
	øint.	121
		3,5



444 gr

GALFER
DF
316
W

	øext.	250
	mm	
	øint.	84
		4,0



775 gr

OE: Original equipment (original replacement disc) - OE: Equipo original (disco de remplazo del original)

OE discs --> W - FLW - CW - V - FLV

Special discs --> WS - WLL - RW - RH - RWS - FLS - FLX - FRS - FRH - CRW - Q - FLQ



GALFER
DF
317
CW

OE

	290 mm
	64
	5,0
	19,5

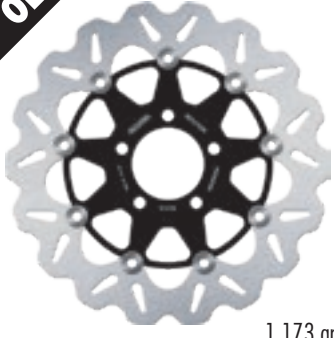

1.173 gr

GALFER
DF
321
CW

OE

	300 mm
	64
	5,0
	19,5

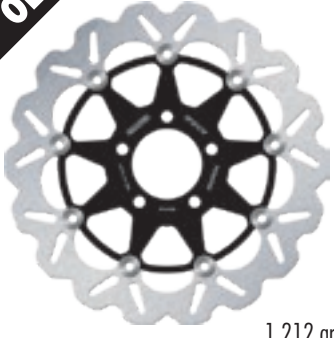

1.212 gr

GALFER
DF
326
CW

OE

	310 mm
	61
	5,0
	21,5

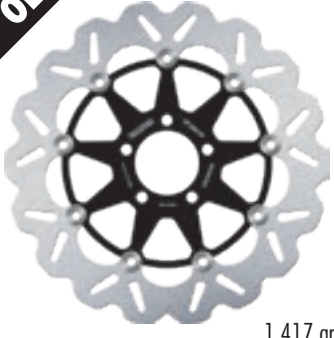

1.417 gr

GALFER
DF
318
W

OE

	220 mm
	100
	4,0



549 gr

GALFER
DF
322
CW

OE

	300 mm
	69
	5,0
	0,0

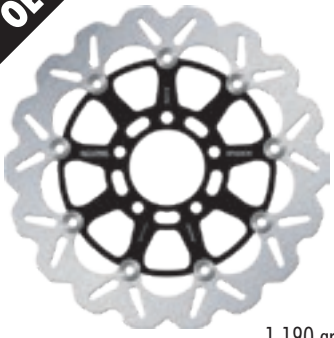

1.190 gr

GALFER
DF
327
FLW

OE

	290 mm
	121
	4,0

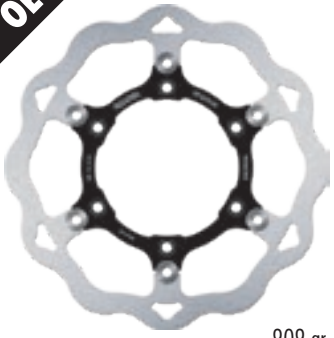

909 gr

GALFER
DF
319
W

OE

	220 mm
	64
	4,0



665 gr

GALFER
DF
323
CW

OE

	310 mm
	69
	5,0
	0,0

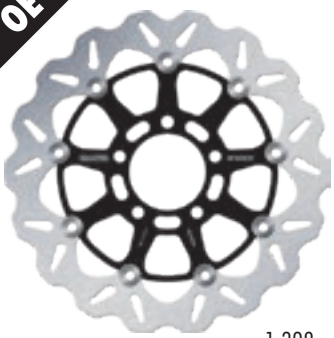

1.398 gr

GALFER
DF
328
W

OE

	240 mm
	118
	4,0



567 gr

GALFER
DF
320
CW

OE

	320 mm
	69
	5,0
	0,0

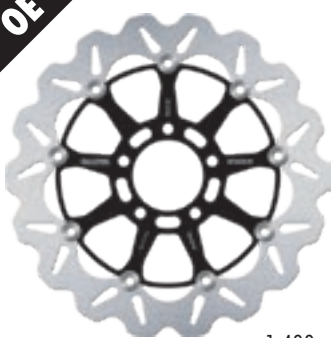

1.400 gr

GALFER
DF
325
CW

OE

	320 mm
	102
	5,0

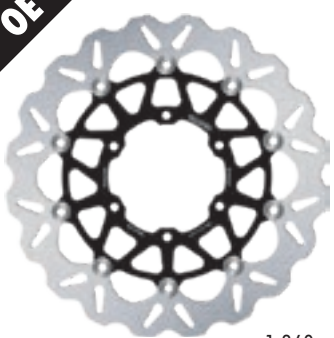

1.360 gr

GALFER
DF
329
W

OE

	200 mm
	84
	3,5



455 gr

GALFER
DF
320
CRW-I-D

OE

	320 mm
	69
	5,0
	0,0

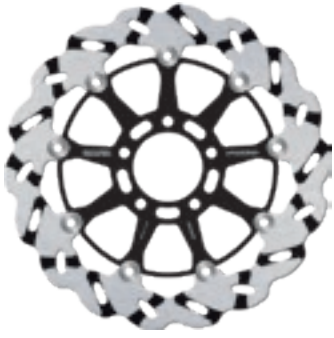

* UNTIL STOCKS END 1.293 gr

GALFER
DF
325
FLQ

OE

	320 mm
	102
	5,0

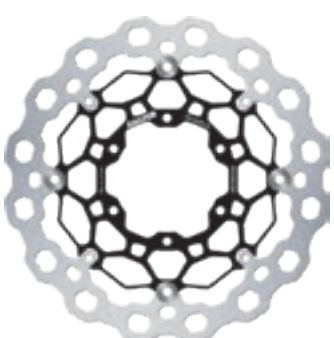

1.435 gr

GALFER
DF
330
W

OE

	260 mm
	121
	4,5



845 gr



APPLICATIONS

PADS FD

DISCS DF

SHOES MF

LINES FK

BRACKETS SP

KITS KG

CROSS REFERENCE

GALFER
DF
331
FLW

	øext.	260
	mm	
	øint.	121
		4,5



GALFER
DF
339
W

	øext.	220
	mm	
	øint.	89
		5,0



GALFER
DF
344
W

	øext.	260
	mm	
	øint.	121
		4,5



GALFER
DF
332
W

	øext.	290
	mm	
	øint.	190
		4,5



GALFER
DF
339
FLW

	øext.	220
	mm	
	øint.	90
		5,0

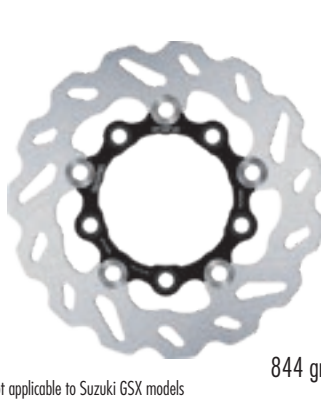

Not applicable to Suzuki GSX models

GALFER
DF
346
W

	øext.	260
	mm	
	øint.	105
		5,0



GALFER
DF
334
CW

	øext.	290
	mm	
	øint.	121
		5,0
		0,0



GALFER
DF
339
Q

	øext.	220
	mm	
	øint.	89
		5,0

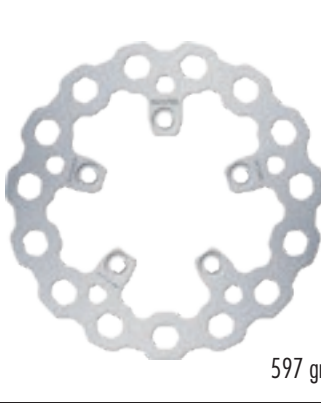

GALFER
DF
348
CW

	øext.	310
	mm	
	øint.	100
		5,0
		0,0



GALFER
DF
337
CW

	øext.	290
	mm	
	øint.	69
		5,0
		0,0

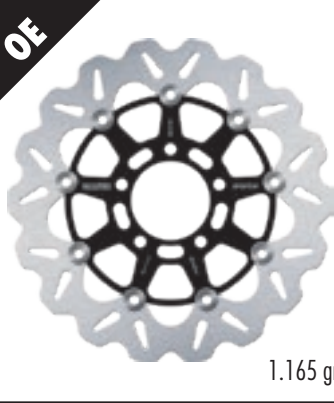

GALFER
DF
341
W

	øext.	260
	mm	
	øint.	121
		4,0



GALFER
DF
348
CRW-D

	øext.	310
	mm	
	øint.	100
		5,0
		0,0

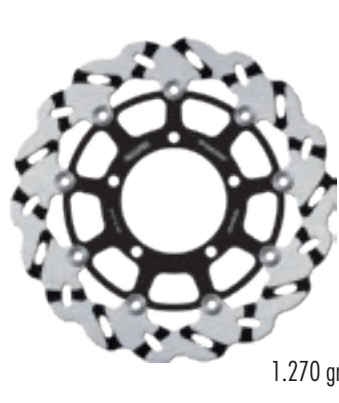

GALFER
DF
338
W

	øext.	240
	mm	
	øint.	118
		3,5



GALFER
DF
342
W

	øext.	210
	mm	
	øint.	109
		5,0



GALFER
DF
348
FLQ

	øext.	310
	mm	
	øint.	100
		5,0
		0,0

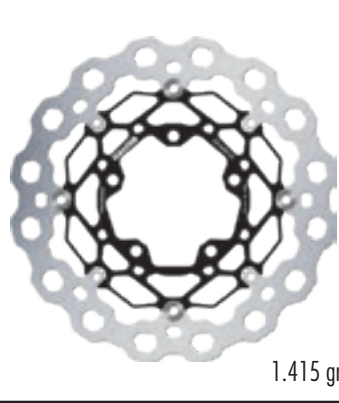

OE: Original equipment (original replacement disc) - OE: Equipo original (disco de remplazo del original)

OE discs --> W - FLW - CW - V - FLV

Special discs --> WS - WLL - RW - RH - RWS - FLS - FLX - FRS - FRH - CRW - Q - FLQ



GALFER	DF	349	W			250
						mm
						118
						3,0
						SP005
452 gr						

GALFER	DF	349	FLS			270
						mm
						118
						3,0
						SP005
509 gr						

GALFER	DF	351	CW			310
						mm
						121
						5,0
						0,0
1.325 gr						

GALFER	DF	349	FLW			250
						mm
						118
						3,0
						SP005
520 gr						

GALFER	DF	349	FRS			270
						mm
						118
						3,0
						SP005
* UNTIL STOCKS END 532 gr						

GALFER	DF	352	W			240
						mm
						120
						5,0
						SP005
803 gr						

GALFER	DF	349	RW			250
						mm
						118
						3,0
						SP005
* UNTIL STOCKS END 401 gr						

GALFER	DF	350	W			240
						mm
						122
						4,0
						SP005
483 gr						

GALFER	DF	353	W			200
						mm
						100,5
						3,5
						SP005
323 gr						

GALFER	DF	349	WS			270
						mm
						118
						3,0
						SP005
498 gr						

GALFER	DF	350	WLL			240
						mm
						122
						4,0
						SP005
524 gr						

GALFER	DF	354	W			240
						mm
						118
						4,0
						SP005
529 gr						

GALFER	DF	349	RWS			270
						mm
						118
						3,0
						SP005
474 gr						

GALFER	DF	350	RW			240
						mm
						122
						4,0
						SP005
537 gr						

GALFER	DF	355	W			260
						mm
						140
						5,0
						SP005
875 gr						

APPLICATIONS
 PADS FD
 DISCS DF
 SHOES MF
 LINES FK
 BRACKETS SP
 KITS KG
 CROSS REFERENCE



APPLICATIONS

PADS FD

DISCS DF

SHOES MF

LINES FK

BRACKETS SP

KITS KG

CROSS REFERENCE

GALFER
DF
356
W

	163
	mm
	34
	3,8



GALFER
DF
360
W

	210
	mm
	89
	5,0



GALFER
DF
365
W

	220
	mm
	89
	4,5



GALFER
DF
358
CW

	310
	mm
	102
	5,0
	0,0

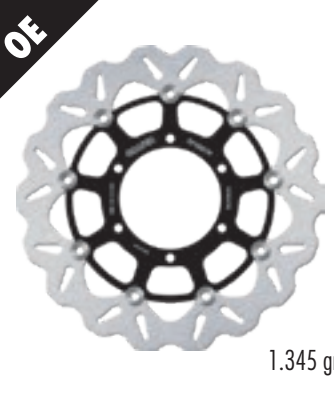

GALFER
DF
361
W

	260
	mm
	141
	5,0



GALFER
DF
366
W

	200
	mm
	48,3
	3,5



GALFER
DF
358
CRW-I-D

	310
	mm
	102
	5,0
	0,0

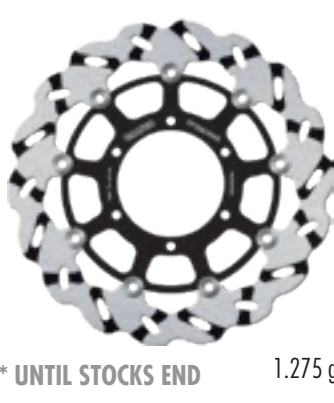

GALFER
DF
362
W

	200
	mm
	96
	4,0



GALFER
DF
367
W

	185
	mm
	74,3
	4,0



GALFER
DF
358
FLQ

	310
	mm
	102
	5,0
	0,0

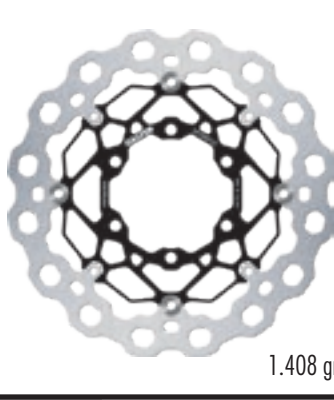

GALFER
DF
363
W

	250
	mm
	117
	5,0



GALFER
DF
368
W

	270
	mm
	118
	3,0



SEE DF349WS
COMPATIBLE

GALFER
DF
359
CW

	275
	mm
	89
	5,6
	6,65



GALFER
DF
364
W

	240
	mm
	89
	4,5









GALFER
DF
368
RW

	270
	mm
	118
	3,0



SEE DF349RWS
COMPATIBLE



GALFER DF 368 FLW <small>øext.</small> 270 mm <small>øint.</small> 118  3,0 	OE  SEE DF349FLS COMPATIBLE 509 gr	GALFER DF 370 Q <small>øext.</small> 220 mm <small>øint.</small> 110  5,0 	 552 gr	GALFER DF 410 W <small>øext.</small> 260 mm <small>øint.</small> 105,5  5,0 	OE  976 gr
GALFER DF 368 FRW <small>øext.</small> 270 mm <small>øint.</small> 118  3,0 	 SEE DF349FRS COMPATIBLE 532 gr	GALFER DF 371 CW <small>øext.</small> 310 mm <small>øint.</small> 110  5,0 	OE  1.213 gr	GALFER DF 411 W <small>øext.</small> 220 mm <small>øint.</small> 90,5  4,0 	OE  542 gr
GALFER DF 368 RWSX <small>øext.</small> 280 mm <small>øint.</small> 118  3,0  SP057	 540 gr	GALFER DF 372 W <small>øext.</small> 250 mm <small>øint.</small> 120  5,0 	OE  846 gr	GALFER DF 412 W <small>øext.</small> 260 mm <small>øint.</small> 87,5  4,0 	OE  794 gr
GALFER DF 369 W <small>øext.</small> 190 mm <small>øint.</small> 63,2  5,0 	OE  575 gr	GALFER DF 373 W <small>øext.</small> 300 mm <small>øint.</small> 130  5,0 	OE  1.400 gr	GALFER DF 413 W <small>øext.</small> 240 mm <small>øint.</small> 126,5  5,0 	OE  698 gr
GALFER DF 370 W <small>øext.</small> 220 mm <small>øint.</small> 110  5,0 	OE  662 gr	GALFER DF 374 W <small>øext.</small> 220 mm <small>øint.</small> 81,2  4,0 	OE  575 gr	GALFER DF 414 W <small>øext.</small> 220 mm <small>øint.</small> 60  3,5 	OE  606 gr



APPLICATIONS

PADS FD

DISCS DF

SHOES MF

LINESS FK

BRACKETS SP

KITS KG

CROSS REFERENCE

GALFER
DF
415
FLW

OE

øext.	270 mm
øint.	88
▶▶	4,5
☒	
☑	



1.068 gr

GALFER
DF
450
W

OE

øext.	245 mm
øint.	86
▶▶	3,0
☒	
☑	



474 gr

GALFER
DF
454
W

OE

øext.	245 mm
øint.	115
▶▶	4,0
☒	
☑	



672 gr

GALFER
DF
440
FLW

OE

øext.	300 mm
øint.	132
▶▶	5,0
☒	
☑	



1.415 gr

GALFER
DF
451
W

OE

øext.	220 mm
øint.	115
▶▶	4,0
☒	
☑	



452 gr

GALFER
DF
455
FLW

OE

øext.	280 mm
øint.	130
▶▶	4,5
☒	
☑	



1.065 gr

GALFER
DF
441
W

OE

øext.	198 mm
øint.	100
▶▶	3,0
☒	
☑	



261 gr

GALFER
DF
451
WLL

OE

øext.	220 mm
øint.	115
▶▶	4,0
☒	
☑	



566 gr

GALFER
DF
456
W

OE

øext.	245 mm
øint.	115
▶▶	5,0
☒	
☑	



770 gr

GALFER
DF
448
FLW

OE

øext.	298 mm
øint.	132
▶▶	4,5
☒	0,0
☑	



1.110 gr

GALFER
DF
452
W

OE

øext.	267 mm
øint.	118
▶▶	4,0
☒	
☑	



780 gr

GALFER
DF
457
W

OE

øext.	230 mm
øint.	86
▶▶	3,0
☒	
☑	



466 gr

GALFER
DF
448
CW

OE

øext.	298 mm
øint.	132
▶▶	4,5
☒	0,0
☑	

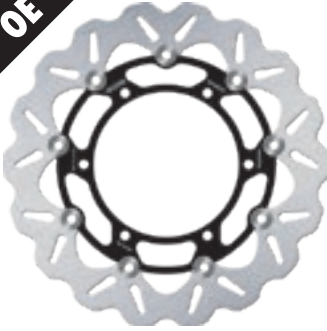

* UNTIL STOCKS END

1.091 gr

GALFER
DF
453
W

OE

øext.	267 mm
øint.	132
▶▶	4,0
☒	
☑	



788 gr

GALFER
DF
458
W

OE

øext.	245 mm
øint.	115
▶▶	4,5
☒	
☑	



711 gr

OE: Original equipment (original replacement disc) - OE: Equipo original (disco de remplazo del original)

OE discs --> W - FLW - CW - V - FLV

Special discs --> WS - WLL - RW - RH - RWS - FLS - FLX - FRS - FRH - CRW - Q - FLQ



GALFER
DF
459
W

OE

	282
mm	
	132
	5,0



1.231 gr

GALFER
DF
463
W

OE

	320
mm	
	198
	5,0



1.125 gr

GALFER
DF
469
W

OE

	245
mm	
	132
	5,0



845 gr

GALFER
DF
460
FLW

OE

	298
mm	
	132
	4,5
	0,0



1.110 gr

GALFER
DF
464
W

OE

	245
mm	
	115
	3,0



443 gr

GALFER
DF
470
W

OE

	282
mm	
	132
	4,0



898 gr

GALFER
DF
460
CW

OE

	298
mm	
	132
	4,5
	0,0



1.010 gr

GALFER
DF
466
W

OE

	155
mm	
	41
	3,5



291 gr

GALFER
DF
471
W

OE

	267
mm	
	132
	5,0



1.121 gr

GALFER
DF
461
W

OE

	220
mm	
	105
	4,5



559 gr

GALFER
DF
467
W

OE

	220
mm	
	86
	4,0



624 gr

GALFER
DF
472
FLV

OE

	298
mm	
	64
	5,0
	10,5

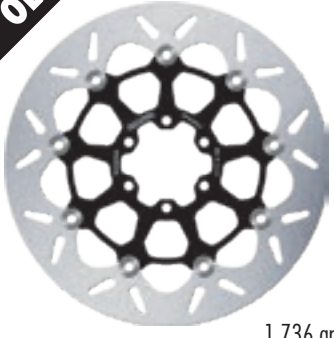

1.736 gr

GALFER
DF
462
W

OE

	245
mm	
	118
	3,0



476 gr

GALFER
DF
468
W

OE

	210
mm	
	84
	4,0



569 gr

GALFER
DF
472
FLW

OE

	298
mm	
	64
	5,0
	10,5

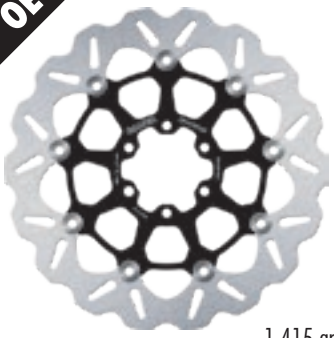

1.415 gr



APPLICATIONS

PADS FD

DISCS DF

SHOES MF

LINES FK

BRACKETS SP

KITS KG

CROSS REFERENCE

**GALFER
DF
472
FLQ**

øext.	298
mm	
øint.	64
▶▶	5,0
⌒	10,5
👣	

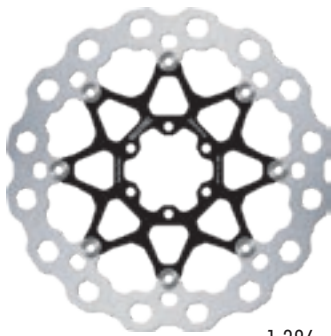

1.386 gr

**GALFER
DF
475
CRW-I-D**

øext.	320
mm	
øint.	132
▶▶	5,0
⌒	0,0
👣	

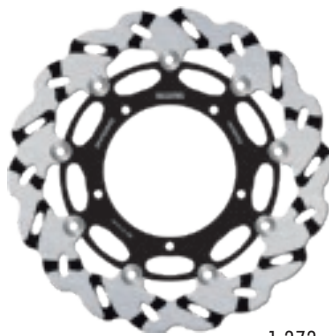

1.373 gr

**GALFER
DF
479
W**

øext.	240
mm	
øint.	115
▶▶	4,0
⌒	
👣	



630 gr

**GALFER
DF
473
W**

øext.	180
mm	
øint.	48
▶▶	3,5
⌒	
👣	



375 gr

**GALFER
DF
475
FLQ**

øext.	320
mm	
øint.	132
▶▶	5,0
⌒	0,0
👣	

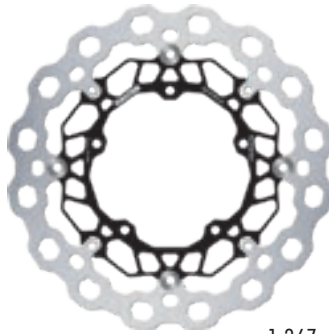

1.367 gr

**GALFER
DF
481
CW**

øext.	298
mm	
øint.	64
▶▶	5,0
⌒	18,5
👣	

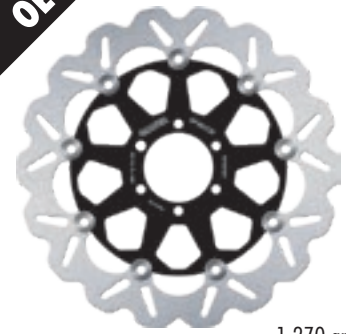

1.270 gr

**GALFER
DF
473
RW**

øext.	180
mm	
øint.	48
▶▶	3,5
⌒	
👣	



367 gr

* UNTIL STOCKS END

**GALFER
DF
476
W**

øext.	220
mm	
øint.	58,3
▶▶	4,0
⌒	
👣	



501 gr

**GALFER
DF
482
CW**

øext.	310
mm	
øint.	132
▶▶	5,0
⌒	0,0
👣	

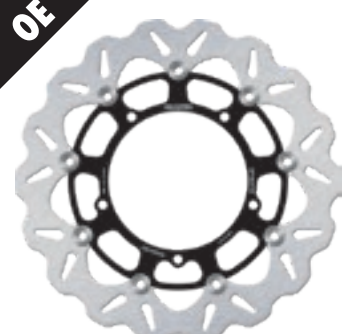

1.252 gr

**GALFER
DF
474
CW**

øext.	298
mm	
øint.	132
▶▶	5,0
⌒	0,0
👣	

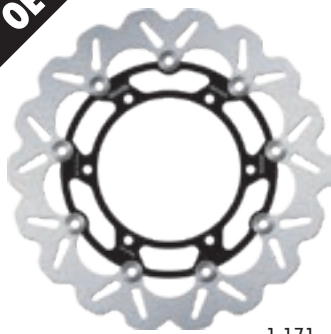

1.171 gr

**GALFER
DF
477
W**

øext.	160
mm	
øint.	48,5
▶▶	3,5
⌒	
👣	



280 gr

**GALFER
DF
482
CRW-I-D**

øext.	310
mm	
øint.	132
▶▶	5,0
⌒	0,0
👣	

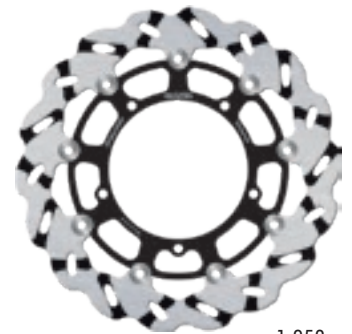

1.253 gr

**GALFER
DF
475
CW**

øext.	320
mm	
øint.	132
▶▶	5,0
⌒	0,0
👣	



1.375 gr

**GALFER
DF
478
W**

øext.	244,5
mm	
øint.	58
▶▶	4,0
⌒	
👣	



860 gr

**GALFER
DF
484
W**

øext.	230
mm	
øint.	116
▶▶	5,0
⌒	
👣	



635 gr



GALFER
DF
485
W

OE

øext.	245 mm
øint.	105
	5,0
⌒	
👣	



890 gr

GALFER
DF
489
WS

øext.	250 mm
øint.	100
	3,0
⌒	
👣	SP049

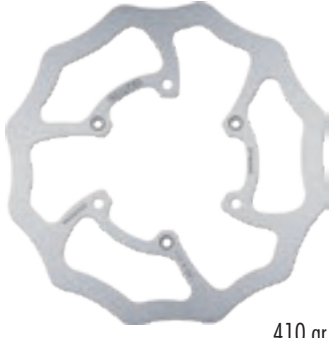

410 gr

GALFER
DF
493
W

OE

øext.	282 mm
øint.	132
	4,0
⌒	
👣	



870 gr

GALFER
DF
486
W

OE

øext.	220 mm
øint.	92
	3,0
⌒	
👣	



380 gr

GALFER
DF
489
RWS

øext.	250 mm
øint.	100
	3,0
⌒	
👣	SP049



390 gr

GALFER
DF
494
W

OE

øext.	267 mm
øint.	132
	4,5
⌒	
👣	



906 gr

GALFER
DF
487
W

OE

øext.	203 mm
øint.	84
	4,5
⌒	
👣	



522 gr

GALFER
DF
490
W

OE

øext.	230 mm
øint.	84
	5,0
⌒	
👣	



641 gr

GALFER
DF
495
CW

OE

øext.	298 mm
øint.	132
	5,0
⌒	0,0
👣	

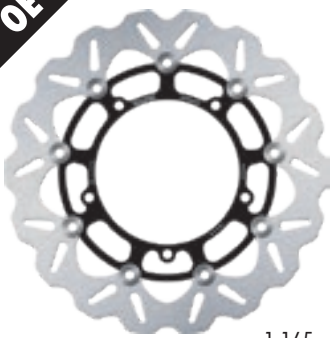

1.165 gr

GALFER
DF
488
W

OE

øext.	298 mm
øint.	132
	5,0
⌒	
👣	



1.461 gr

GALFER
DF
491
W

OE

øext.	220 mm
øint.	116
	5,0
⌒	
👣	



418 gr

GALFER
DF
495
CRW-I-D

øext.	298 mm
øint.	132
	5,0
⌒	0,0
👣	

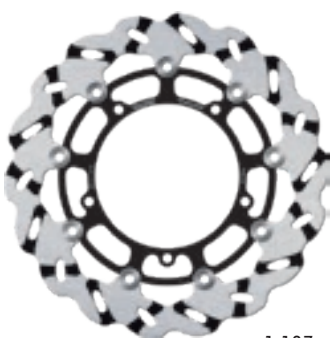

1.137 gr

GALFER
DF
489
W

OE

øext.	220 mm
øint.	100
	3,0
⌒	
👣	



373 gr

GALFER
DF
492
W

OE

øext.	220 mm
øint.	54
	4,0
⌒	
👣	



645 gr

GALFER
DF
496
W

OE

øext.	220 mm
øint.	105
	4,5
⌒	
👣	



640 gr



APPLICATIONS

PADS FD

DISCS DF

SHOES MF

LINES FK

BRACKETS SP

KITS KG

CROSS REFERENCE

GALFER
DF
496
Q

øext.	220 mm
øint.	105
▶▶	4,5
⌒	
👣	

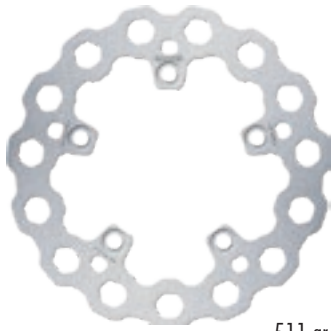

511 gr

GALFER
DF
499
RW

øext.	245 mm
øint.	115
▶▶	4,0
⌒	
👣	



610 gr

GALFER
DF
503
FLW

øext.	267 mm
øint.	132
▶▶	4,0
⌒	
👣	

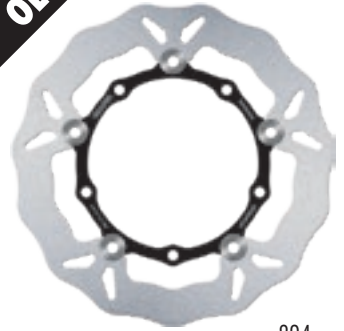

894 gr

GALFER
DF
497
W

øext.	190 mm
øint.	85
▶▶	3,0
⌒	
👣	



268 gr

GALFER
DF
500
W

øext.	267 mm
øint.	132
▶▶	5,0
⌒	
👣	



1.023 gr

GALFER
DF
504
W

øext.	220 mm
øint.	82
▶▶	4,0
⌒	
👣	



605 gr

GALFER
DF
498
CW

øext.	320 mm
øint.	132
▶▶	5,0
⌒	0,0
👣	

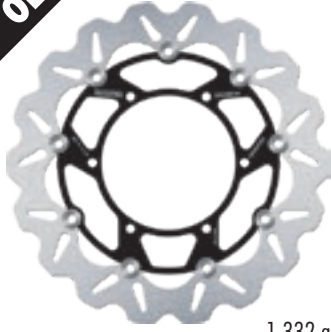

1.332 gr

GALFER
DF
501
W

øext.	267 mm
øint.	132
▶▶	5,0
⌒	
👣	



931 gr

GALFER
DF
504
FLS

øext.	260 mm
øint.	82
▶▶	4,0
⌒	
👣	SP015

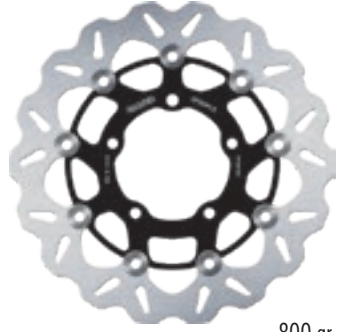

800 gr

GALFER
DF
499
W

øext.	245 mm
øint.	115
▶▶	4,0
⌒	
👣	



622 gr

GALFER
DF
502
W

øext.	245 mm
øint.	108
▶▶	4,0
⌒	
👣	



692 gr

GALFER
DF
508
W

øext.	220 mm
øint.	58
▶▶	4,0
⌒	
👣	



573 gr

GALFER
DF
499
WLL

øext.	245 mm
øint.	115
▶▶	4,0
⌒	
👣	

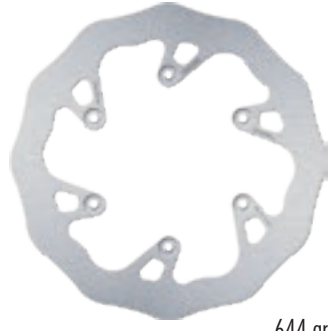

644 gr

GALFER
DF
503
W

øext.	267 mm
øint.	132
▶▶	4,0
⌒	
👣	



775 gr

GALFER
DF
509
W

øext.	245 mm
øint.	82
▶▶	4,0
⌒	
👣	



690 gr

OE: Original equipment (original replacement disc) - OE: Equipo original (disco de remplazo del original)

OE discs --> W - FLW - CW - V - FLV

Special discs --> WS - WLL - RW - RH - RWS - FLS - FLX - FRS - FRH - CRW - Q - FLQ



GALFER
DF
511
W

OE

	245 mm
	115
	5,0



840 gr

GALFER
DF
515
WLL

	245 mm
	115
	4,0



645 gr

GALFER
DF
518
FLW

OE

	298 mm
	64
	5,0

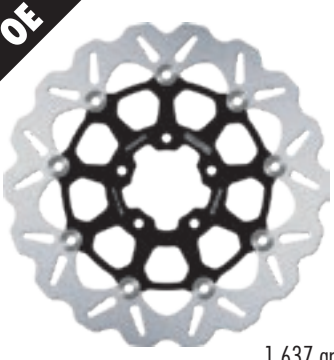

1.637 gr

GALFER
DF
512
CW

OE

	267 mm
	58
	4,0

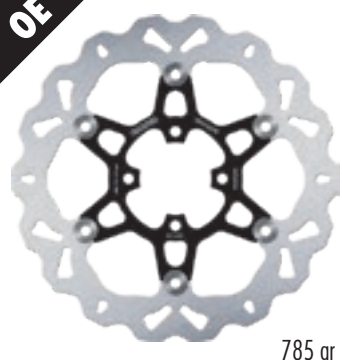

785 gr

GALFER
DF
515
RW

	245 mm
	115
	4,0



454 gr

GALFER
DF
519
CW I-D

OE

	310 mm
	132
	5,0
	0,0

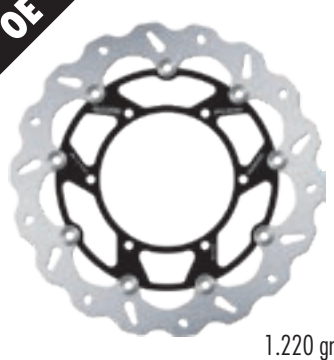

1.220 gr

GALFER
DF
512
WS

	300 mm
	59
	4,0
	SP



1.122 gr

GALFER
DF
516
W

OE

	245 mm
	115
	5,0



777 gr

GALFER
DF
520
CW I-D

OE

	310 mm
	132
	5,0
	0,0

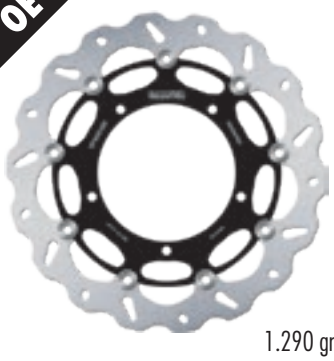

1.290 gr

GALFER
DF
513
W

OE

	298 mm
	133
	5,0



1.460 gr

GALFER
DF
517
W

OE

	240 mm
	115
	5,0



715 gr

GALFER
DF
520
CRW I-D

OE

	310 mm
	132
	5,0
	0,0

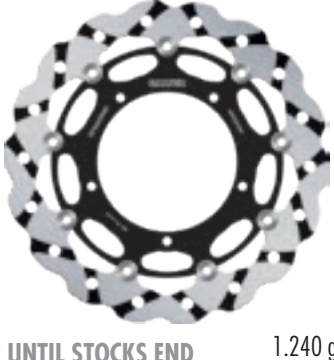

* UNTIL STOCKS END
1.240 gr

GALFER
DF
515
W

OE

	245 mm
	115
	4,0



612 gr

GALFER
DF
518
W

OE

	298 mm
	64
	5,0



1.648 gr

GALFER
DF
522
W

OE

	267 mm
	132
	4,5

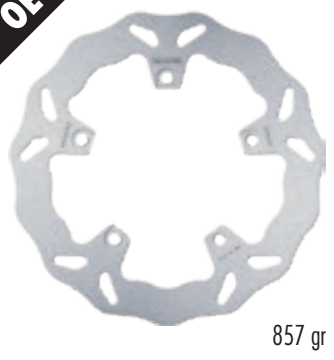

857 gr



APPLICATIONS

PADS

DISCS

SHOES

LINES

BRACKETS

KITS

CROSS REFERENCE

GALFER
DF
523
W

OE

	øext.	245	mm
	øint.	132	
		5,0	



742 gr

GALFER
DF
528
W

OE

	øext.	282	mm
	øint.	131,5	
		5,0	



1.070 gr

GALFER
DF
532
FLS

	øext.	267	mm
	øint.	115	
		4,0	
			SP

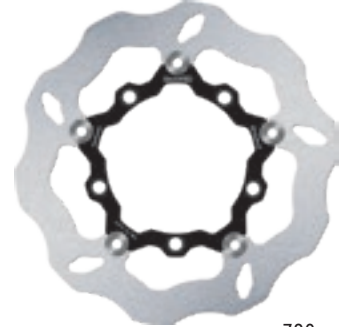

790 gr

GALFER
DF
524
W

OE

	øext.	240	mm
	øint.	92	
		5,0	



877 gr

GALFER
DF
530
W

OE

	øext.	203	mm
	øint.	84	
		4,0	



520 gr

GALFER
DF
533
W

OE

	øext.	203	mm
	øint.	84	
		4,0	



460 gr

GALFER
DF
525
FLW

OE

	øext.	267	mm
	øint.	132	
		4,0	

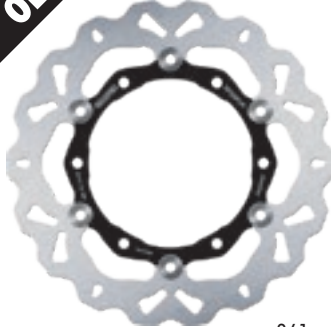

961 gr

GALFER
DF
531
W

OE

	øext.	240	mm
	øint.	115	
		4,0	



533 gr

GALFER
DF
534
W

OE

	øext.	230	mm
	øint.	115	
		4,0	



564 gr

GALFER
DF
526
W

OE

	øext.	292	mm
	øint.	155	
		4,0	



723 gr

GALFER
DF
531
RW

OE

	øext.	240	mm
	øint.	115	
		4,0	



526 gr

GALFER
DF
534
FLS

OE

	øext.	267	mm
	øint.	115	
		4,0	
			SP048

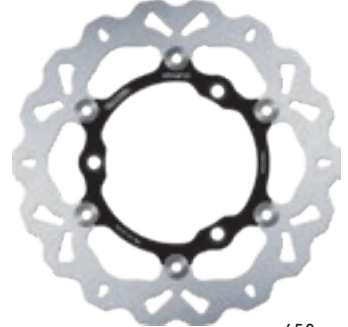

650 gr

GALFER
DF
527
W

OE

	øext.	230	mm
	øint.	102	
		4,0	



605 gr

GALFER
DF
532
W

OE

	øext.	245	mm
	øint.	115	
		4,0	



520 gr

GALFER
DF
535
W

OE

	øext.	230	mm
	øint.	121	
		4,5	



593 gr

OE: Original equipment (original replacement disc) - OE: Equipo original (disco de remplazo del original)

OE discs --> W - FLW - CW - V - FLV

Special discs --> WS - WLL - RW - RH - RWS - FLS - FLX - FRS - FRH - CRW - Q - FLQ



GALFER
DF
550
FLW **OE**

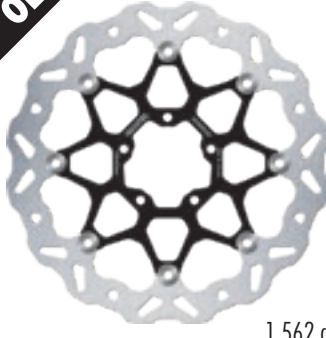

1.562 gr

	320 mm
	72
	5,0

GALFER
DF
606
RW



480 gr

	260 mm
	127
	3,0

GALFER
DF
606
RWSX



532 gr

	280 mm
	127
	3,0
	SP058

GALFER
DF
551
W **OE**



796 gr

	240 mm
	110
	5,0

GALFER
DF
606
WS



552 gr

	270 mm
	127
	3,0
	SP021/41

GALFER
DF
607
W **OE**



478 gr

	220 mm
	110
	4,0

GALFER
DF
552
W **OE**



1.433 gr

	300 mm
	64
	5,0

GALFER
DF
606
RWS



538 gr

	270 mm
	127
	3,0
	SP021/41

GALFER
DF
607
WLL

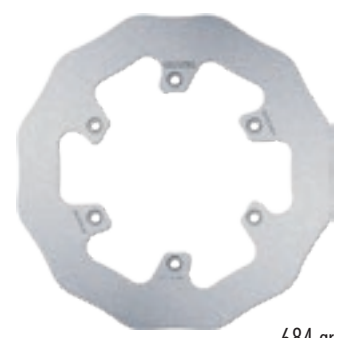

684 gr

	220 mm
	110
	4,5

GALFER
DF
606
W **OE**



456 gr

	260 mm
	127
	3,0

GALFER
DF
606
FLS



560 gr

	270 mm
	127
	3,0
	SP021/41

GALFER
DF
607
WS



582 gr

	240 mm
	110
	4,0
	SP043

Compatible with DF771W

GALFER
DF
606
FLW **OE**



556 gr

	260 mm
	127
	3,0

GALFER
DF
606
FRS

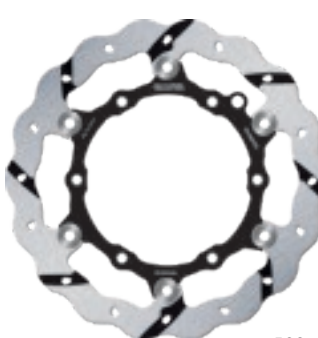

583 gr

	270 mm
	127
	3,0
	SP021/41

GALFER
DF
607
RW



480 gr

	220 mm
	110
	4,0



APPLICATIONS

PADS FD

DISCS DF

SHOES MF

LINES FK

BRACKETS SP

KITS KG

CROSS REFERENCE

GALFER
DF
607
RWS

	øext.	240
	mm	
	øint.	110
		4,0
		SP043



582 gr

GALFER
DF
624
W

	øext.	174
	mm	
	øint.	38
		3,0

OE



335 gr

GALFER
DF
629
FLS

	øext.	220
	mm	
	øint.	58
		3,0
		SP

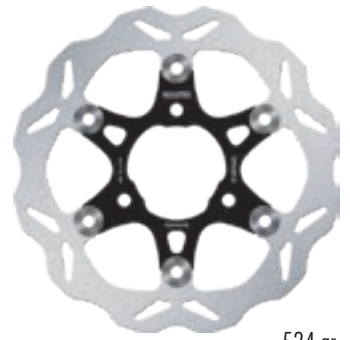

524 gr

GALFER
DF
609
W

	øext.	220
	mm	
	øint.	96
		3,5



486 gr

GALFER
DF
625
W

	øext.	174
	mm	
	øint.	66
		3,5

OE



405 gr

GALFER
DF
630
W

	øext.	220
	mm	
	øint.	108
		4,0



502 gr

GALFER
DF
612
W

	øext.	220
	mm	
	øint.	60
		4,0



571 gr

GALFER
DF
626
FLW

	øext.	260
	mm	
	øint.	120
		3,0

OE



635 gr

GALFER
DF
631
FLV

	øext.	305
	mm	
	øint.	118
		5,0
		0,0



1.584 gr

GALFER
DF
621
W

	øext.	240
	mm	
	øint.	90
		4,0



662 gr

GALFER
DF
629
W

	øext.	190
	mm	
	øint.	58
		3,8

OE



441 gr

GALFER
DF
631
CW

	øext.	305
	mm	
	øint.	118
		5,0
		0,0

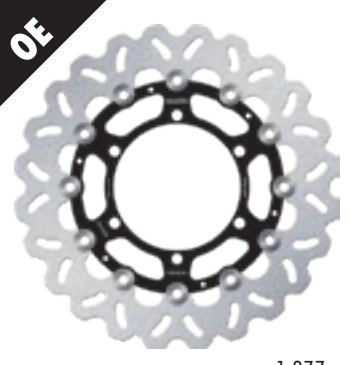

* UNTIL STOCKS END

1.377 gr

GALFER
DF
622
W

	øext.	220
	mm	
	øint.	90
		4,0



631 gr

GALFER
DF
629
RW

	øext.	190
	mm	
	øint.	58
		3,6

OE



* UNTIL STOCKS END

376 gr

GALFER
DF
632
W

	øext.	220
	mm	
	øint.	110
		4,0



538 gr



GALFER
DF
635
FLW
OE



531 gr

øext.	260 mm
øint.	120
	3,0
⌒	
👣	

GALFER
DF
638
W
OE



586 gr

øext.	220 mm
øint.	112
	4,0
⌒	
👣	

GALFER
DF
648
RW
OE



* UNTIL STOCKS END
421 gr

øext.	190 mm
øint.	68
	4,0
⌒	
👣	

GALFER
DF
635
FLS
OE



610 gr

øext.	270 mm
øint.	120
	3,0
⌒	
👣	SP021

GALFER
DF
639
W
OE



257 gr

øext.	160 mm
øint.	45
	3,0
⌒	
👣	

GALFER
DF
649
W
OE



460 gr

øext.	190 mm
øint.	58
	3,7
⌒	
👣	

GALFER
DF
635
FRS
OE



656 gr

øext.	270 mm
øint.	120
	3,0
⌒	
👣	SP021

GALFER
DF
642
W
OE



275 gr

øext.	155 mm
øint.	39
	3,0
⌒	
👣	

GALFER
DF
650
W
OE



493 gr

øext.	200 mm
øint.	98
	4,0
⌒	
👣	

GALFER
DF
636
W
OE



730 gr

øext.	245 mm
øint.	115
	4,5
⌒	
👣	

GALFER
DF
645
CW
OE

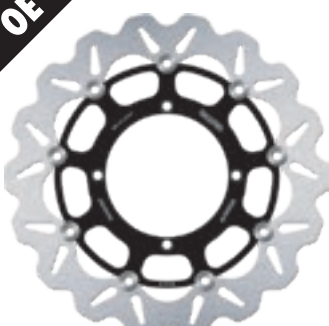

1.385 gr

øext.	320 mm
øint.	120
	5,0
⌒	9,0
👣	

GALFER
DF
650
RW
OE



431 gr

øext.	200 mm
øint.	98
	4,0
⌒	
👣	

GALFER
DF
637
W
OE



322 gr

øext.	198 mm
øint.	89
	3,0
⌒	
👣	

GALFER
DF
648
W
OE



428 gr

øext.	190 mm
øint.	68
	4,0
⌒	
👣	

GALFER
DF
651
CW
OE

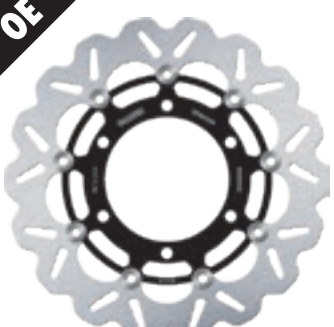

1.395 gr

øext.	310 mm
øint.	118
	5,0
⌒	12,5
👣	



APPLICATIONS

PADS FD

DISCS DF

SHOES MF

LINES FK

BRACKETS SP

KITS KG

CROSS REFERENCE

GALFER
DF
652
CW

OE

	296 mm
	118
	5,0
	12,5

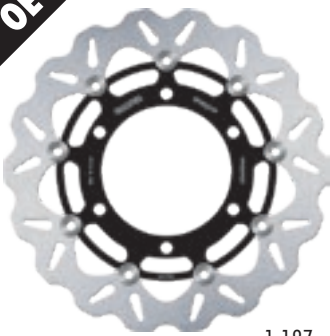

1.187 gr

GALFER
DF
660
CRW-I-D

	320 mm
	64
	5,0
	10,5

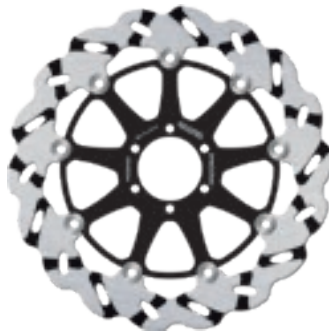

* UNTIL STOCKS END

1.370 gr

GALFER
DF
664
CW-I-D

OE

	300 mm
	105
	5,0
	0,0



* UNTIL STOCKS END

1.200 gr

GALFER
DF
653
CW

OE

	320 mm
	78
	5,0
	10,5

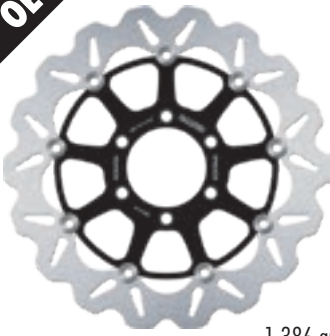

1.386 gr

GALFER
DF
661
CW

OE

	320 mm
	78
	4,5
	17,5

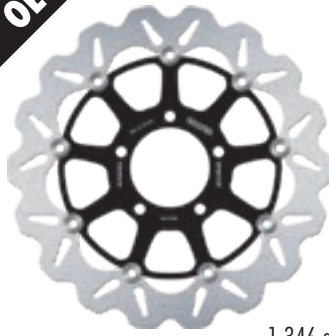

1.346 gr

GALFER
DF
666
W

OE

	240 mm
	125,5
	4,0



588 gr

GALFER
DF
655
CW

OE

	320 mm
	78
	5,0
	14,5

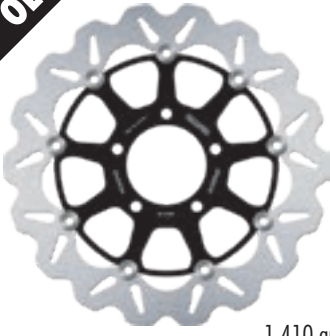

1.410 gr

GALFER
DF
662
W

OE

	285 mm
	164
	5,0



1.094 gr

GALFER
DF
667
W

OE

	260 mm
	125,5
	4,0



695 gr

GALFER
DF
658
W

OE

	240 mm
	108
	3,5

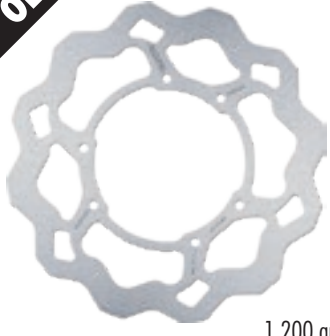

1.200 gr

GALFER
DF
663
FLW

OE

	298 mm
	105
	4,0



1.092 gr

GALFER
DF
668
W

OE

	172 mm
	64,4
	3,2



242 gr

GALFER
DF
660
CW

OE

	320 mm
	64
	5,0
	10,5

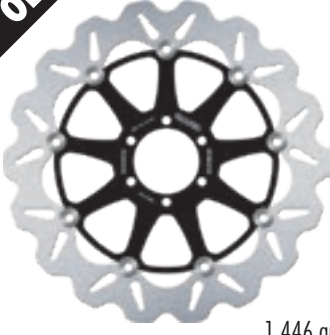

1.446 gr

GALFER
DF
664
FLV

OE

	300 mm
	105
	5,0
	0,0



1.656 gr

GALFER
DF
669
W

OE

	220 mm
	102
	4,0



567 gr

OE: Original equipment (original replacement disc) - OE: Equipo original (disco de remplazo del original)

OE discs --> W - FLW - CW - V - FLV

Special discs --> WS - WLL - RW - RH - RWS - FLS - FLX - FRS - FRH - CRW - Q - FLQ



GALFER
DF
669
WA

OE

	220
	mm
	102
	5,0



660 gr

GALFER
DF
672
FLW

OE

	300
	mm
	127
	4,0



960 gr

GALFER
DF
676
CW

OE

	296
	mm
	62
	5,0
	17,0

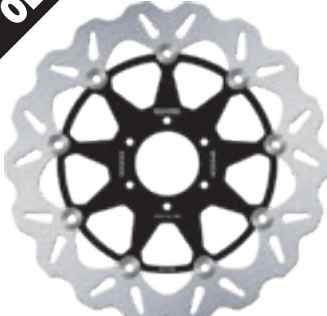

1.223 gr

GALFER
DF
670
W

OE

	240
	mm
	112
	4,0



552 gr

GALFER
DF
673
W

OE

	250
	mm
	108
	3,5



493 gr

GALFER
DF
677
W

OE

	260
	mm
	108
	3,5



606 gr

GALFER
DF
670
PW

OE

	240
	mm
	127
	4,0



517 gr

GALFER
DF
674
W

OE

	260
	mm
	108
	4,0



576 gr

GALFER
DF
677
FLW

OE

	260
	mm
	108
	3,0



650 gr

GALFER
DF
670
WLL

OE

	240
	mm
	112
	4,0



* UNTIL STOCKS END 600 gr

GALFER
DF
674
FLW

OE

	260
	mm
	108
	3,0



554 gr

GALFER
DF
677
FLS

OE

	270
	mm
	108
	3,0
	SP027



* UNTIL STOCKS END 580 gr

GALFER
DF
671
W

OE

	260
	mm
	60
	4,0



780 gr

GALFER
DF
675
W

OE

	200
	mm
	63
	4,0



357 gr

GALFER
DF
677
FRS

OE

	270
	mm
	108
	3,0
	SP027



702 gr



APPLICATIONS

PADS

DISCS

SHOES

LINES

BRACKETS

KITS

CROSS REFERENCE

GALFER
DF
677
CW

	øext.	320
	mm	
	øint.	108
		5,0
		0,0
		SP

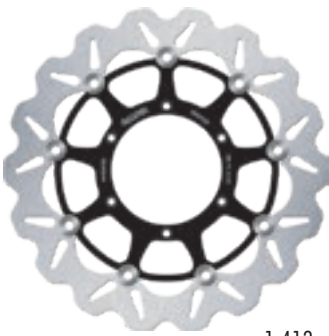

1.413 gr

GALFER
DF
679
W

	øext.	292
	mm	
	øint.	50,5
		5,0



1.491 gr

GALFER
DF
680
FLV

	øext.	292
	mm	
	øint.	56
		5,0

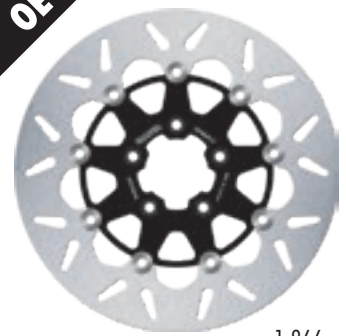

1.866 gr

GALFER
DF
678
W

	øext.	220
	mm	
	øint.	108
		4,0



403 gr

GALFER
DF
679
FLV

	øext.	292
	mm	
	øint.	50,5
		5,0



1.880 gr

GALFER
DF
680
FLW

	øext.	292
	mm	
	øint.	56
		5,0

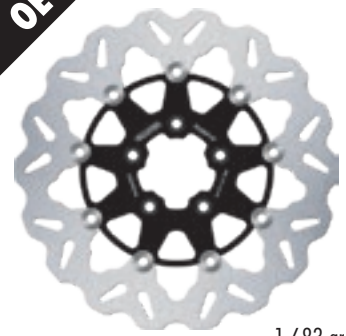

1.683 gr

GALFER
DF
678
WLL

	øext.	220
	mm	
	øint.	108
		4,0



483 gr

GALFER
DF
679
FLW

	øext.	292
	mm	
	øint.	50,5
		5,0

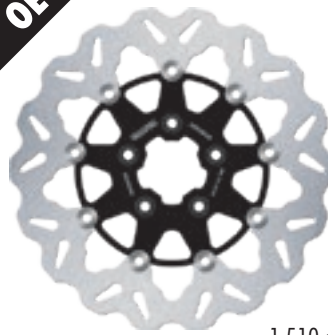

1.510 gr

GALFER
DF
680
RH

	øext.	292
	mm	
	øint.	56
		5,0



1.415 gr

GALFER
DF
678
WS

	øext.	240
	mm	
	øint.	108
		4,0



* UNTIL STOCKS END

647 gr

GALFER
DF
680
V

	øext.	292
	mm	
	øint.	56
		5,0



1.787 gr

GALFER
DF
680
FRH

	øext.	292
	mm	
	øint.	56
		5,0



1.667 gr

GALFER
DF
679
V

	øext.	292
	mm	
	øint.	50,5
		5,0



1.678 gr

GALFER
DF
680
W

	øext.	292
	mm	
	øint.	56
		5,0



1.538 gr

GALFER
DF
680
Q

	øext.	292
	mm	
	øint.	56
		5,0



1.286 gr



GALFER DF 680 FLQ

	292 mm
	56
	5,0

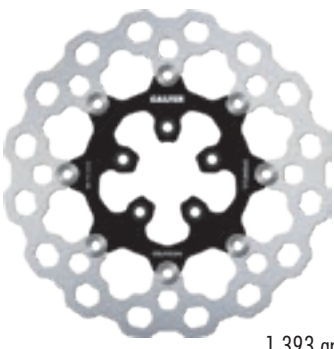

1.393 gr

GALFER DF 681 RH **OE**

	292 mm
	56
	6,4



2.078 gr

GALFER DF 682 RH **OE**

	292 mm
	50,5
	5,0

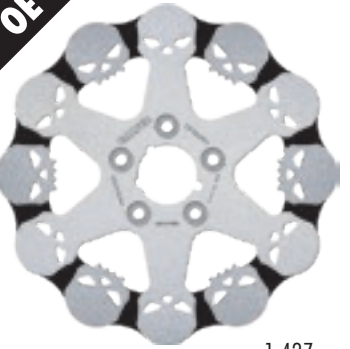

1.427 gr

GALFER DF 681 V **OE**

	292 mm
	56
	6,4



2.159 gr

GALFER DF 681 FRH **OE**

	292 mm
	56
	5,0



1.515 gr

GALFER DF 683 W **OE**

	280 mm
	108
	4,0



882 gr

GALFER DF 681 W **OE**

	292 mm
	56
	6,4



1.951 gr

GALFER DF 681 Q **OE**

	292 mm
	56
	6,4



1.658 gr

GALFER DF 684 W **OE**

	220 mm
	57
	4,0



686 gr

GALFER DF 681 FLV **OE**

	292 mm
	56
	5,0



1.853 gr

GALFER DF 682 V **OE**

	292 mm
	50,5
	5,0



1.760 gr

GALFER DF 685 W **OE**

	219 mm
	95
	3,0



350 gr

GALFER DF 681 FLW **OE**

	292 mm
	56
	5,0

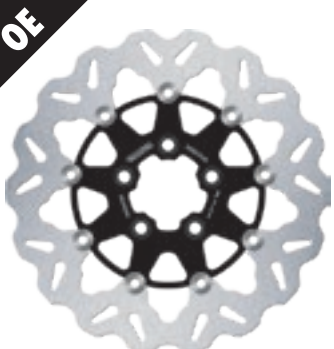

1.670 gr

GALFER DF 682 W **OE**

	292 mm
	50,5
	5,0



1.525 gr

GALFER DF 686 W **OE**

	201 mm
	110
	3,0



250 gr



APPLICATIONS

PADS FD

DISCS DF

SHOES MF

LINES FK

BRACKETS SP

KITS KG

CROSS REFERENCE

GALFER
DF
688
W

OE

	øext.	198
	mm	
	øint.	89
		3,0



314 gr

GALFER
DF
692
CW

OE

	øext.	310
	mm	
	øint.	58
		5,0
		17,0



1.404 gr

GALFER
DF
701
V

OE

	øext.	276
	mm	
	øint.	174
		5,0

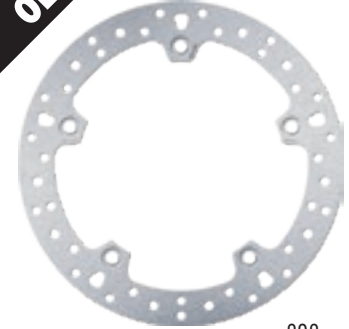

898 gr

GALFER
DF
689
W

OE

	øext.	160
	mm	
	øint.	45
		3,0



234 gr

GALFER
DF
698
W

OE

	øext.	218
	mm	
	øint.	62
		3,5



479 gr

GALFER
DF
701
W

OE

	øext.	276
	mm	
	øint.	174
		5,0



831 gr

* UNTIL STOCKS END

GALFER
DF
690
CW

OE

	øext.	310
	mm	
	øint.	64
		5,0
		22,5

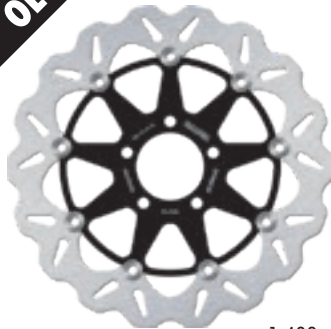

1.432 gr

GALFER
DF
699
W

OE

	øext.	290
	mm	
	øint.	108
		3,5



862 gr

GALFER
DF
702
V

OE

	øext.	305
	mm	
	øint.	181
		4,5

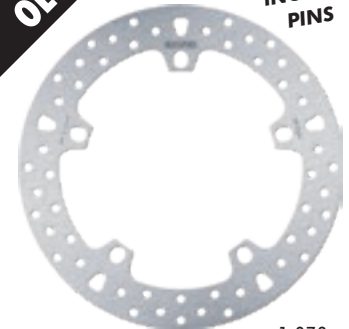

1.078 gr

INCLUDE PINS

GALFER
DF
691
FLW

OE

	øext.	254
	mm	
	øint.	50,5
		5,0



1.267 gr

GALFER
DF
699
FLW

OE

	øext.	290
	mm	
	øint.	108
		4,0



1.010 gr

GALFER
DF
702
W

OE

	øext.	305
	mm	
	øint.	181
		4,5



951 gr

INCLUDE PINS

* UNTIL STOCKS END

GALFER
DF
691
RH

OE

	øext.	254
	mm	
	øint.	50,5
		5,0



1.215 gr

GALFER
DF
700
W

OE

	øext.	180
	mm	
	øint.	62
		3,5



383 gr

GALFER
DF
703
W

OE

	øext.	240
	mm	
	øint.	110
		5,0



719 gr

OE: Original equipment (original replacement disc) - OE: Equipo original (disco de reemplazo del original)

OE discs --> W - FLW - CW - V - FLV

Special discs --> WS - WLL - RW - RH - RWS - FLS - FLX - FRS - FRH - CRW - Q - FLQ



GALFER DF 704 W **OE**



503 gr

øext.	220 mm
øint.	105
	4,0
⌒	
👣	

GALFER DF 707 W **OE** **INCLUDE PINS**



1.031 gr

* UNTIL STOCKS END

øext.	320 mm
øint.	181
	4,5
⌒	
👣	

GALFER DF 711 WLL **OE**



620 gr

* UNTIL STOCKS END

øext.	220 mm
øint.	102
	4,0
⌒	
👣	

GALFER DF 704 FLW **OE**

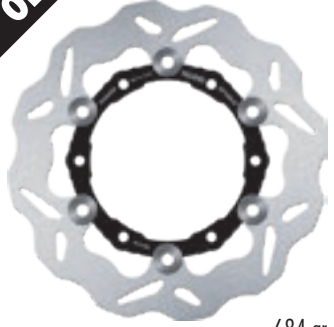

684 gr

øext.	220 mm
øint.	105
	4,0
⌒	
👣	

GALFER DF 708 Wl-D **OE**

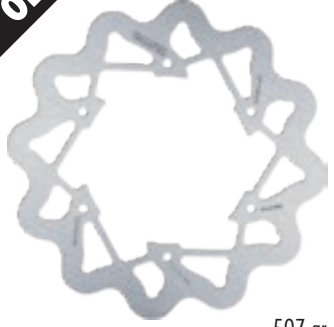

507 gr

øext.	240 mm
øint.	125
	3,5
⌒	
👣	

GALFER DF 712 W **OE**



220 gr

øext.	174 mm
øint.	56
	3,0
⌒	
👣	

GALFER DF 705 W **OE**



370 gr

øext.	175 mm
øint.	73
	4,0
⌒	
👣	

GALFER DF 709 W **OE**



537 gr

øext.	218 mm
øint.	57
	3,5
⌒	
👣	

GALFER DF 713 W **OE**



341 gr

øext.	187 mm
øint.	72
	4,0
⌒	
👣	

GALFER DF 706 W **OE**



635 gr

øext.	240 mm
øint.	107
	4,0
⌒	
👣	

GALFER DF 710 FLW **OE**

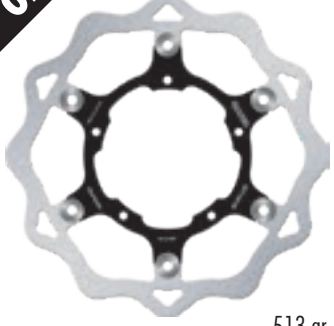

513 gr

øext.	260 mm
øint.	105,5
	3,0
⌒	
👣	

GALFER DF 714 W **OE**



646 gr

øext.	240 mm
øint.	105
	4,0
⌒	
👣	

GALFER DF 707 V **OE** **INCLUDE PINS**

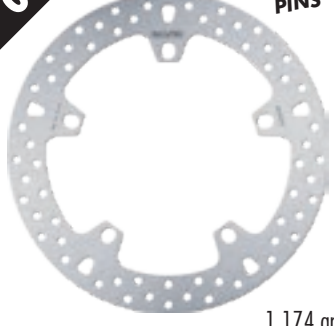

1.174 gr

øext.	320 mm
øint.	181
	4,5
⌒	
👣	

GALFER DF 711 W **OE**



565 gr

øext.	220 mm
øint.	102
	4,0
⌒	
👣	

GALFER DF 715 W **OE**



624 gr

øext.	220 mm
øint.	50
	4,0
⌒	
👣	



APPLICATIONS

PADS FD

DISCS DF

SHOES MF

LINES FK

BRACKETS SP

KITS KG

CROSS REFERENCE

GALFER
DF
716
W

OE

	øext.	218,5	mm
	øint.	110,5	
		4,4	



456 gr

GALFER
DF
720
W

OE

	øext.	276	mm
	øint.	136,5	
		5,0	



* UNTIL STOCKS END

976 gr

GALFER
DF
724
W

OE

	øext.	260	mm
	øint.	56	
		6,0	



1.444 gr

GALFER
DF
717
W

OE

	øext.	165	mm
	øint.	51	
		4,4	



458 gr

GALFER
DF
721
W

OE

	øext.	260	mm
	øint.	105	
		4,0	



731 gr

GALFER
DF
724
FLW

OE

	øext.	260	mm
	øint.	56	
		6,0	



1.533 gr

GALFER
DF
718
W

OE

	øext.	218,5	mm
	øint.	121,5	
		4,0	



540 gr

GALFER
DF
722
W

OE

	øext.	183	mm
	øint.	73	
		4,0	



342 gr

GALFER
DF
724
RH

OE

	øext.	260	mm
	øint.	56	
		6,0	



1.450 gr

GALFER
DF
719
W

OE

	øext.	165	mm
	øint.	48,5	
		4,0	



350 gr

GALFER
DF
723
W

OE

	øext.	202	mm
	øint.	95	
		3,5	



378 gr

GALFER
DF
724
Q

OE

	øext.	260	mm
	øint.	56	
		6,0	



1.286 gr

GALFER
DF
720
V

OE

	øext.	276	mm
	øint.	136,5	
		5,0	

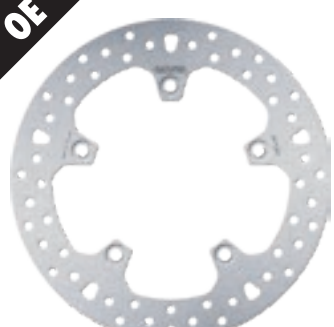

1.080 gr

GALFER
DF
724
V

OE

	øext.	260	mm
	øint.	56	
		6,0	



1.792 gr

GALFER
DF
725
W

OE

	øext.	177	mm
	øint.	51,7	
		4,5	



422 gr



GALFER DF 726 W **OE**

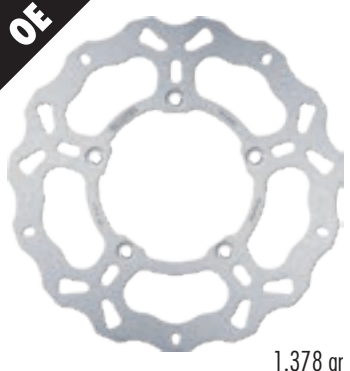

øext.	320 mm
øint.	136
	5,0
⌒	
👣	

1.378 gr

GALFER DF 732 W **OE**



øext.	200 mm
øint.	51,5
	3,6
⌒	
👣	

430 gr

GALFER DF 738 W **OE**



øext.	280 mm
øint.	90
	4,0
⌒	
👣	

953 gr

GALFER DF 727 W **OE**



øext.	196 mm
øint.	81,3
	4,0
⌒	
👣	

490 gr

GALFER DF 733 W **OE**



øext.	160 mm
øint.	48
	3,1
⌒	
👣	

240 gr

GALFER DF 742 W **OE**



øext.	180 mm
øint.	54
	5,0
⌒	
👣	

535 gr

GALFER DF 729 W **OE**



øext.	160 mm
øint.	48
	4,9
⌒	
👣	

496 gr

GALFER DF 734 W **OE**



øext.	190 mm
øint.	78,5
	4,0
⌒	
👣	

398 gr

GALFER DF 743 W **OE**



øext.	220 mm
øint.	108
	4,5
⌒	
👣	

585 gr

GALFER DF 730 W **OE**



øext.	199 mm
øint.	51,2
	3,5
⌒	
👣	

384 gr

GALFER DF 736 W **OE**



øext.	255 mm
øint.	115
	5,0
⌒	
👣	

923 gr

GALFER DF 744 W **OE**



øext.	260 mm
øint.	72
	3,2
⌒	
👣	

537 gr

GALFER DF 731 W **OE**



øext.	163 mm
øint.	51,7
	3,5
⌒	
👣	

272 gr

GALFER DF 737 W **OE**



øext.	220 mm
øint.	58
	4,0
⌒	
👣	

618 gr

GALFER DF 745 W **OE**



øext.	200 mm
øint.	45
	3,5
⌒	
👣	

474 gr



APPLICATIONS

PADS FD

DISCS DF

SHOES MF

LINES FK

BRACKETS SP

KITS KG

CROSS REFERENCE

GALFER
DF
747
W

	øext.	202	mm
	øint.	75,5	
		4,8	



GALFER
DF
755
CW-I-D

	øext.	320	mm
	øint.	179	
		5,0	

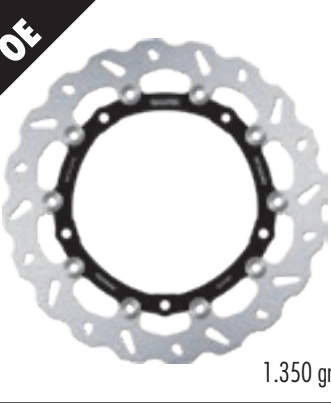

GALFER
DF
763
V

	øext.	265	mm
	øint.	136	
		5,0	

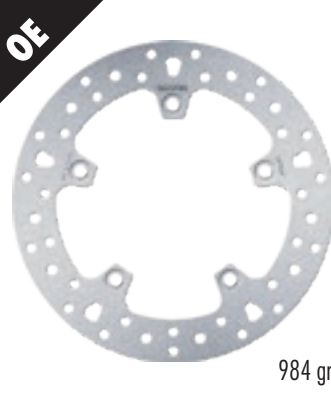

GALFER
DF
748
W

	øext.	216	mm
	øint.	75,5	
		4,0	



GALFER
DF
756
W

	øext.	220	mm
	øint.	120	
		5,0	



GALFER
DF
763
W

	øext.	265	mm
	øint.	136	
		5,0	



GALFER
DF
749
W

	øext.	220	mm
	øint.	75,5	
		5,0	



GALFER
DF
758
W

	øext.	200	mm
	øint.	63	
		4,0	



GALFER
DF
765
CW

	øext.	310	mm
	øint.	80	
		5,0	
		10,0	



GALFER
DF
751
W

	øext.	290	mm
	øint.	109	
		4,0	

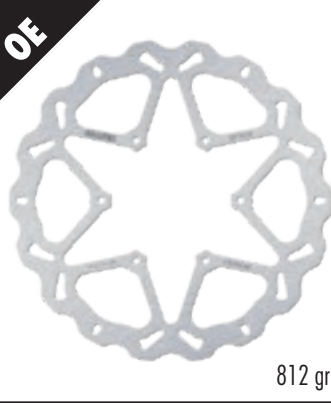

GALFER
DF
758
WU

	øext.	200	mm
	øint.	63	
		4,0	



GALFER
DF
766
W

	øext.	210	mm
	øint.	108	
		5,0	



GALFER
DF
752
W

	øext.	250	mm
	øint.	109	
		4,0	



GALFER
DF
759
W

	øext.	300	mm
	øint.	108	
		4,0	

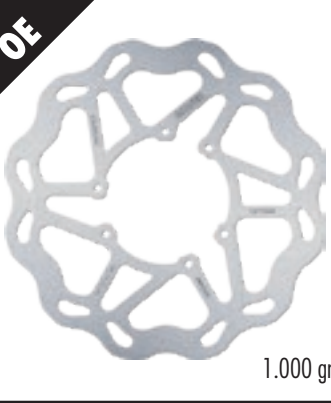

GALFER
DF
767
W

	øext.	240	mm
	øint.	113	
		4,0	





GALFER DF 768 W **OE**



øext.	320 mm
øint.	176,5
	4,5
⌒	
👣	

1.015 gr

GALFER DF 772 FLW **OE**



øext.	270 mm
øint.	120
	3,0
⌒	
👣	

529 gr
SP047: for Sherco WP/KYB fork models from 2014

GALFER DF 774 FLQ

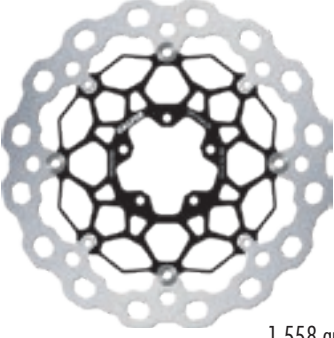

øext.	330 mm
øint.	72
	5,0
⌒	15,0
👣	

1.558 gr

GALFER DF 769 W **OE**



øext.	245 mm
øint.	108
	5,0
⌒	
👣	

818 gr

GALFER DF 772 FRW

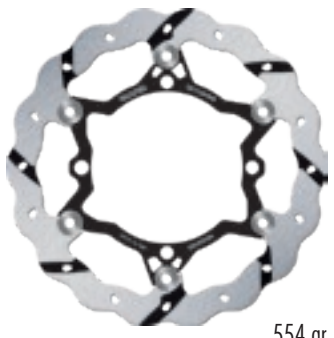

øext.	270 mm
øint.	120
	3,0
⌒	
👣	

554 gr
SP047: for Sherco WP fork models from 2014

GALFER DF 775 W **OE**



øext.	245 mm
øint.	83
	5,0
⌒	
👣	

840 gr

GALFER DF 770 W **OE**

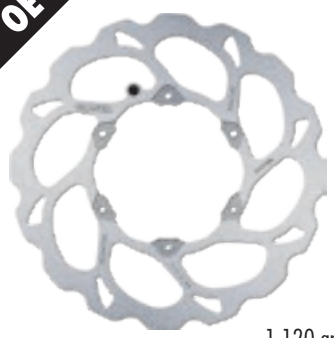

øext.	300 mm
øint.	127
	5,0
⌒	
👣	

1.120 gr

GALFER DF 773 CW **OE**

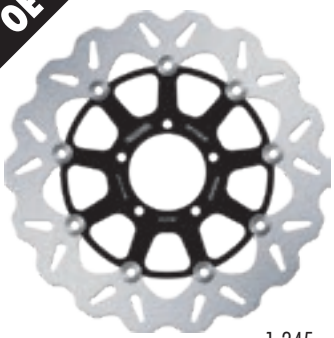

øext.	305 mm
øint.	72
	4,5
⌒	9,75
👣	

1.245 gr

GALFER DF 775 Q

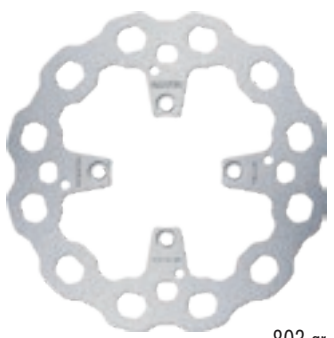

øext.	245 mm
øint.	83
	5,0
⌒	
👣	

803 gr

GALFER DF 770 FLW **OE**



øext.	300 mm
øint.	124,4
	5,0
⌒	
👣	

1.388 gr

GALFER DF 774 CW I-D **OE**

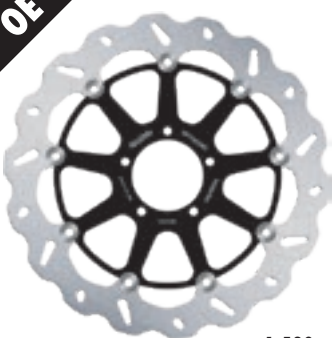

øext.	330 mm
øint.	72
	5,0
⌒	15,0
👣	

1.520 gr

GALFER DF 777 W **OE**



øext.	219 mm
øint.	95
	3,0
⌒	
👣	

355 gr

GALFER DF 771 W **OE**



øext.	240 mm
øint.	109
	4,0
⌒	
👣	

Compatible with DF607WS
573 gr

GALFER DF 774 CRW

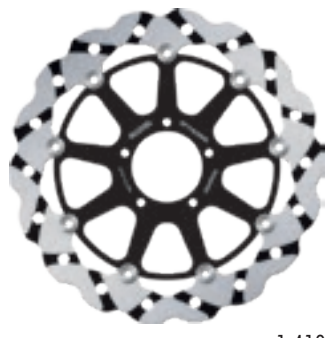

øext.	330 mm
øint.	72
	5,0
⌒	15,0
👣	

* UNTIL STOCKS END
1.410 gr

GALFER DF 778 W **OE**



øext.	201,5 mm
øint.	110
	4,0
⌒	
👣	

325 gr



APPLICATIONS

PADS FD

DISCS DF

SHOES MF

LINES FK

BRACKETS SP

KITS KG

CROSS REFERENCE

GALFER
DF
779
W

	øext.	160	mm
	øint.	72	
		2,5	



GALFER
DF
784
FLW

	øext.	220	mm
	øint.	88,7	
		5,0	

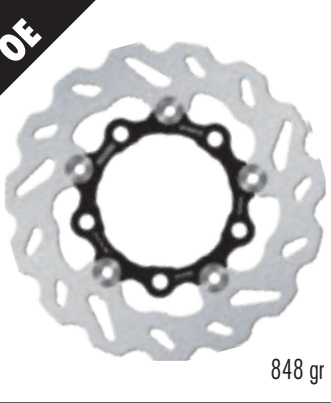

GALFER
DF
789
CW

	øext.	280	mm
	øint.	60	
		4,0	

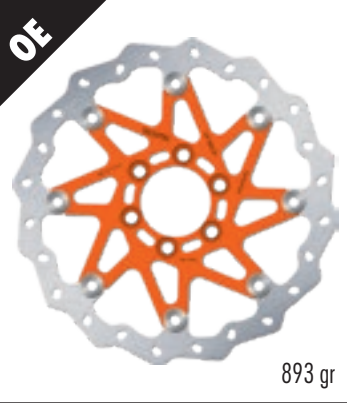

GALFER
DF
780
W

	øext.	140	mm
	øint.	45	
		2,7	



GALFER
DF
785
CW

	øext.	320	mm
	øint.	136	
		5,0	



GALFER
DF
790
W

	øext.	230	mm
	øint.	104	
		4,0	



GALFER
DF
782
FLW

	øext.	240	mm
	øint.	110	
		5,0	

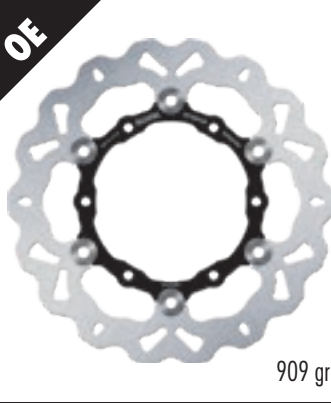

GALFER
DF
786
FLW

	øext.	240	mm
	øint.	107	
		5,0	

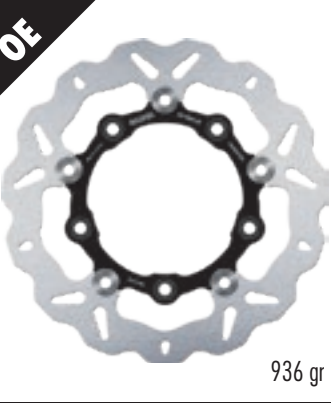

GALFER
DF
793
FLW

	øext.	267	mm
	øint.	110	
		5,0	

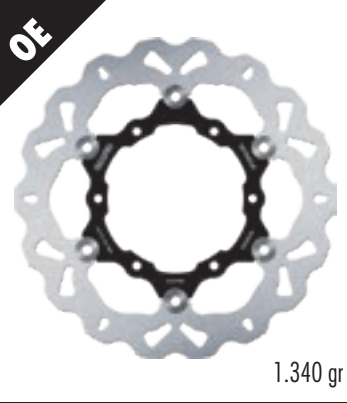

GALFER
DF
783
CW-I-D

	øext.	320	mm
	øint.	64	
		5,0	
		10,0	

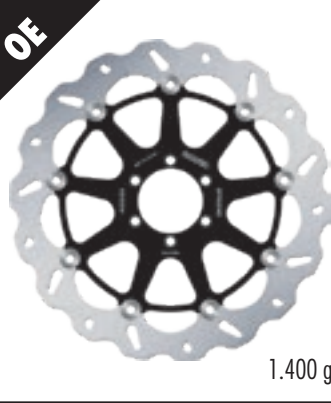

GALFER
DF
787
CWI

	øext.	320	mm
	øint.	52	
		5,0	



GALFER
DF
794
W

	øext.	240	mm
	øint.	95	
		3,0	



GALFER
DF
784
W

	øext.	220	mm
	øint.	88,7	
		5,0	



GALFER
DF
788
W

	øext.	240	mm
	øint.	86	
		5,0	



GALFER
DF
794
RWS

	øext.	260	mm
	øint.	95	
		3,0	
		SP794	



OE: Original equipment (original replacement disc) - OE: Equipo original (disco de remplazo del original)

OE discs --> W - FLW - CW - V - FLV

Special discs --> WS - WLL - RW - RH - RWS - FLS - FLX - FRS - FRH - CRW - Q - FLQ



GALFER DF 795 W **OE**

øext.	230 mm
øint.	109
	4,0
⌒	
👣	



547 gr

GALFER DF 800 CW **OE**

øext.	300 mm
øint.	60
	5,0
⌒	
👣	

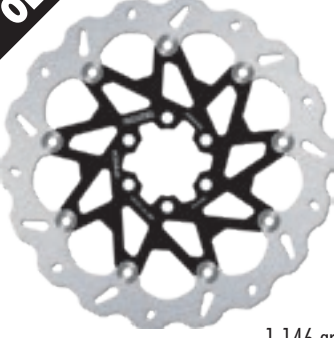

1.146 gr

GALFER DF 805 W **OE**

øext.	165 mm
øint.	49,5
	3,0
⌒	
👣	



254 gr

GALFER DF 796 W **OE**

øext.	260 mm
øint.	95
	3,0
⌒	
👣	



567 gr

GALFER DF 801 CW **OE**

øext.	300 mm
øint.	52
	5,0
⌒	
👣	

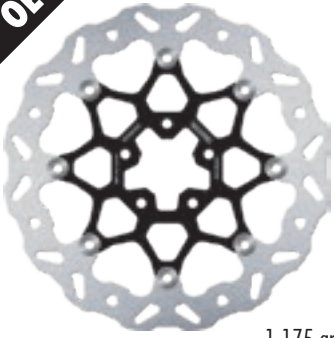

1.175 gr

GALFER DF 806 W **OE**

øext.	240 mm
øint.	107
	5,0
⌒	
👣	



762 gr

GALFER DF 797 W **OE**

øext.	210 mm
øint.	109
	4,0
⌒	
👣	



407 gr

GALFER DF 801 FLQ **OE**

øext.	300 mm
øint.	52
	5,0
⌒	
👣	

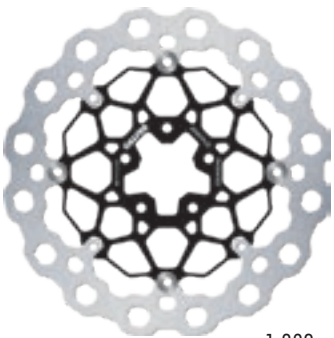

1.382 gr

GALFER DF 806 Q **OE**

øext.	240 mm
øint.	107
	5,0
⌒	
👣	

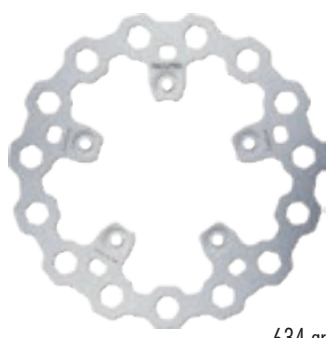

634 gr

GALFER DF 797 WS **OE**

øext.	220 mm
øint.	109
	4,0
⌒	
👣	SP



483 gr

GALFER DF 803 W **OE**

øext.	130 mm
øint.	45
	3,0
⌒	
👣	



160 gr

GALFER DF 807 CW **OE**

øext.	320 mm
øint.	72
	4,5
⌒	9,75
👣	

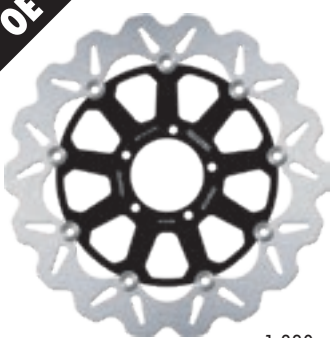

1.320 gr

GALFER DF 798 W **OE**

øext.	240 mm
øint.	107
	4,0
⌒	
👣	



580 gr

GALFER DF 804 W **OE**

øext.	185 mm
øint.	71,5
	3,5
⌒	
👣	



260 gr

GALFER DF 808 W **OE**

øext.	184 mm
øint.	70,5
	2,9
⌒	
👣	



258 gr

APPLICATIONS

PADS **FD**

DISCS **DF**

SHOES **MF**

LINES **FK**

BRACKETS **SP**

KITS **KG**

CROSS REFERENCE



APPLICATIONS

PADS FD

DISCS DF

SHOES MF

LINES FK

BRACKETS SP

KITS KG

CROSS REFERENCE

GALFER
DF
809
W

OE

	øext.	150 mm
	øint.	45,5
		2,9



191 gr

GALFER
DF
814
RW

	øext.	260 mm
	øint.	127
		3,0



458 gr

GALFER
DF
816
W

OE

	øext.	270 mm
	øint.	149,5
		5,0



879 gr

GALFER
DF
809
WLLG

OE

	øext.	150 mm
	øint.	45,5
		2,9



380 gr

GALFER
DF
814
FRW

	øext.	260 mm
	øint.	127
		3,0

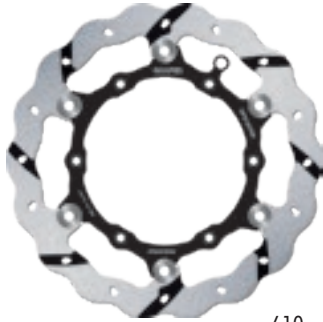

610 gr

GALFER
DF
816
FLW

OE

	øext.	270 mm
	øint.	149,5
		5,0

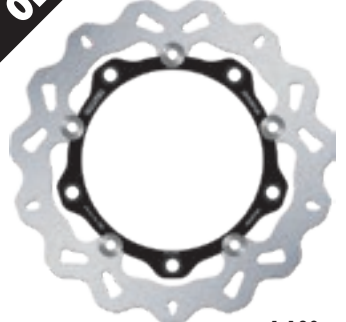

1.120 gr

GALFER
DF
811
W

OE

	øext.	280 mm
	øint.	90
		4,0



778 gr

GALFER
DF
815
W

OE

	øext.	240 mm
	øint.	109
		4,0



521 gr

GALFER
DF
817
CW1-D

OE

	øext.	320 mm
	øint.	64
		5,0

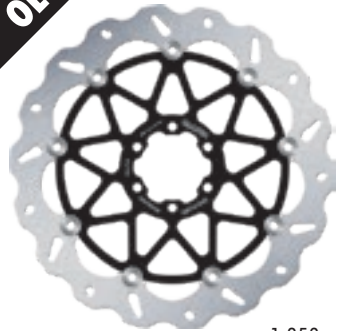

1.358 gr

GALFER
DF
812
W

OE

	øext.	265 mm
	øint.	83,5
		6,0



1.270 gr

GALFER
DF
815
WLL

	øext.	240 mm
	øint.	109
		4,0



628 gr

GALFER
DF
818
W

OE

	øext.	184,5 mm
	øint.	77
		2,7



228 gr

GALFER
DF
814
W

OE

	øext.	260 mm
	øint.	127
		3,0



478 gr

GALFER
DF
815
RW

	øext.	240 mm
	øint.	109
		4,0



600 gr

GALFER
DF
819
W

OE

	øext.	159 mm
	øint.	45
		2,7



170 gr

OE: Original equipment (original replacement disc) - OE: Equipo original (disco de remplazo del original)

OE discs --> W - FLW - CW - V - FLV

Special discs --> WS - WLL - RW - RH - RWS - FLS - FLX - FRS - FRH - CRW - Q - FLQ



GALFER
DF
819
WLLG

OE



380 gr

øext.	159 mm
øint.	45
	3,0
⌒	
👣	

GALFER
DF
822
FLV

OE



1.774 gr

øext.	300 mm
øint.	101,5
	5,6
⌒	6,3
👣	

GALFER
DF
823
PW

OE



1.057 gr

øext.	292 mm
øint.	172
	5,0
⌒	
👣	

GALFER
DF
820
W

OE



1.240 gr

øext.	375 mm
øint.	307,5
	5,0
⌒	
👣	

GALFER
DF
822
FLW

OE



1.572 gr

øext.	300 mm
øint.	101,5
	5,6
⌒	6,3
👣	

GALFER
DF
824
FLV

OE



1.810 gr

øext.	260 mm
øint.	56
	6,0
⌒	
👣	

GALFER
DF
821
PV

OE



1.122 gr

øext.	300 mm
øint.	172
	5,0
⌒	
👣	

GALFER
DF
822
CW

OE



* UNTIL STOCKS END 1.522 gr

øext.	300 mm
øint.	101,5
	5,6
⌒	6,3
👣	

GALFER
DF
824
FLW

OE



1.686 gr

øext.	292 mm
øint.	101,5
	5,6
⌒	
👣	

GALFER
DF
821
PW

OE



1.020 gr

øext.	300 mm
øint.	172
	5,0
⌒	
👣	

GALFER
DF
822
FLQ

OE



1.493 gr

øext.	300 mm
øint.	101,5
	5,6
⌒	6,3
👣	

GALFER
DF
824
CW

OE



* UNTIL STOCKS END 1.400 gr

øext.	292 mm
øint.	101,5
	5,6
⌒	
👣	

GALFER
DF
821
PQ

OE

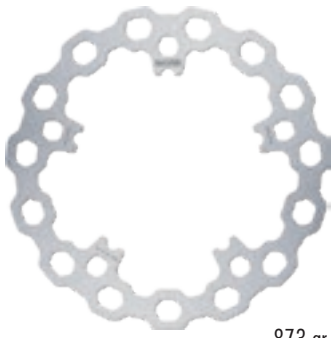

873 gr

øext.	300 mm
øint.	172
	5,0
⌒	
👣	

GALFER
DF
823
PV

OE



1.162 gr

øext.	292 mm
øint.	172
	5,0
⌒	
👣	

GALFER
DF
825
CW I-D

OE

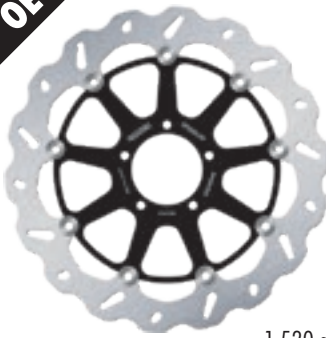

1.520 gr

øext.	330 mm
øint.	72
	5,0
⌒	10,0
👣	



APPLICATIONS

PADS

DISCS

SHOES

LINES

BRACKETS

KITS

CROSS REFERENCE

GALFER
DF
826
CW

OE

	øext.	320
	mm	
	øint.	105
		5,0
	∩	0,0
	∩	SP



1.400 gr

GALFER
DF
828
RW

	øext.	270
	mm	
	øint.	70,5
		3,0
	∩	
	∩	



510 gr

GALFER
DF
830
CW

OE

	øext.	320
	mm	
	øint.	80
		5,0
	∩	
	∩	

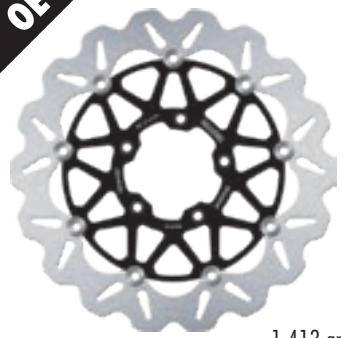

1.413 gr

GALFER
DF
826
CRWI

	øext.	320
	mm	
	øint.	105
		5,0
	∩	0,0
	∩	SP

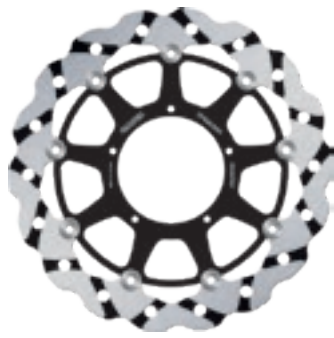

* UNTIL STOCKS END

1.325 gr

GALFER
DF
828
FRW

	øext.	270
	mm	
	øint.	70,5
		3,0
	∩	
	∩	

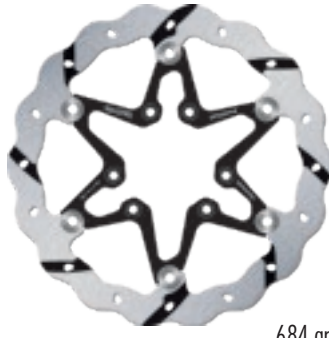

684 gr

GALFER
DF
831
W

OE

	øext.	220
	mm	
	øint.	108
		5,0
	∩	
	∩	



720 gr

GALFER
DF
827
W

OE

	øext.	240
	mm	
	øint.	102
		4,0
	∩	
	∩	



621 gr

GALFER
DF
829
W

OE

	øext.	243
	mm	
	øint.	114
		4,0
	∩	
	∩	



564 gr

GALFER
DF
832
W

OE

	øext.	240
	mm	
	øint.	64,5
		3,0
	∩	
	∩	



450 gr

GALFER
DF
828
W

OE

	øext.	270
	mm	
	øint.	70,5
		3,0
	∩	
	∩	



533 gr

GALFER
DF
829
WLL

	øext.	243
	mm	
	øint.	114
		4,0
	∩	
	∩	



665 gr

GALFER
DF
833
W

OE

	øext.	190
	mm	
	øint.	95,5
		3,5
	∩	
	∩	



370 gr

GALFER
DF
828
FLW

OE

	øext.	270
	mm	
	øint.	70,5
		3,0
	∩	
	∩	



632 gr

GALFER
DF
829
RW

	øext.	243
	mm	
	øint.	114
		4,0
	∩	
	∩	



630 gr

GALFER
DF
834
FLV

OE

	øext.	300
	mm	
	øint.	144
		5,0
	∩	
	∩	









1.485 gr



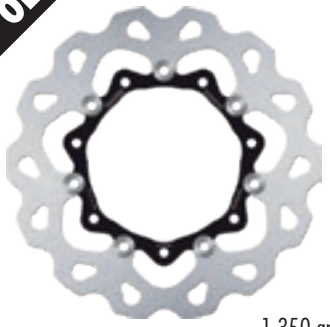



OE: Original equipment (original replacement disc) - OE: Equipo original (disco de remplazo del original)

OE discs --> W - FLW - CW - V - FLV

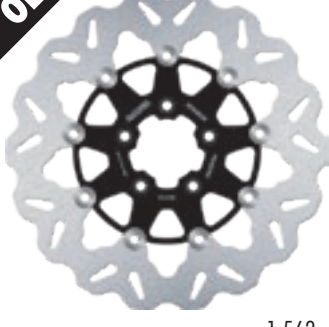





Special discs --> WS - WLL - RW - RH - RWS - FLS - FLX - FRS - FRH - CRW - Q - FLQ















GALFER	DF	834	FLW	OE		1.350 gr
	øext.	300	mm			
	øint.	144				
		5,0				
						
						







GALFER	DF	835	CW	OE		1.562 gr
	øext.	300	mm			
	øint.	56				
		5,0				
						
						







* UNTIL STOCKS END







GALFER	DF	836	FLV	OE		1.927 gr
	øext.	300	mm			
	øint.	56				
		5,0				
						
						







GALFER	DF	835	V	OE		1.781 gr
	øext.	300	mm			
	øint.	56				
		5,0				
						
						







GALFER	DF	835	RH	OE		1.700 gr
	øext.	300	mm			
	øint.	56				
		5,0				
						
						







GALFER	DF	836	FLW	OE		1.802 gr
	øext.	300	mm			
	øint.	56				
		5,0				
						
						







GALFER	DF	835	W	OE		1.650 gr
	øext.	300	mm			
	øint.	56				
		5,0				
						
						







GALFER	DF	835	FRH	OE		1.850 gr
	øext.	300	mm			
	øint.	56				
		5,0				
						
						







GALFER	DF	836	RH	OE		1.700 gr
	øext.	300	mm			
	øint.	56				
		5,0				
						
						







GALFER	DF	835	FLV	OE		1.940 gr
	øext.	300	mm			
	øint.	56				
		5,0				
						
						

GALFER	DF	835	Q	OE		1.323 gr
	øext.	300	mm			
	øint.	56				
		5,0				
						
						

GALFER	DF	836	FRH	OE		1.850 gr
	øext.	300	mm			
	øint.	56				
		5,0				
						
						

GALFER	DF	835	FLW	OE		1.815 gr
	øext.	300	mm			
	øint.	56				
		5,0				
						
						

GALFER	DF	835	FLQ	OE		1.430 gr
	øext.	300	mm			
	øint.	56				
		5,0				
						
						

GALFER	DF	836	Q	OE		1.323 gr
	øext.	300	mm			
	øint.	56				
		5,0				
						
						



APPLICATIONS

PADS

DISCS

SHOES

LINES

BRACKETS

KITS

CROSS REFERENCE

GALFER
DF
836
FLQ

	øext.	300
	mm	
	øint.	56
		5,0



1.423 gr

GALFER
DF
840
WLL

	øext.	240
	mm	
	øint.	114
		4,0



580 gr

GALFER
DF
845
CW

	øext.	320
	mm	
	øint.	60
		5,0

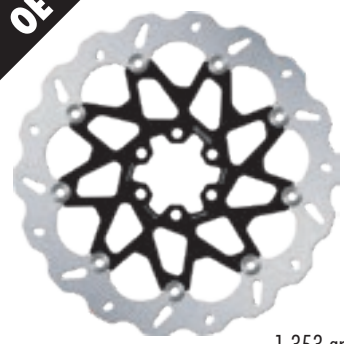

1.353 gr

GALFER
DF
838
V

	øext.	300
	mm	
	øint.	138,5
		5,0



1.415 gr

GALFER
DF
840
RW

	øext.	240
	mm	
	øint.	114
		4,0



530 gr

GALFER
DF
846
FLW

	øext.	320
	mm	
	øint.	127
		4,5



1.469 gr

GALFER
DF
838
W

	øext.	300
	mm	
	øint.	138,5
		5,0



1.287 gr

GALFER
DF
841
W

	øext.	200
	mm	
	øint.	72
		3,5



412 gr

GALFER
DF
846
FLWB

	øext.	320
	mm	
	øint.	127
		4,5



1.458 gr

GALFER
DF
839
W

	øext.	245
	mm	
	øint.	83
		5,0



820 gr

GALFER
DF
842
W

	øext.	165
	mm	
	øint.	46
		5,0



479 gr

GALFER
DF
846
CW

	øext.	320
	mm	
	øint.	127
		5,0

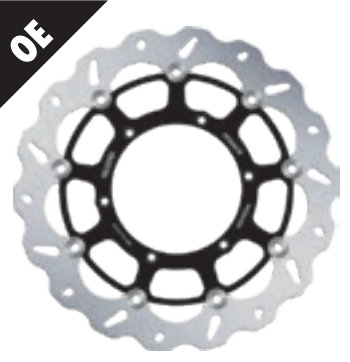

1.310 gr

* UNTIL STOCKS END

GALFER
DF
840
W

	øext.	240
	mm	
	øint.	114
		4,0



550 gr

GALFER
DF
843
CW_{I-D}

	øext.	320
	mm	
	øint.	64
		5,0



1.333 gr

GALFER
DF
847
FLW

	øext.	240
	mm	
	øint.	106
		5,0



1.320 gr

OE: Original equipment (original replacement disc) - OE: Equipo original (disco de remplazo del original)

OE discs --> W - FLW - CW - V - FLV

Special discs --> WS - WLL - RW - RH - RWS - FLS - FLX - FRS - FRH - CRW - Q - FLQ



GALFER DF 855 W **OE**



øext.	283 mm
øint.	144,5
	5,0
⌒	
⌒	

1.112 gr

GALFER DF 863 W **OE**



øext.	180 mm
øint.	58
	3,5
⌒	
⌒	

380 gr

GALFER DF 870 CW **OE**

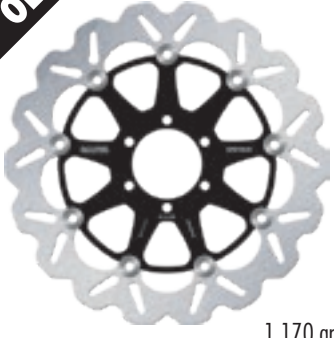

øext.	300 mm
øint.	64
	4,5
⌒	0,0
⌒	

1.170 gr

GALFER DF 860 W **OE**



øext.	300 mm
øint.	90
	4,0
⌒	
⌒	

1.012 gr

GALFER DF 863 RW **OE**

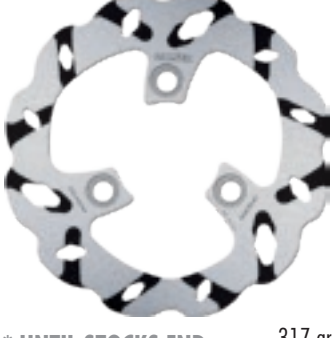

øext.	180 mm
øint.	58
	3,5
⌒	
⌒	

* UNTIL STOCKS END 317 gr

GALFER DF 872 W **OE**



øext.	200 mm
øint.	90
	3,0
⌒	
⌒	

238 gr

GALFER DF 861 W **OE**



øext.	220 mm
øint.	57
	4,0
⌒	
⌒	

657 gr

GALFER DF 864 W **OE**



øext.	226 mm
øint.	58
	4,0
⌒	
⌒	

576 gr

GALFER DF 873 W **OE**



øext.	165 mm
øint.	45
	3,0
⌒	
⌒	

220 gr

GALFER DF 862 W **OE**



øext.	260 mm
øint.	110
	3,0
⌒	
⌒	

600 gr

GALFER DF 868 W **OE**



øext.	200 mm
øint.	45
	3,0
⌒	
⌒	

393 gr

GALFER DF 874 CW **OE**



øext.	320 mm
øint.	144
	5,0
⌒	
⌒	

1.377 gr

GALFER DF 862 FLW **OE**



øext.	260 mm
øint.	110
	3,0
⌒	
⌒	

* UNTIL STOCKS END 543 gr

GALFER DF 869 W **OE**



øext.	200 mm
øint.	70
	3,6
⌒	
⌒	

411 gr

GALFER DF 875 W **OE**



øext.	256 mm
øint.	115
	5,0
⌒	
⌒	

998 gr



APPLICATIONS

PADS FD

DISCS DF

SHOES MF

LINES FK

BRACKETS SP

KITS KG

CROSS REFERENCE

GALFER
DF
876
CW

OE

	øext.	310
	mm	
	øint.	86
		4,5
		14,0



1.250 gr

GALFER
DF
880
CW

OE

	øext.	320
	mm	
	øint.	72
		4,5
		14,5

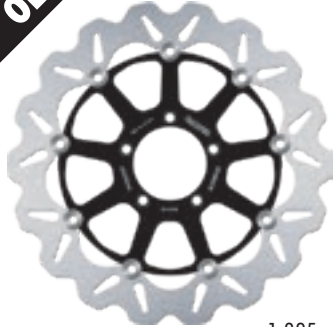

1.325 gr

GALFER
DF
885
W

OE

	øext.	220
	mm	
	øint.	112
		4,0



488 gr

GALFER
DF
876
CRW-I-D

OE

	øext.	310
	mm	
	øint.	86
		5,0
		14,0

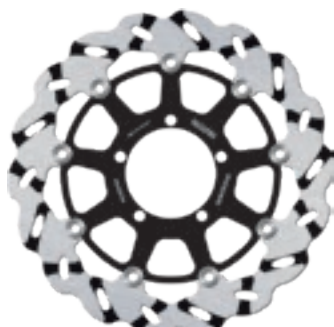

* UNTIL STOCKS END

1.200 gr

GALFER
DF
881
CW

OE

	øext.	320
	mm	
	øint.	64
		4,5
		14,5

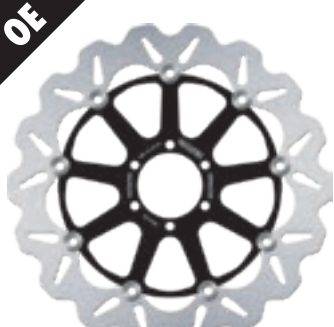

1.383 gr

GALFER
DF
885
PW

OE

	øext.	220
	mm	
	øint.	126,7
		4,0



426 gr

GALFER
DF
877
CW

OE

	øext.	310
	mm	
	øint.	78
		4,5
		16,0



1.272 gr

GALFER
DF
882
CW

OE

	øext.	340
	mm	
	øint.	60,5
		5,0
		11,0

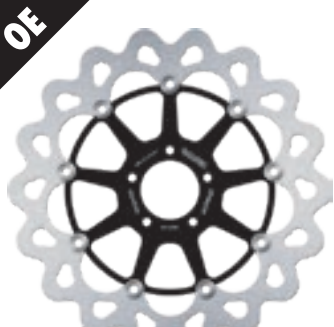

1.479 gr

GALFER
DF
887
W

OE

	øext.	220
	mm	
	øint.	110
		4,5



589 gr

GALFER
DF
878
W

OE

	øext.	180
	mm	
	øint.	58
		4,0



446 gr

GALFER
DF
883
CW

OE

	øext.	320
	mm	
	øint.	64
		4,5
		9,5

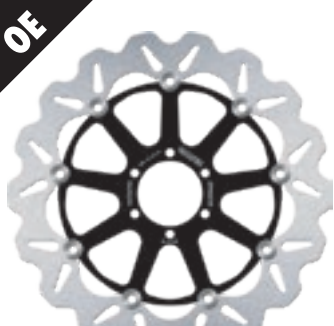

1.379 gr

GALFER
DF
888
W

OE

	øext.	280
	mm	
	øint.	108
		3,5



687 gr

GALFER
DF
879
W

OE

	øext.	220
	mm	
	øint.	88,5
		4,0



486 gr

GALFER
DF
884
W

OE

	øext.	240
	mm	
	øint.	105,5
		4,5



692 gr

GALFER
DF
889
W

OE

	øext.	220
	mm	
	øint.	62
		4,0



486 gr

OE: Original equipment (original replacement disc) - OE: Equipo original (disco de remplazo del original)

OE discs --> W - FLW - CW - V - FLV

Special discs --> WS - WLL - RW - RH - RWS - FLS - FLX - FRS - FRH - CRW - Q - FLQ



GALFER DF 892 W **OE**

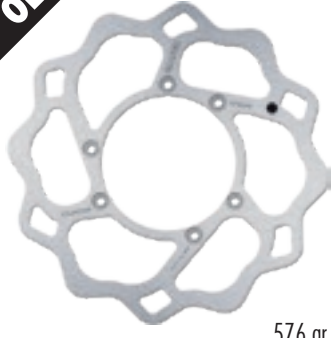

øext. 260 mm
øint. 108
4,0

576 gr

GALFER DF 899 W **OE**



øext. 196 mm
øint. 76,5
4,0

435 gr

GALFER DF 907 Q **OE**

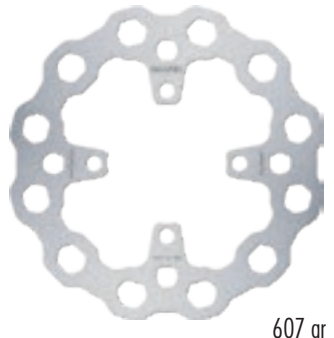

øext. 220 mm
øint. 82
5,0

607 gr

GALFER DF 894 W **OE**



øext. 170 mm
øint. 48
4,0

372 gr

GALFER DF 906 CW **OE**

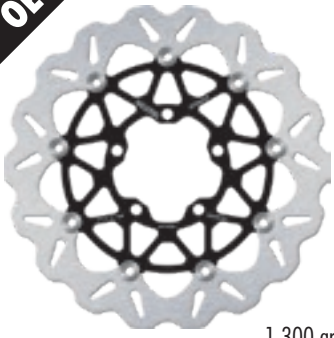

øext. 310 mm
øint. 83
5,0

1.300 gr

GALFER DF 909 CW **OE**

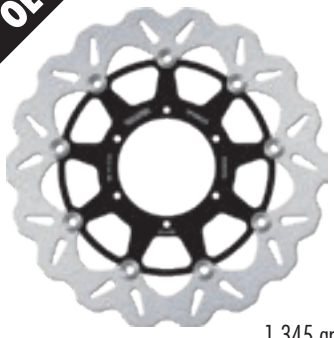

øext. 310 mm
øint. 94
5,0
21,5

1.345 gr

GALFER DF 895 W **OE**



øext. 190 mm
øint. 72
4,0

370 gr

GALFER DF 906 CRW-I-D **OE**

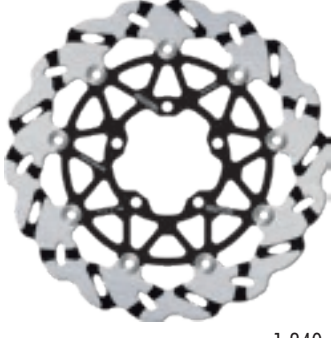

øext. 310 mm
øint. 83
5,0

* UNTIL STOCKS END 1.240 gr

GALFER DF 910 W **OE**



øext. 316 mm
øint. 184
6,0

1.341 gr

GALFER DF 897 W **OE**



øext. 240 mm
øint. 77
5,0

960 gr

GALFER DF 906 FLQ **OE**

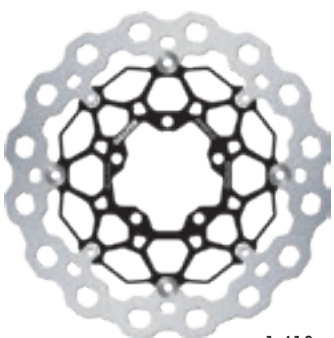

øext. 310 mm
øint. 83
5,0

1.410 gr

GALFER DF 911 W **OE**



øext. 190 mm
øint. 58
4,0

469 gr

GALFER DF 898 W **OE**



øext. 177 mm
øint. 64
4,0

353 gr

GALFER DF 907 W **OE**



øext. 220 mm
øint. 82
5,0

726 gr

GALFER DF 912 CW **OE**



øext. 330 mm
øint. 72
5,5

1.500 gr



APPLICATIONS

PADS FD

DISCS DF

SHOES MF

LINES FK

BRACKETS SP

KITS KG

CROSS REFERENCE

GALFER
DF
913
W

	øext.	245	mm
	øint.	108	
		5,0	



800 gr

GALFER
DF
918
FLW

	øext.	310	mm
	øint.	78	
		5,5	



1.750 gr

GALFER
DF
921
W

	øext.	220	mm
	øint.	112	
		4,0	



470 gr

GALFER
DF
914
FLW

	øext.	310	mm
	øint.	144	
		5,5	



1.610 gr

GALFER
DF
920
W

	øext.	260	mm
	øint.	120	
		3,0	



460 gr

GALFER
DF
921
WLL

	øext.	220	mm
	øint.	112	
		4,0	



528 gr

GALFER
DF
914
CW

	øext.	310	mm
	øint.	144	
		5,5	



* UNTIL STOCKS END

1.449 gr

GALFER
DF
920
RW

	øext.	260	mm
	øint.	120	
		3,0	



440 gr

GALFER
DF
921
RW

	øext.	220	mm
	øint.	112	
		4,0	



450 gr

GALFER
DF
915
W

	øext.	255	mm
	øint.	105	
		5,5	



1.105 gr

GALFER
DF
920
FLW

	øext.	260	mm
	øint.	120	
		3,0	



550 gr

GALFER
DF
922
W

	øext.	262	mm
	øint.	123	
		4,0	



834 gr

GALFER
DF
916
W

	øext.	285	mm
	øint.	144	
		5,0	



1.074 gr

GALFER
DF
920
FRW

	øext.	260	mm
	øint.	120	
		3,0	



590 gr

GALFER
DF
923
W

	øext.	258	mm
	øint.	105	
		4,0	



850 gr

OE: Original equipment (original replacement disc) - OE: Equipo original (disco de remplazo del original)

OE discs --> W - FLW - CW - V - FLV

Special discs --> WS - WLL - RW - RH - RWS - FLS - FLX - FRS - FRH - CRW - Q - FLQ



GALFER	OE	
DF 929 CW		
\varnothing ext. 320 mm \varnothing int. 83		
5,0		
		1.349 gr

GALFER	OE	
DF 940 CW		
\varnothing ext. 320 mm \varnothing int. 90		
5,0		
		1.297 gr

GALFER	OE	
DF 954 FLW		
\varnothing ext. 320 mm \varnothing int. 110		
5,0		
		1.575 gr

GALFER	OE	
DF 930 FLW		
\varnothing ext. 305 mm \varnothing int. 83		
5,0		
		1.550 gr

GALFER	OE	
DF 943 CW		
\varnothing ext. 320 mm \varnothing int. 136		
5,0		
		1.235 gr

GALFER	OE	
DF 955 W		
\varnothing ext. 283 mm \varnothing int. 157,5		
5,0		
		1.041 gr

GALFER	OE	
DF 931 W		
\varnothing ext. 282 mm \varnothing int. 104		
5,0		
		1.036 gr

GALFER	OE	
DF 944 W		
\varnothing ext. 260 mm \varnothing int. 110		
5,0		
		893 gr

GALFER	OE	
DF 972 W		
\varnothing ext. 247 mm \varnothing int. 131		
6,0		
		748 gr

GALFER	OE	
DF 932 W		
\varnothing ext. 300 mm \varnothing int. 124,5		
5,0		
		1.262 gr

GALFER	OE	
DF 944 FLW		
\varnothing ext. 260 mm \varnothing int. 110		
5,0		
		1.022 gr

GALFER	OE	
DF 973 W		
\varnothing ext. 245 mm \varnothing int. 100		
6,0		
		1.043 gr

GALFER	OE	
DF 933 W		
\varnothing ext. 220 mm \varnothing int. 105		
3,5		
		408 gr

GALFER	OE	
DF 952 CW		
\varnothing ext. 330 mm \varnothing int. 64		
5,0		
10,0		
		1.481 gr

GALFER	OE	
DF 980 W		
\varnothing ext. 220 mm \varnothing int. 115		
4,5		
		687 gr

APPLICATIONS
PADS **FD**
DISCS **DF**
SHOES **MF**
LINES **FK**
BRACKETS **SP**
KITS **KG**
CROSS REFERENCE



APPLICATIONS

PADS **FD**

DISCS **DF**

SHOES **MF**

LINES **FK**

BRACKETS **SP**

KITS **KG**

CROSS REFERENCE

GALFER
DF
981
W

OE

øext. 214 mm
øint. 115
4,5



523 gr

GALFER
DF
982
W

OE

øext. 248 mm
øint. 120
6,7



1.134 gr

GALFER
DF
986
W

OE

øext. 255 mm
øint. 129
5,5



1.026 gr

GALFER
DF
987
W

OE

øext. 245 mm
øint. 129
5,5



868 gr

BRAKE SHOES
MORDAZAS DE FRENO

GANASCE FRENO
MÂCHOIRES DE FREIN

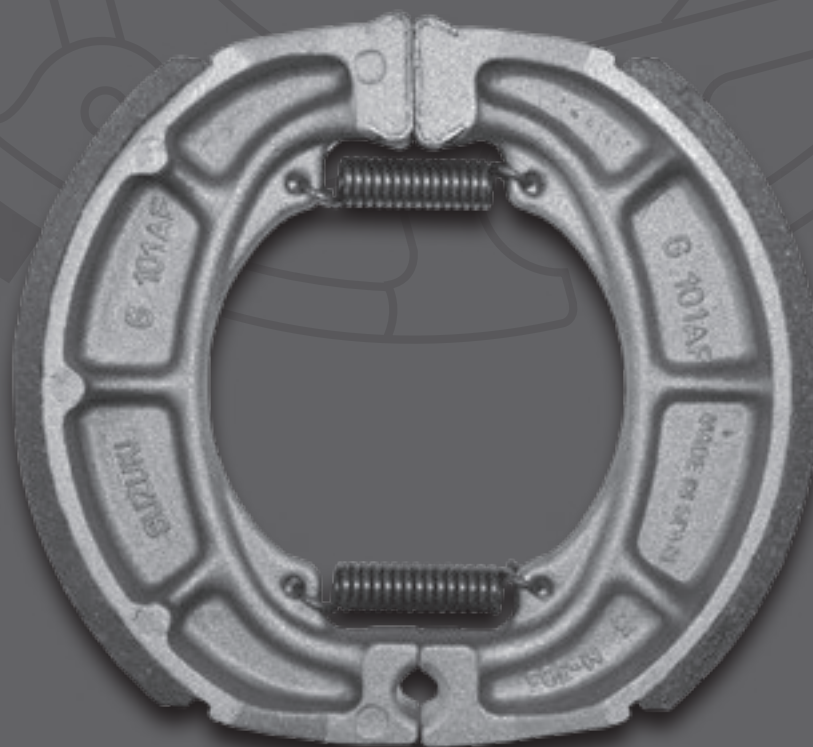



APPLICATIONS

PADS FD

DISCS DF

SHOES MF

LINES FK

BRACKETS SP

KITS KG

CROSS REFERENCE

GALFER
MF
001
G2165

↔ 95
mm x
↔ 20

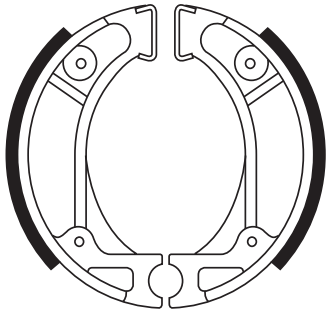

GALFER
MF
002
G2165

↔ 110
mm x
↔ 25

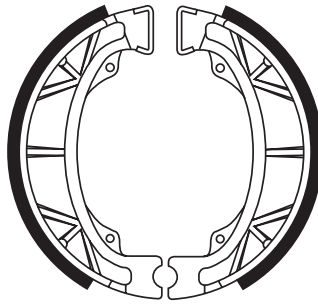

GALFER
MF
003
G2165

↔ 110
mm x
↔ 25

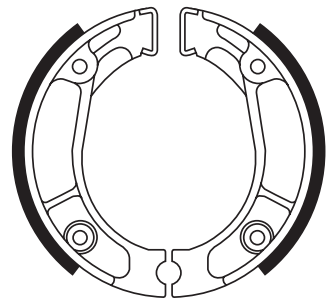

GALFER
MF
004
G2165

↔ 80
mm x
↔ 18

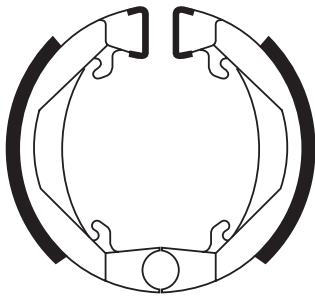

GALFER
MF
005
G2165

↔ 130
mm x
↔ 30

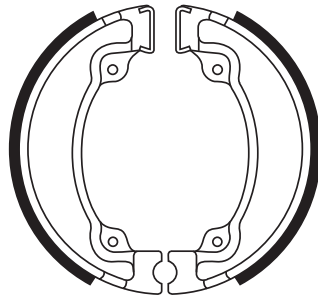

GALFER
MF
006
G2165

↔ 130
mm x
↔ 30

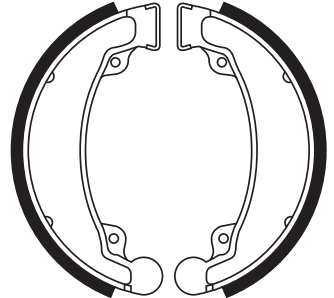

GALFER
MF
007
G2165

↔ 95
mm x
↔ 20

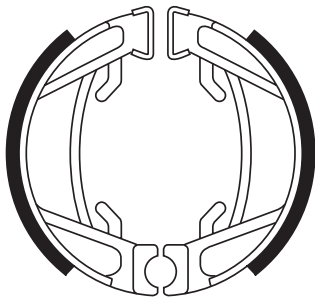

GALFER
MF
008
G2165

↔ 110
mm x
↔ 25

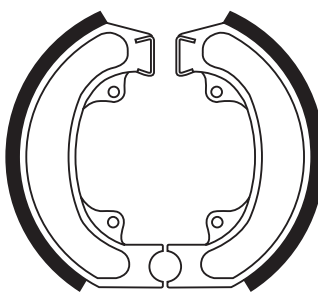

GALFER
MF
010
G2165

↔ 80
mm x
↔ 18

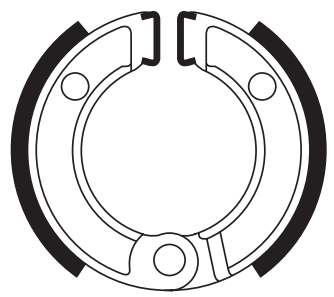

GALFER
MF
044
G2165

↔ 160
mm x
↔ 30

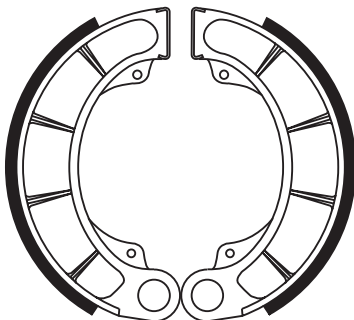

GALFER
MF
051
G2165

↔ 125
mm x
↔ 25

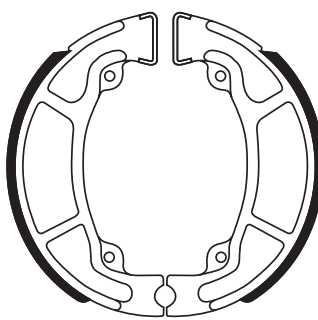

GALFER
MF
151
G2165

↔ 130
mm x
↔ 28

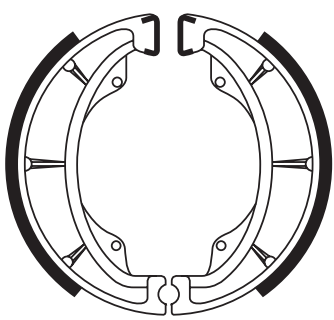

GALFER
MF
160
G2165

↔ 180
mm x
↔ 35

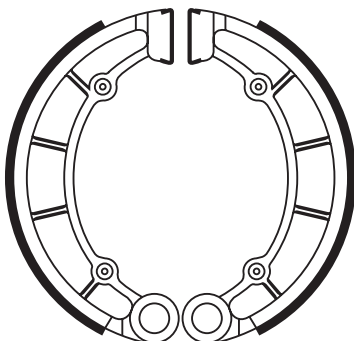

GALFER
MF
301
G2165

↔ 120
mm x
↔ 35

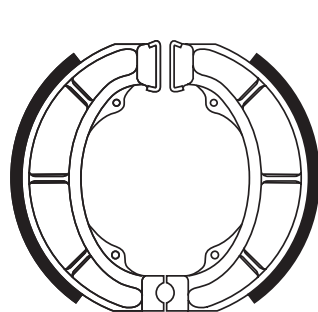

GALFER
MF
302
G2165

↔ 80
mm x
↔ 17

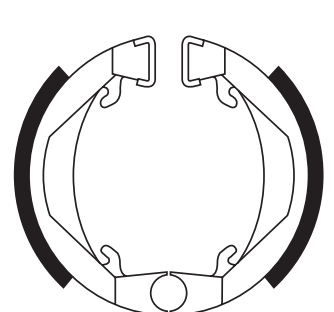



GALFER
MF
451
G2165

↔ 130
mm x
↔ 28

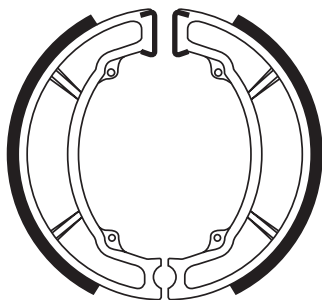

GALFER
MF
452
G2165

↔ 150
mm x
↔ 25

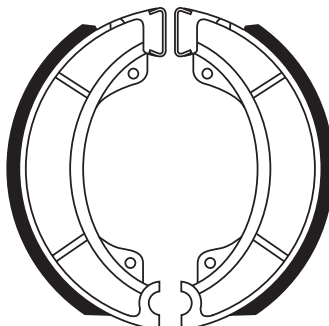

GALFER
MF
453
G2165

↔ 110
mm x
↔ 25

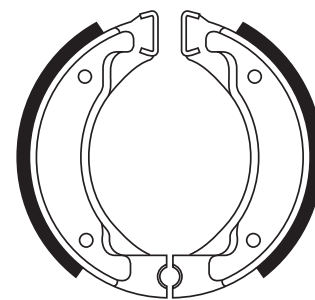

GALFER
MF
454
G2165

↔ 80
mm x
↔ 17

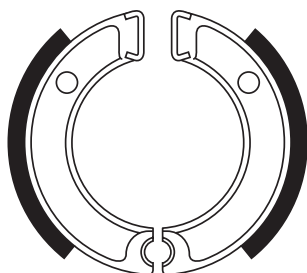

GALFER
MF
455
G2165

↔ 100
mm x
↔ 20

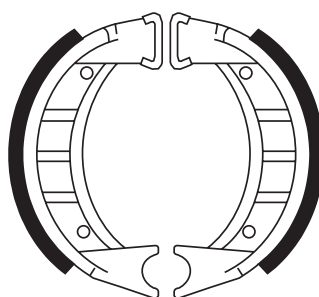

GALFER
MF
456
G2165

↔ 150
mm x
↔ 25

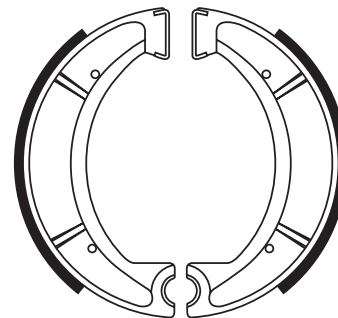

GALFER
MF
458
G2165

↔ 110
mm x
↔ 25

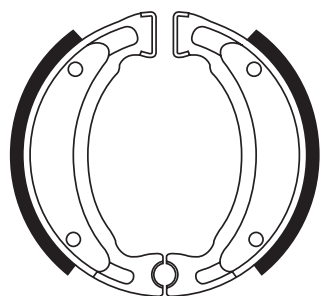

GALFER
MF
459
G2165

↔ 200
mm x
↔ 40

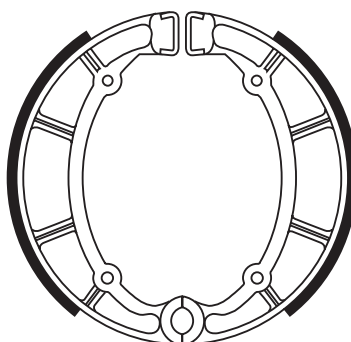

GALFER
MF
478
G2165

↔ 150
mm x
↔ 28

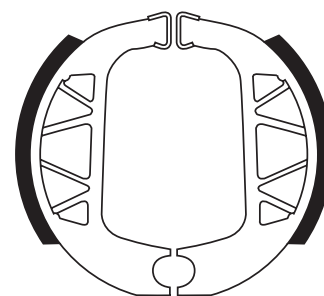

GALFER
MF
601
G2165

↔ 150
mm x
↔ 24

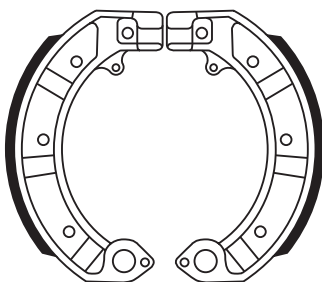

GALFER
MF
602
G2165

↔ 125
mm x
↔ 17

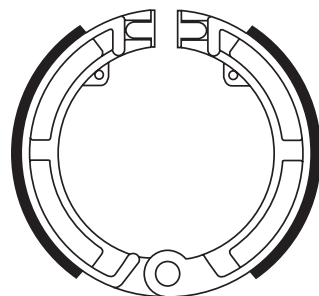

GALFER
MF
605
G2165

↔ 170
mm x
↔ 25

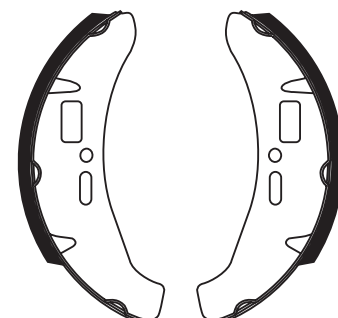

GALFER
MF
606
G2165

↔ 95
mm x
↔ 20

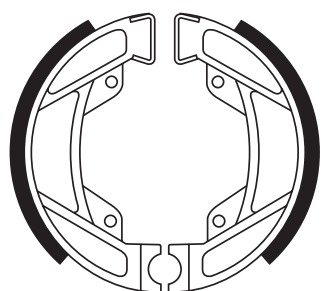

GALFER
MF
608
G2165

↔ 110
mm x
↔ 30

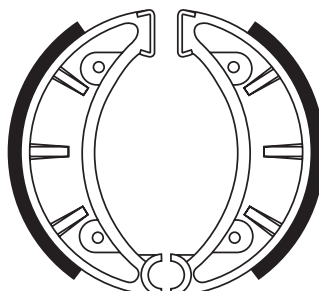

GALFER
MF
610
G2165

↔ 200
mm x
↔ 25

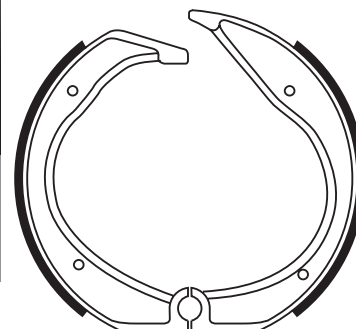



APPLICATIONS

PADS **FD**

DISCS **DF**

SHOES **MF**

LINES **FK**

BRACKETS **SP**

KITS **KG**

CROSS REFERENCE

GALFER
MF
615
G2165

↔ 105
mm x
↔ 20

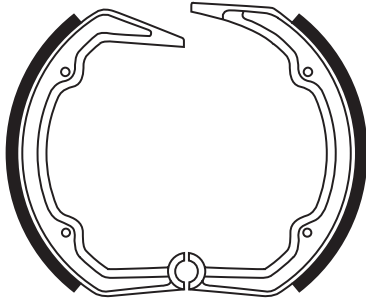

GALFER
MF
617
G2165

↔ 105
mm x
↔ 20

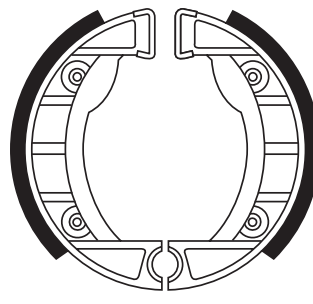

GALFER
MF
618
G2165

↔ 90
mm x
↔ 18

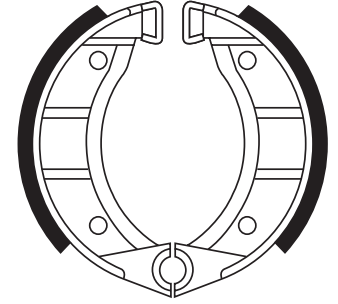

GALFER
MF
619
G2165

↔ 150
mm x
↔ 24

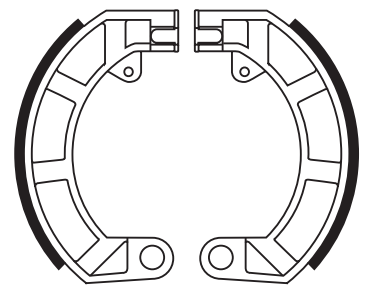

GALFER
MF
620
G2165

↔ 110
mm x
↔ 25

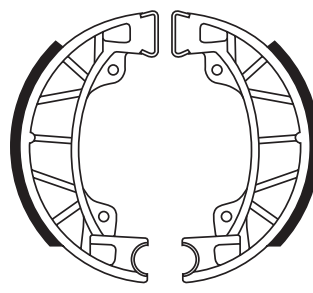

GALFER
MF
621
G2165

↔ 100
mm x
↔ 20

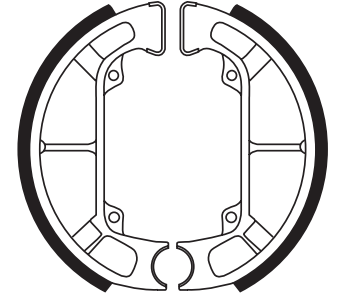

GALFER
MF
622
G2165

↔ 130
mm x
↔ 20

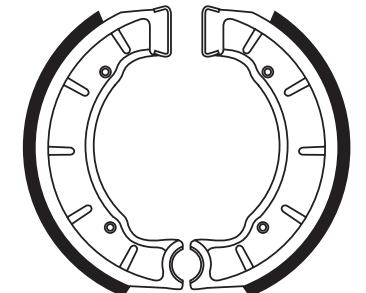

GALFER
MF
625
G2165

↔ 105
mm x
↔ 25

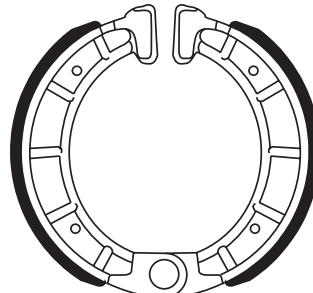

GALFER
MF
626
G2165

↔ 110
mm x
↔ 25

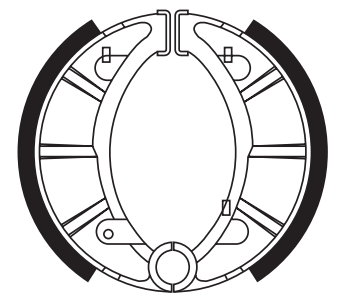

GALFER
MF
627
G2165

↔ 80
mm x
↔ 20

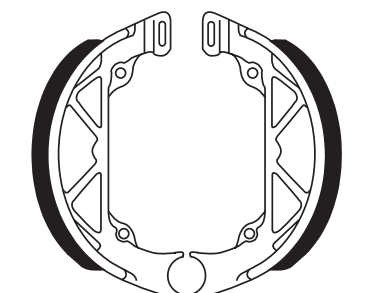

GALFER
MF
630
G2165

↔ 110
mm x
↔ 25

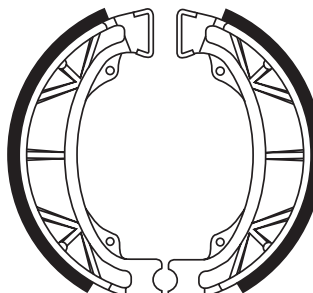

GALFER
MF
631
G2165

↔ 104
mm x
↔ 20

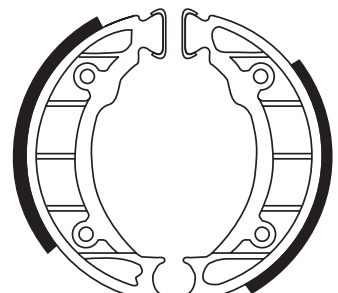

GALFER
MF
636
G2165

↔ 110
mm x
↔ 25

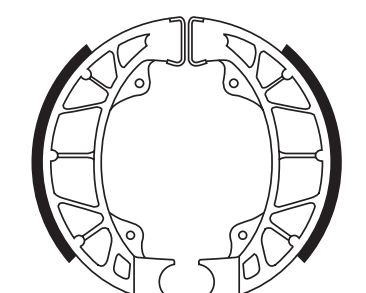

GALFER
MF
637
G2165

↔ 110
mm x
↔ 22

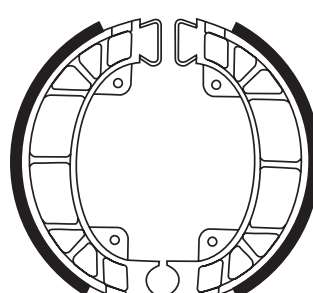

GALFER
MF
639
G2165

↔ 125
mm x
↔ 25

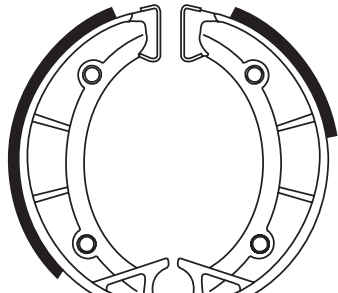



GALFER
MF
640
G2165

↔ 130
mm x
↔ 28

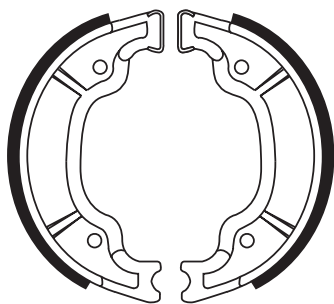

GALFER
MF
650
G2165

↔ 130
mm x
↔ 25

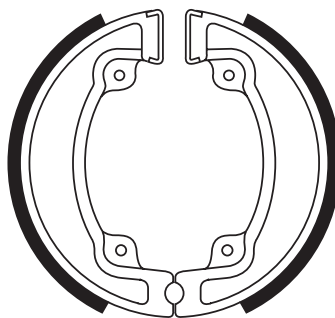

GALFER
MF
712
G2165

↔ 125
mm x
↔ 25

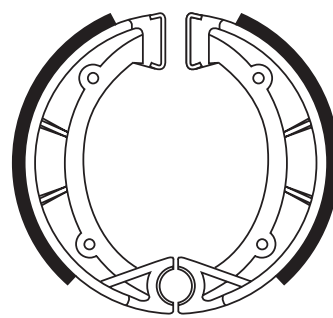

GALFER
MF
717
G2165

↔ 100
mm x
↔ 20

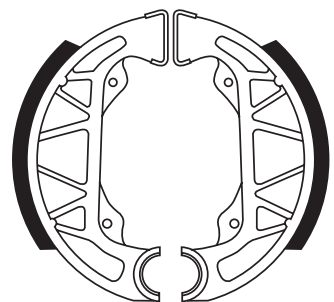

GALFER
MF
732
G2165

↔ 110
mm x
↔ 25

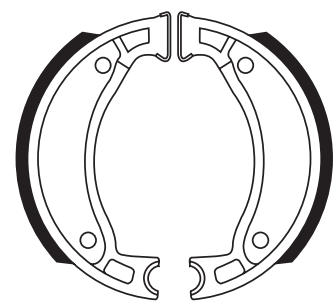

GALFER
MF
740
G2165

↔ 130
mm x
↔ 25

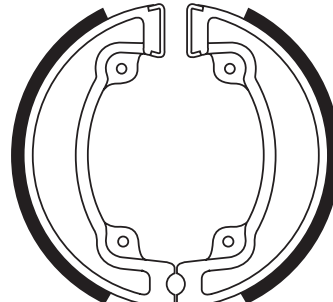

GALFER
MF
750
G2165

↔ 90
mm x
↔ 18

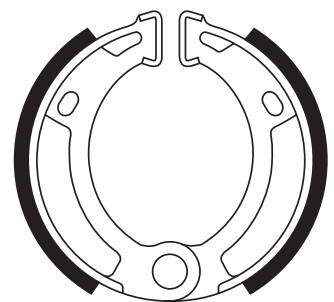

GALFER
MF
765
G2165

↔ 152
mm x
↔ 25

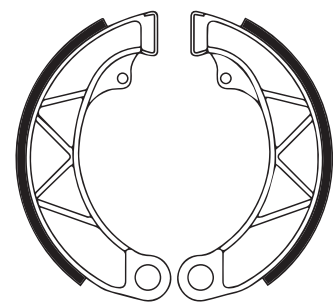

GALFER
MF
766
G2165

↔ 152
mm x
↔ 25

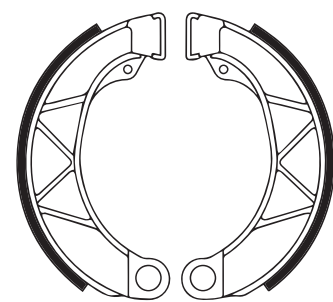

APPLICATIONS

PADS FD

DISCS DF

SHOES MF

LINES FK

BRACKETS SP

KITS KG

CROSS REFERENCE

GALFER

PASSION NEVER STOPS



- Randy Krummenacher -
2019 Supersport World Champion

LINES & ACCESSORIES
LATIGUILLOS Y ACCESORIOS

TUBI FRENO E ACCESSORI

DURITES ET ACCESSOIRES





APPLICATIONS

PADS FD

DISCS DF

SHOES MF

LINEAS FK

BRACKETS SP

KITS KG

CROSS REFERENCE

AVAILABLE FINISHES · ACABADOS DISPONIBLES FINITURE DISPONIBILI · FINIS DISPONIBLES			
Ref.	Tube · Tubo · Tubo · Tube	Banjos · Banjos · Banjo · Banjos	
FK003	Transparent · Transparente Trasparente · Transparent	Silver brass · Latón plata Ottone silver · Laiton argenté	
FK103	Black · Negro · Nero · Noir		
FK303	Red · Rojo · Rosso · Rouge		
FK403	Carbon · Carbono · Carbone · Carbone		

BRAND & MODEL MARCA Y MODELO	C.C.	YEAR	FRONT	REAR	CLUTCH
ZX 10R	1000	04 05	C415	C415R	
ZX 10R	1000	06 07	C495	C495R	
ZX 10R	1000	08 15	C646	C646R	
ZX 10R	1000	11	CE043	CE043R	
ZX 10R	1000	16	C886	C886R	
ZX 10R ABS	1000	11	C785		
ZX 1000 RX NINJA	1000	88	C124		
GPZ 1100 (ZX1100E1) LEFT/IZQ	1100	95	C114		
GPZ 1100 (ZX1100E1) RIGHT/DER	1100	95	C114	C114R	
GPZ 1100 S	1100	95	C144		C144E
ZEPHYR 1100	1100	93 95	C103	C103R	C103E
ZRX 1100	1100	97 00	C242	C242R	C242E
ZX 1100	1100	93	C010	C010R	C010E
ZZR 1200	1200	01	C326	C326R	C326E
ZRX 1200 S	1200	02 03	C242	C242R	C242E
ZRX 1200 S	1200	04	C242	C242R	C242E
ZX-12 R	1200	00 03	C260	C260R	
ZX-12 R	1200	04	C416	C416R	
GTR 1400	1400	07 09	C626	C626R	
ZG 1400 CONCOURS	1400	08	C626	C626R	C625E
ZG 1400 CONCOURS ABS	1400	08 09	C625	C625R	C625E
ZG 1400 CONCOURS ABS	1400	10	C768	C625R	C625E
ZX-14 R	1400	06 14	C484	C484R	C484E
ZX-14 R	1400	15	C484	C484R	C909L
ZX-14 R ABS	1400	14	C799C		
VN 1500 MEAN STREAK	1500	01	C302	C302R	C302E
VN-CLASSIC	1500	96 97	C026	C099R	
VN-EASSIC Fi	1500	00	C670	C670R	C670E
VN-CLASSIC TOURER LEFT/IZQ	1500	98 99	C367		
VN-EASSIC TOURER RIGHT/DER	1500	98 99	C367	C367R	C367E
VN 1600 MEAN STREAK	1600	04 04	C440	C302R	C302E
VN 1600 MEAN STREAK	1600	05	C487		
VN 1600 SUMO/EASSIC RIGHT/DER	1600	03	C411		C411E
VN 1600 NOMAD LEFT/IZQ	1600	05	C487		
VN 1600 NOMAD RIGHT/DER	1600	05	C487	C487R	
VN 1700 CLASSIC LEFT/IZQ	1700	09	C708		
VN 1700 CLASSIC RIGHT/DER	1700	09	C708	C708R	C708E
VN 1700 VOYAGER CUSTOM ABS	1700	11	C802C	INCL	
VN 2000	2000	04	CE028		
KAWASAKI 4 Wheels					
KSF 250 A1-> A7 MOJAVE	250	87 93	C394	C394R	
KXF 250 A1,A2 TECATE	250	87 88	C368		
KFX 400	400	03	C308	C308R	
KFX 450 R RIGHT/DER.	450	07	C589	C589R	
KFX 700 IZQ.	700	03	C364	-	
KFX 700 TEAM GREEN IZQ.	700	05	C364	-	
KTM					
65 SX	65	04 08	C763	C763R	
65 SX	65	09	C763	C763R	
65 XC	65	08	C763	C763R	
85 SX	85	11 11	C762	C762R	
85 SX 17/14	85	12	C762	C762R	
85 SX 19/16	85	13	C762	C762R	
125 DUKE	125	11	CE039	CE039R	
125 DUKE ABS	125	14	CE044C	INCL	
125 SX	125	04 14	C427	C428R	
125 SX	125	15	C761	C761R	
150 SX	150	15	C761	C761R	
150 XC	150	15	C742	C742R	
200 DUKE	200	12	CE039	CE039R	
200 DUKE ABS	200	14	CE044C	INCL	
200 XC-W	200	15	C742	C742R	
250 SX	250	03 14	C427	C428R	

REFERENCES DESCRIPTION · DESCRIPCIÓN REFERENCIAS DESCRIZIONE REFERENZA · DESCRIPTION RÉFÉRENCE	
C__R	rear · trasero · posteriore · arrière
C__3	3 lines · 3 tubos · 3 tubi · 3 durit
C__E	clutch · embrague · frizione · embrayage
C__G	GP · GP · GP · GP
C__C	F&R full · completo F&R · completo F&R · completo F&R
INCL	included · incluido · incluso · inclus

BRAND & MODEL MARCA Y MODELO	C.C.	YEAR	FRONT	REAR	CLUTCH
250 SX-F / FACTORY	250	15	C761	C761R	
250 XC-W / XCF-W	250	15	C742	C742R	
250 XC-F	250	15	C742	C761R	
300 EXC	300	03 03	C317	C317R	C317E
300 EXC	300	04	C428	C428R	
300 EXC-E	300	08	C742	C742R	
300 XC / W / SIX DAYS	300	06	C742	C742R	
350 EXC-F	350	15	C742	C742R	
350 SX F	350	11	C761	C761R	
350 XC-F	350	15	C761	C742R	
350 XCF-W / SIX DAYS	350	15	C742	C742R	
390 DUKE	390	13	CE039	CE039R	
390 DUKE ABS	390	14	CE044C	INCL	
RC 390	390	15	C871	C871R	
400 EXC	400	04	C317	C317R	C317E
450 EXC	450	04	C428	C428R	
450 EXC - R	450	08	C742	C742R	
450 SXF / FACTORY	450	07	C761	C761R	
450 XC-F	450	15	C761	C742R	
450 XCF-W	450	15	C742	C742R	
500 EXC / SIX DAYS / XC-W	500	15	C742	C742R	
525 EXC	525	03 03	C317	C317R	C317E
525 EXC	525	04	C428	C428R	
530 EXC - R	530	08	C742	C742R	
560 SMR	560	07	C617		
640 LC4 ADVENTURE R	640	99 05	C428	C450R	C450E
690 DUKE	690	12	CE040	CE040R	
690 SMC R ABS	690	13	CE045C	INCL	
990 ADVENTURE R	990	09	C721		
KTM 4 Wheels					
450 XC	450	08	C637		
525 XC	525	08	C637	C637R	
KYMCO 4 Wheels					
KXR 250 SPORT	250	04	C18AD	C18AT	
MXU 250	250	05	C18AD	C18AT	
MXU 300	300	05	C18AD	C18AT	
PEUGEOT					
ELYSEO	50	98	C901	-	
SPEEDFIGHT LC	50	97	CE004	CE004R	
ELYSEO 100	100	98	C901	-	
PIAGGIO					
VESPA 50 ET2	50	00	CE019	-	
VESPA 50 ET4	50	01	CE019	-	
ZIP FAST-RIDER	50	93 95	C16AD	-	
ZIP SP LC	50	96 99	CE003	-	
ZIP CATALIZADA	50	00	CE003	-	
ZIP 4T	50	00	CE003	-	
POLARIS 4 Wheels					
OUTLAW 450 S	450	08	C683		
OUTLAW 525 IRS	525	08	C624	C624R	
RANGER 900 RZR XP	900	12	C779		
SUZUKI					
RM 80	80	96 02	C234	C234R	
RM 85 / L	85	03 04	C331	C331R	
RM 85 / L	85	05	C479	C479R	
DR-Z 125 L	125	03	C345	-	
RM 125	125	89 95	C073	C073R	
RM 125	125	96 98	C126	C126R	
RM 125	125	99 03	C126	C126R	
RM 125	125	04 05	C429	C429R	
RM 125	125	06	C429	C429R	
DR 200	200	86 88	C158	-	
DR 200 K	200	89	C158	-	



APPLICATIONS

PADS FD

DISCS DF

SHOES MF

LINEAS FK

BRACKETS SP

KITS KG

CROSS REFERENCE

AVAILABLE FINISHES · ACABADOS DISPONIBLES FINITURE DISPONIBILI · FINIS DISPONIBLES			
Ref.	Tube · Tubo · Tubo · Tube	Banjos · Banjos · Banjo · Banjos	
FK003	Transparent · Transparente Trasparente · Transparent	Silver brass · Latón plata Ottone silver · Laiton argenté	
FK103	Black · Negro · Nero · Noir		
FK303	Red · Rojo · Rosso · Rouge		
FK403	Carbon · Carbono · Carbone · Carbone		

BRAND & MODEL MARCA Y MODELO	C.C.	YEAR	FRONT	REAR	CLUTCH
VS 1400 (S83 USA)	1400	04	C492	C492R	C492E
VL 1500 INTRUDER LEGENDARY EASSIC	1500	98 99	C270	C270R	C270E
VL 1500 INTRUDER LEGENDARY CLASSIC	1500	00 01	C270	C270R	C270E
VL 1500 INTRUDER LEFT /IZQ	1500	02	C441		
VL 1500 INTRUDER RIGHT/DER	1500	02	C441	C441R	
VZ 1600	1600	04	C436	C436R	C436E
M 109 R BOULEVARD	1800	06 13	C514	C514R	
M 109 R BOULEVARD	1800	14	C798	C514R	
M 1800 RB	1800	14	C798	C514R	
SUZUKI 4 Wheels					
LT 250 F OZARK	250	02	C358	-	
LT 250 RF/RG/RH	250	85 87	C076	C076R	
LT 250 RJ/RK/RL/RM/RN	250	88 92	C076	C076R	
LT Z-250 K4 QUAD SPORT	250	04	C358	-	
LT Z 400	400	03	C308	C308R	
LT R 450 RIGHT/DER.	450	06	C498	C498R	
LT 500 RH,RJ,RK,RL,RM,RN	500	91 93	C387		
SYM					
SYMPHONY 125	125	09	CE027	-	
SYMPHONY 125 S	125	10	CE027		
SYMPHONY 125 SR	125	10	CE027		
TM					
MX 80	80	14	CE060	CE060R	CE060E
MX 85	85	14	CE060	CE060R	CE060E
MX 100	100	14	CE060	CE060R	CE060E
TRIUMPH					
TT 600	600	00	C226	C226R	
DAYTONA TRIPLE	675	06 08	C675	C675R	
BONNEVILLE AMERICA	750	02	C329		
BONNEVILLE /T100	800	04 05	C329	C329R	
BONNEVILLE /T100	850	05 07	C329	C329R	
BONNEVILLE EFI /T100	800	08	C329	C329R	
DAYTONA 900	900	93 96	C207	C207R	
DAYTONA 900 T-595	900	97	C207	C207R	
LEGEND TT	900	99	C351	C351R	
THUNDERBIRD 900/SPORT	900	95	C179	C179R	
TIGER 900 (left)	900	93 98	C149		
TIGER 900 (right)	900	93 98	C149		C149E
TRIDENT 900 (left)	900	93	C268		
TRIDENT 900 (right)	900	93	C268	C268R	C268E
SPEED TRIPLE 955 i	955	99 01	C321	C321R	
SPRINT RS	955	00	C307		
SPRINT ST 955	955	99	C307		
SPEED TRIPLE T-509	995	99	C389		
TIGER 955	955	99	C350	C350R	
SPRINT ST 1050	1050	06	C676	C676R	
TROPHY 1200	1200	94	C143	C143R	C143E
ROCKET III	2300	04	C671	C671R	
ROCKET III ROADSTER	2300	10	C671	C671R	
VICTORY					
HAMMER / S	1500	01 07	C547	C546R	
KING PIN	1500	08	C546	C546R	
VEGAS	1500	03 07	C546	C546R	
ALL MODELS	1500	15	C885		
YAMAHA					
AEROX 50	50	97	CE001	CE001R	
AEROX 50 NAKED	50	13	CE001	CE001R	
BW'S SPY 50	50	95 95	CE006	-	
BW'S 50 R	50	95 95	CE006	-	
BW'S BUMP	50	96	CE006	-	
BW'S NEXT GENERATION 50	50	96	CE006	-	
BW'S NAKED	50	06	CE006	-	
BW'S WHEEL12"	50	06	CE006	-	

REFERENCES DESCRIPTION · DESCRIPCIÓN REFERENCIAS DESCRIZIONE REFERENZA · DESCRIPTION RÉFÉRENCE	
C___R	rear · trasero · posteriore · arrière
C___3	3 lines · 3 tubos · 3 tubi · 3 durit
C___E	clutch · embrague · frizione · embrayage
C___G	GP · GP · GP · GP
C___C	F&R full · completo F&R · completo F&R · completo F&R
INCL	included · incluido · incluso · inclus

BRAND & MODEL MARCA Y MODELO	C.C.	YEAR	FRONT	REAR	CLUTCH
TZR 50 RR	50	03	CE035		
YSR 50, T	50	86	C084	-	
YZ 80	80	93 02	C276	C276R	
YZ 85 / LW	85	03	C347	C347R	
N MAX 125	125	16	CE065	-	
TT R 125	125	00	C325	-	
X - MAX 125	125	06 09	CE033	CE033R	
YZ 125	125	85 87	C402	-	
YZ 125	125	88 88	C402		
YZ 125	125	08	C344	C413R	
YZ 125, WR	125	90 91	C083	C083R	
YZ 125, WR	125	92 97	C120	C120R	
YZ 125, WR	125	98 00	C344	C344R	
YZ 125, WR	125	01 02	C344	C344R	
YZ 125, WR	125	03 03	C344	C346R	
YZ 125, WR	125	04	C344	C413R	
YZF 125 R	125	08 13	CE012	CE012R	
YZF 125 R	125	14	CE064	CE064R	
CRYPTON-X T 135	135	08 14	CE055	-	
N MAX 150	150	17	CE065	-	
DT 200 R	200	88	C328	-	
TW 200	200	98	C731	-	
TT 225 R	225	00	C272	-	
XT 225	225	92 00	C614	-	
XT 225	225	01	C737	-	
TT-R 230	230	15	C467		
WR 250 F 4T	250	03 06	C198	C413R	
WR 250 F 4T	250	07	C198	C413R	
WR 250 X	250	08	C697	C413R	
X - MAX 250	250	05 09	CE033	CE032R	
XT 250 X	250	06	C648	C648R	
XVS 250 DRAG STAR	250	01	C706	-	
WR 250 F	250	16	CE070		
YZ 250	250	08	C344	C413R	
YZ 250, W, RALLY	250	90 91	C083	C083R	
YZ 250, WR	250	92 98	C120		
YZ 250, WR	250	99 00	C344	C182R	
YZ 250 F, WR F 4T	250	00 00	C344	C182R	
YZ 250, WR	250	01 02	C344	C182R	
YZ 250 F, WR F 4T	250	01 02	C344	C182R	
YZ 250 F	250	03 06	C344	C346R	
YZ 250 F, WR F 4T	250	03 06	C344	C346R	
YZ 250 F	250	07 08	C627	C627R	
YZ 250 F	250	09 15	CE010	CE010R	
YZ 250 F	250	16	CE058	C622R	
YZ 250 FX	250	15	C622	C622R	
YZ 250 X	250	15	C344	C413R	
YZF - R3	320	15	C810	CE063R	
RD 350 LC, F	350	85 90	C193	C193R	
FZR 400 RR	400	90	C081	C081R	
RD 400 S	400	73 76	C211	-	
WR 400 F	400	98 98	C344	C198R	
WR 400 F	400	99 99	C344	C198R	
YZ 400 F	400	98 98	C344	C198R	
YZ 400 F	400	99 99	C344	C198R	
WR 426 F	425	00 01	C344	C198R	
WR 426 F	425	02 02	C344	C198R	
YZ 426 F	425	00 01	C344	C198R	
YZ 426 F	425	02 02	C344	C198R	
WR 450 F	450	03 11	C198	C413R	
WR 450 F	450	16	CE070		
YZ 450 F	450	03 07	C344	C344R	
YZ 450 F	450	08 11	C622	C622R	



APPLICATIONS

PADS **FD**

DISCS **DF**

SHOES **MF**

LINES **FK**

BRACKETS **SP**

KITS **KG**

CROSS REFERENCE

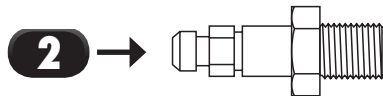

3 → BLEED NIPPLES · TORNILLO SANGRADOR
VITE DI SPURGO · VIS DE PURGE



THREAD · PASO ROSCA FILETTO · FILL	SILVER BRASS · LATÓN PLATA OTTONE ARGENTO · LAITON ARGENT
10 mm	FK003D0130
12 mm	FK013D0131

DESCRIPTION · DESCRIPCIÓN · DESCRIZIONE · DESCRIPTION

1 Reference base of the piece
Referencia base de la pieza
Riferimento base del pezzo
Référence base de la pièce

2 Piece drawing 1:1 scale
Dibujo pieza a escala 1:1
Illustrazione pezzo scala 1:1
Schéma pièce echelle 1:1

3 Piece description
Descripción de la pieza
Descrizione del pezzo
Description de la pièce

4 Options and complete reference of the piece
Opciones y referencia completa de la pieza
Opzioni e riferimento completa del pezzo
Options et référence complète de la pièce



REF.	COLOUR
*D0011	Black Negro Nero Nair
*D0012	Transparent Transparente Transparente Transparent
*K0020	Red Rojo Rosso Rouge
*D0031	Carbon Carbono Carbonio Carbon

REF.	SIZE
FK015*	15 cm
FK025*	25 cm
FK030*	30 cm
FK035*	35 cm
FK040*	40 cm
FK045*	45 cm
FK050*	50 cm
FK055*	55 cm
FK060*	60 cm
FK065*	65 cm
FK070*	70 cm
FK075*	75 cm
FK080*	80 cm
FK085*	85 cm
FK090*	90 cm
FK095*	95 cm
FK100*	100 cm
FK105*	105 cm
FK110*	110 cm
FK120*	120 cm
FK130*	130 cm
FK140*	140 cm
FK150*	150 cm



HOSES · TUBERÍA
TUBI FRENO · DURITES

GALFER
FK

APPLICATIONS

PADS FD

DISCS DF

SHOES MF

LINES FK

BRACKETS SP

KITS KG

CROSS REFERENCE

THREAD · PASO ROSCA FILETTO · FILL	SILVER BRASS · LATÓN PLATA OTTONE ARGENTO · LAITON ARGENT
M. 10 x 1.00	FK003D051A
M. 10 x 1.25	FK003D051B
3/8 (24h UNEF)	FK003D051C
1/8 (28h GAS)	FK003D051D

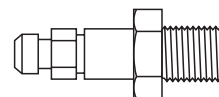

BLEED NIPPLES · TORNILLO SANGRADOR
VITE DI SPURGO · VIS DE PURGE

GALFER
FK
051

THREAD · PASO ROSCA FILETTO · FILL	SILVER BRASS · LATÓN PLATA OTTONE ARGENTO · LAITON ARGENT
M. 10 x 1.00	FK003D008A
M. 10 x 1.25	FK003D008B
1/8 (28h GAS)	FK003D008D

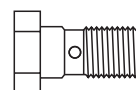

BANJO BOLT · TORNILLO BANJO
BULLONE SEMPLICE RACCORDO · VIS BANJO

GALFER
FK
008

THREAD · PASO ROSCA FILETTO · FILL	SILVER BRASS · LATÓN PLATA OTTONE ARGENTO · LAITON ARGENT
M. 10 x 1.00	FK003D009A
M. 10 x 1.25	FK003D009B
3/8 (24h UNF)	FK003D009C
1/8 (28h GAS)	FK003D009D
7/16 (24h)	FK013D009F

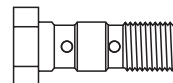

DOUBLE BANJO BOLT · TORNILLO BANJO DOBLE
BULLONE DOPPIO RACCORDO · VIS BANJO DOUBLE

GALFER
FK
009

THREAD · PASO ROSCA FILETTO · FILL	SILVER BRASS · LATÓN PLATA OTTONE ARGENTO · LAITON ARGENT
A. 1/8 (28h GAS) - B. M. 10 x 1.00	FK003D007A
A. 1/8 (28h GAS) - B. M. 10 x 1.25	FK003D007B
A. 1/8 (28h GAS) - B. 3/8 (24h UNE)	FK003D007C

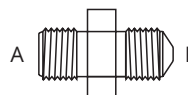

CONCAVE ADAPTER · ADAPTADOR CÓNCAVO
ADATTATORE CONCAVO · ADAPTEUR CONCAVE

GALFER
FK
007



APPLICATIONS

GALFER
FK
007

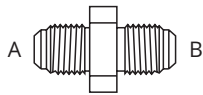

CONVEX ADAPTER • ADAPTADOR CONVEXO
ADATTATORE CONVESSO • ADAPTATEUR CONVEXE

THREAD • PASO ROSCA FILETTO • FILL	SILVER BRASS • LATÓN PLATA OTTONE ARGENTO • LAITON ARGENT
A. M.10 x 1.00 - B. M.10 x 1.25	FK003D007E
A. M.10 x 1.00 - B. 3/8 (24h UNE)	FK003D007F
A. 3/8 (24h UNE) - B. 3/8 (24h UNE)	FK003D007G

PADS FD

GALFER
FK
024

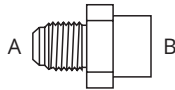

ADAPTER • ADAPTADOR
ADATTATORE • ADAPTATEUR

THREAD • PASO ROSCA FILETTO • FILL	SILVER BRASS • LATÓN PLATA OTTONE ARGENTO • LAITON ARGENT
A. M.10 x 1.00 - B. M.10 x 1.25	FK003D024B
A. M.10 x 1.00 - B. 3/8 (24h UNF)	FK003D024C
A. M.10 x 1.25 - B. M.10 x 1.00	FK003D024D
A/B M.10 x 1.25	FK003D024E
A. M.10 x 1.25 - B. 3/8 (24h UNF)	FK003D024F
A. 3/8 (24h UNF) - B. M.10 x 1.25	FK003D024H
A/B 3/8 (24h UNF)	FK003D024i

DISCS DF

GALFER
FK
030

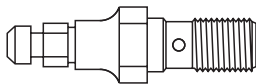

BLEED BANJO • BANJO SANGRADOR
RACCORDO DI SPURGO • BANJO DE GRAISSAGE

THREAD • PASO ROSCA FILETTO • FILL	SILVER BRASS • LATÓN PLATA OTTONE ARGENTO • LAITON ARGENT
M.10 x 1.00	FK003D030A
M.10 x 1.25	FK003D030B
3/8 (24h UNF)	FK003D030C
1/8 (28h GAS)	FK003D030D
A. 3/8 (24h UNF) - B. M.10 x 1.25	FK003D024H
A/B 3/8 (24h UNF)	FK003D024i

SHOES MF

LINEAS FK

GALFER
FK
031

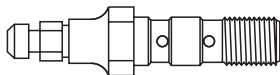

DOUBLE BLEED BANJO • BANJO SANGRADOR DOBLE
RACCORDO DI SPURGO DOPPIO • BANJO DOUBLE DE GRAISSAGE

THREAD • PASO ROSCA FILETTO • FILL	SILVER BRASS • LATÓN PLATA OTTONE ARGENTO • LAITON ARGENT
M.10 x 1.00	FK003D031A
M.10 x 1.25	FK003D031B
3/8 (24h UNF)	FK003D031C
1/8 (28h GAS)	FK003D031D

BRACKETS SP

GALFER
FK
0430

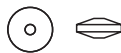

CONIC INVERSOR • INVERSOR CÓNICO
INVERTITORE CONICO • INVERSEUR CONIQUE

THREAD • PASO ROSCA FILETTO • FILL	SILVER BRASS • LATÓN PLATA OTTONE ARGENTO • LAITON ARGENT
	FK003D0430 (3.5 x 8 mm)

KITS KG

GALFER
FK
010



WASHER • ARANDELA
RONDELLA • RONDELLE

THREAD • PASO ROSCA FILETTO • FILL	SILVER BRASS • LATÓN PLATA OTTONE ARGENTO • LAITON ARGENT
	FK003D010A (14x10x1mm)

CROSS REFERENCE



THREAD · PASO ROSCA FILETTO · FILL	SILVER BRASS · LATÓN PLATA OTTONE ARGENTO · LAITON ARGENT
10 mm	FK003D7020
12 mm	FK013D7021

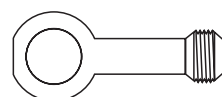

K7 STRAIGHT BANJO · BANJO RECTO K7
RACCORDO DRITTO K7 · BANJO DROIT K7

GALFER
FK
7020

THREAD · PASO ROSCA FILETTO · FILL	SILVER BRASS · LATÓN PLATA OTTONE ARGENTO · LAITON ARGENT
10 mm	FK003D7030
12 mm	FK013D7031



12° K7 BANJO · BANJO 12° K7
RACCORDO 12° K7 · BANJO 12° K7

GALFER
FK
7030

THREAD · PASO ROSCA FILETTO · FILL	SILVER BRASS · LATÓN PLATA OTTONE ARGENTO · LAITON ARGENT
10 mm	FK003D7401

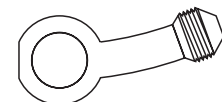

20° K7 LATERAL BANJO · BANJO LATERAL 20° K7
RACCORDO LATERALE 20° K7 · BANJO LATÉRAL 20° K7

GALFER
FK
7401

THREAD · PASO ROSCA FILETTO · FILL	SILVER BRASS · LATÓN PLATA OTTONE ARGENTO · LAITON ARGENT
10 mm	FK003D704C
12 mm	FK013D705C



40° K7 SHORT BANJO · BANJO CORTO 40° K7
RACCORDO CORTO 40° K7 · BANJO COURT 40° K7

GALFER
FK
704C

THREAD · PASO ROSCA FILETTO · FILL	SILVER BRASS · LATÓN PLATA OTTONE ARGENTO · LAITON ARGENT
10 mm	FK003D728C
12 mm	FK013D729C

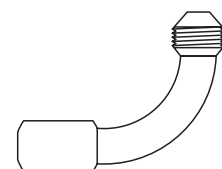

90° K7 SHORT BANJO · BANJO CORTO 90° K7
RACCORDO CORTO 90° K7 · BANJO COURT 90° K7

GALFER
FK
728C

THREAD · PASO ROSCA FILETTO · FILL	SILVER BRASS · LATÓN PLATA OTTONE ARGENTO · LAITON ARGENT
10 mm	FK002D728L
12 mm	

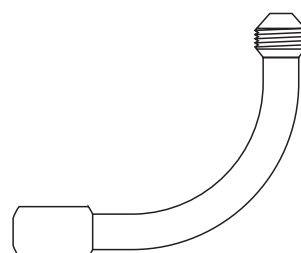

90° K7 LONG BANJO · BANJO LARGO 90° K7
RACCORDO LUNGO 90° K7 · BANJO LONG 90° K7

GALFER
FK
728L



APPLICATIONS

GALFER
FK
732

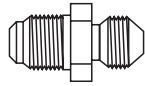

K7 ADAPTER • ADAPTADOR K7
ADATTATORE K7 • ADAPTATEUR K7

THREAD • PASO ROSCA FILETTO • FILL	SILVER BRASS • LATÓN PLATA OTTONE ARGENTO • LAITON ARGENT
10 x 100	FK003D732A
10 x 125	FK003D732B
3/8	FK003D732C
1/8	FK003D732D

PADS

GALFER
FK
7024

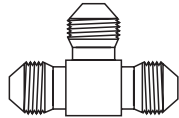

K7 3 WAY HOSE FITTING • REPARTIDOR 3 VÍAS K7
RIPARTITORE A 3 VIE K7 • RÉPARTITEUR 3 VOIES K7

THREAD • PASO ROSCA FILETTO • FILL	SILVER BRASS • LATÓN PLATA OTTONE ARGENTO • LAITON ARGENT
	FK003D7024

DISCS

GALFER
FK
K7



K7 HOSES • TUBERÍA K7
TUBI FRENO K7 • DURITES K7

REF.	SIZE
FK015*	15 cm
FK025*	25 cm
FK030*	30 cm
FK035*	35 cm
FK040*	40 cm
FK045*	45 cm
FK050*	50 cm
FK055*	55 cm
FK060*	60 cm
FK065*	65 cm
FK070*	70 cm
FK075*	75 cm
FK080*	80 cm
FK085*	85 cm
FK090*	90 cm
FK095*	95 cm
FK100*	100 cm
FK105*	105 cm
FK110*	110 cm
FK120*	120 cm
FK130*	130 cm
FK140*	140 cm
FK150*	150 cm
FK160*	160 cm
FK170*	170 cm
FK180*	180 cm
FK190*	190 cm
FK200*	200 cm

REF.	COLOUR
*K0011	Black Negro Nero Noir
*K0012	Transparent Transparente Transparente Transparent
*K0020	Red Rojo Rosso Rouge
*K0031	Carbon Carbono Carbonio Carbon

SHOES

LINEAS

BRACKETS

KITS

CROSS REFERENCE



ACCESSORIES · ACCESORIOS

ACCESSORI · ACCESSOIRES

GALFER
FK
005/6



PVC SHEATH · VAINA PVC
GUAINA PVC · ÉTUIL PVC

SIZE	COLOUR	REF.
7 X 10	BLACK	FK000D005A
7 X 10	WHITE	FK000D005B
8 X 10	BLACK	FK000D006A
8 X 10	WHITE	FK000D006B
8.5 X 10	WHITE	FK000D007B
8 X 10	WHITE COARSE	FK000D006C
8 X 11.5	WHITE COARSE	FK000D006D

GALFER
FK
035

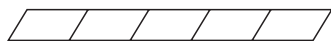

SPIRAL BINDING · PROTECTOR HELICOIDAL
RILEGATURE · PROTECTEUR HÉLICOÏDAL

SIZE	COLOUR	REF.
4 x 12	WHITE	FK000D035A
4 x 12	BLACK	FK000D035B

GALFER
FK
903



RUBBER DUST COVER · GUARDAPOLVO GOMA
PROTEZIONE ANTIPOLVERE DI GOMMA · CACHE-POUSSIÈRE GOMME

SIZE	COLOUR	REF.
37 x ø 9.5 x ø 5	BLACK	FK000D903E

GALFER
FK
904

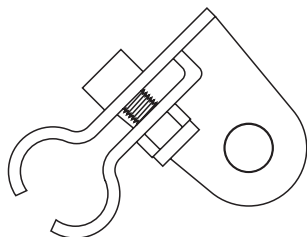

90° SHEATH CLAMP · BRIDA VAINA 90°
MORSETTO RIVESTIMENTO 90° · BRIDE ÉTUIL 90°

SIZE	COLOUR	REF.
	WHITE	FK003D904A(Fe)
	BLACK	FK003D904B(Fe)

GALFER
FK
905

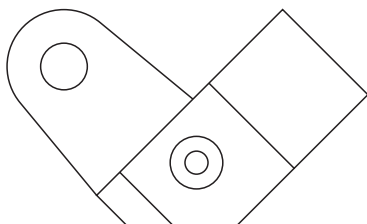

STRAIGHT SHEATH CLAMP · BRIDA VAINA RECTA
MORSETTO RIVESTIMENTO DRITTO · BRIDE ÉTUIL DROIT

SIZE	COLOUR	REF.
	WHITE	FK003D905A(Fe)
	BLACK	FK003D905B(Fe)

Team Yamaha SM Action
Henry Jacobi (MXGP)
Maxime Renaux (MX2)



CHAMPION'S CHOICE

*Upgrade your
off-road brake
system.*

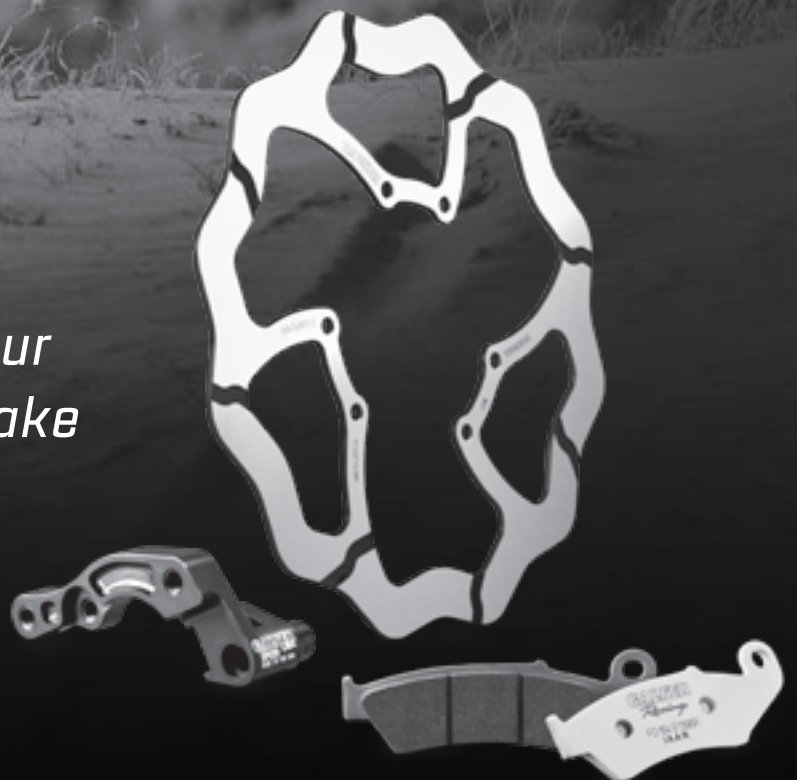

BRACKETS FOR CALIPER
SOPORTES PARA PINZA

SUPPORTI PINZA

SUPPORTS ÉTRIER

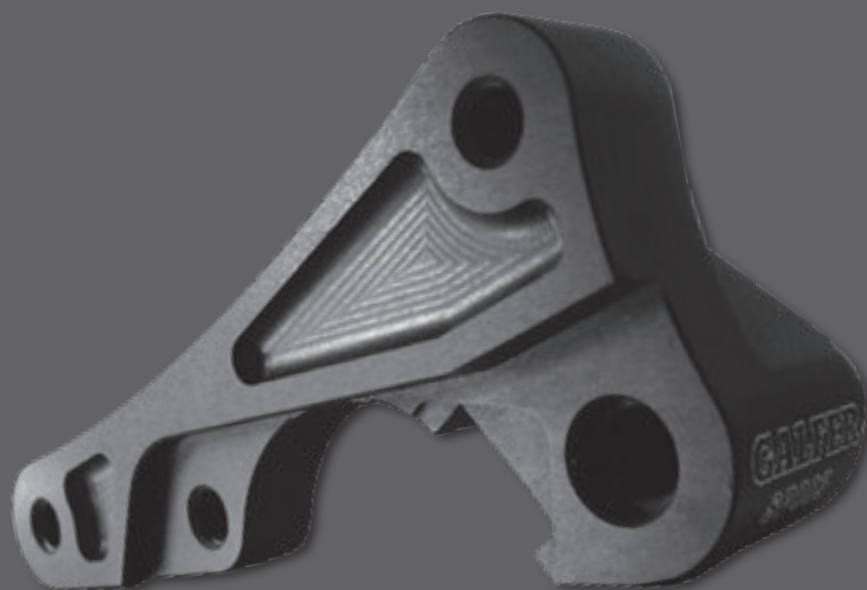



APPLICATIONS

GALFER
SP
001

Scooter
Off-Road
Street
Sport&GP

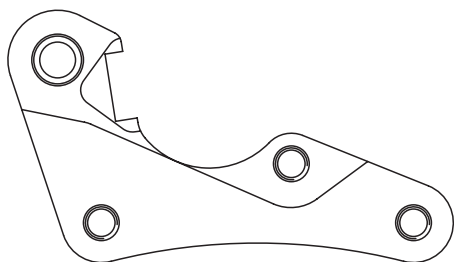

BRAND & MODEL MARCA Y MODELO	C.C.	YEAR	øext.	FRONT DF
HONDA				
CRF 250 R / X	250	04 14	270	DF014FLS
CRF 450 F / R	450	04 14	270	DF014FLS

PADS FD

GALFER
SP
003

Scooter
Off-Road
Street
Sport&GP

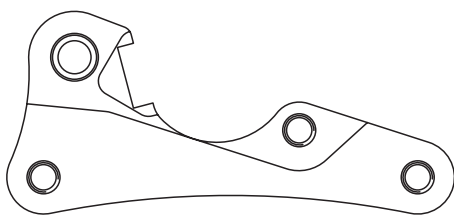

BRAND & MODEL MARCA Y MODELO	C.C.	YEAR	øext.	FRONT DF
HM				
CRE 125 R	125	03	260	DF082FLW
CRE 250 F / R	250	03	260	DF082FLW
CRE 450 F	450	03	260	DF082FLW
HONDA				
CR 125 R	125	98 14	260	DF082FLW
CR 250 R	250	97 14	260	DF082FLW
CRF 450 F / R	450	01 03	260	DF082FLW

DISCS DF

GALFER
SP
004

Scooter
Off-Road
Street
Sport&GP

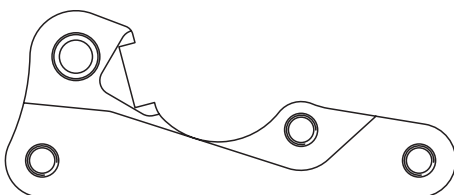

BRAND & MODEL MARCA Y MODELO	C.C.	YEAR	øext.	FRONT DF
YAMAHA				
YZ 125, WR	125	98 07	270	DF301FLS
YZ 250 F, WR F 4T	250	00 06	270	DF301FLS
YZ 250, WR	250	99 07	270	DF301FLS
WR 400 F / YZ 400 F	400	99 99	270	DF301FLS
WR 426 F / YZ 426 F	425	00 02	270	DF301FLS
WR 450 F	450	03	270	DF301FLS
YZ 450 F	450	03 07	270	DF301FLS

SHOES MF

GALFER
SP
005

Scooter
Off-Road
Street
Sport&GP

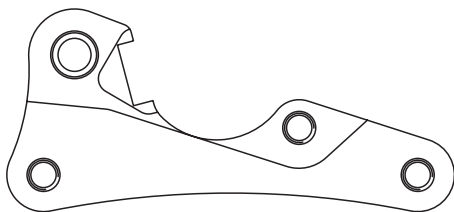

BRAND & MODEL MARCA Y MODELO	C.C.	YEAR	øext.	FRONT DF
KAWASAKI				
KX (All cc)	-	95 02	270	DF150FLS
KX / F (All cc)	-	03 05	270	DF182FLS
KX / F (All cc)	-	06 15	270	DF200FLS
SUZUKI				
RM (All cc)	-	00	270	DF301FLS
RMZ 250	250	04 05	270	DF182FLS
RMZ 250	250	06	270	DF349FLS
RMZ 450	450	06 17	270	DF349FLS

LINES FK

GALFER
SP
012

Scooter
Off-Road
Street
Sport&GP

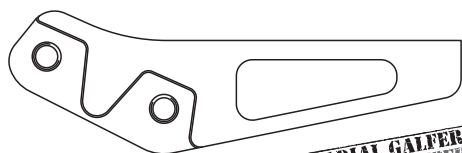

**PARA PINZA RADIAL GALFER
FOR GALFER RADIAL CALIPER**

BRAND & MODEL MARCA Y MODELO	C.C.	YEAR	øext.	FRONT DF
HONDA				
DYLAN (Galfer radial caliper)	125	02	240	DF007W
SH 125 (Galfer radial caliper)	125	05	240	DF007W
SH 150 (Galfer radial caliper)	150	05	240	DF007W
YAMAHA				
SH 125 SCOOPY (Galfer radial caliper)	125	01	260	DF071WS
SH 125i SCOOPY (Galfer radial caliper)	125	05	260	DF071WS
SH 150 SCOOPY (Galfer radial caliper)	150	01	260	DF071WS
SH 150i SCOOPY (Galfer radial caliper)	150	05	260	DF071WS

BRACKETS SP

GALFER
SP
015

Scooter
Off-Road
Street
Sport&GP

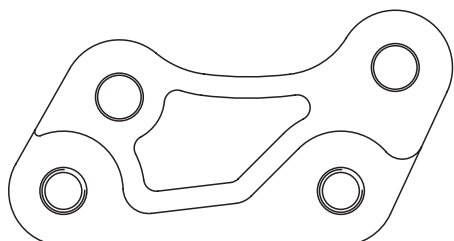

BRAND & MODEL MARCA Y MODELO	C.C.	YEAR	øext.	FRONT DF
YAMAHA				
CYGNUS 125 X	50	03	260	DF504FLS

CROSS REFERENCE



BRAND & MODEL MARCA Y MODELO	C.C.	YEAR	Øext.	FRONT DF
KTM				
All < 640 cc	-	00 09	270	DF606FLS
HUSABERG				
All 400 - 650 cc	-	00 09	270	DF606FLS
HUSQVARNA				
125 & 250 CR / TC / TE	-	00	270	DF635FLS
TE 410	410	00	270	DF635FLS
450 TC / TE	450	05	270	DF635FLS
510 TC / TE	510	00	270	DF635FLS

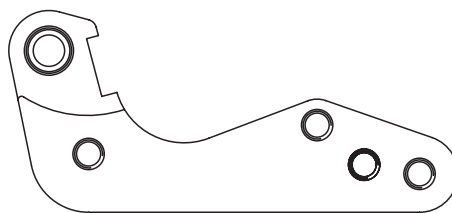

GALFER
SP 021

Scooter
Off-Road
Street
Sport&GP

BRAND & MODEL MARCA Y MODELO	C.C.	YEAR	Øext.	FRONT DF
YAMAHA				
YZ 250 F	250	07	270	DF301FLS
YZ 450 F	450	08	270	DF301FLS

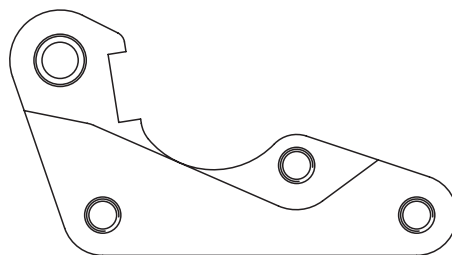

GALFER
SP 023

Scooter
Off-Road
Street
Sport&GP

BRAND & MODEL MARCA Y MODELO	C.C.	YEAR	Øext.	FRONT DF
GAS GAS				
EC / MC 125	125	01	270	DF677FLS
EC 200	200	01	270	DF677FLS
EC / MC 250	250	01	270	DF677FLS
EC 250 FSE	250	01	270	DF677FLS
EC 300	300	01	270	DF677FLS
EC 400 FSE	400	01	270	DF677FLS
PAMPERA 400	400	06	270	DF677FLS
EC 450 FSE	450	03	270	DF677FLS

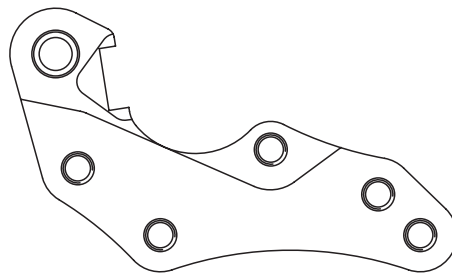

GALFER
SP 027

Scooter
Off-Road
Street
Sport&GP

BRAND & MODEL MARCA Y MODELO	C.C.	YEAR	Øext.	FRONT DF
HONDA				
CRF 150 R	150	07	260	DF050FLX

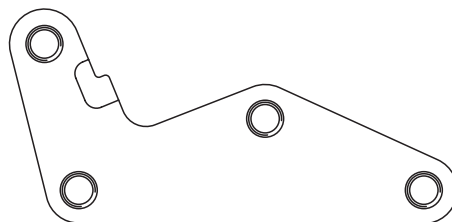

GALFER
SP 029

Scooter
Off-Road
Street
Sport&GP

BRAND & MODEL MARCA Y MODELO	C.C.	YEAR	Øext.	FRONT DF
YAMAHA				
YZ 125, WR	125	98 07	298	DF301FLX
YZ 250 F, WR F 4T	250	00 06	298	DF301FLX
YZ 250, WR	250	99 07	298	DF301FLX
WR 400 F / YZ 400 F	400	99 99	298	DF301FLX
WR 426 F / YZ 426 F	425	00 02	298	DF301FLX
WR 450 F	450	03	298	DF301FLX
YZ 450 F	450	03 07	298	DF301FLX

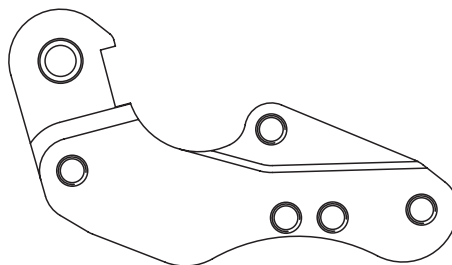

GALFER
SP 031

Scooter
Off-Road
Street
Sport&GP

BRAND & MODEL MARCA Y MODELO	C.C.	YEAR	Øext.	FRONT DF
KTM				
All cc	-	10	270	DF606FLS/FRS/WS
HUSQVARNA				
All cc	-	14	270	DF606FLS/FRS/WS

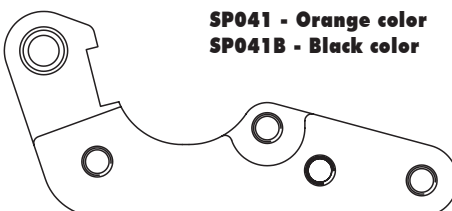

SP041 - Orange color
SP041B - Black color

GALFER
SP 041

Scooter
Off-Road
Street
Sport&GP

APPLICATIONS

PADS FD

DISCS DF

SHOES MF

LINES FK

BRACKETS SP

KITS KG

CROSS REFERENCE



APPLICATIONS

PADS FD

DISCS DF

SHOES MF

LINES FK

BRACKETS SP

KITS KG

CROSS REFERENCE

GALFER
SP
041

Scooter
Off-Road
Street
Sport&GP

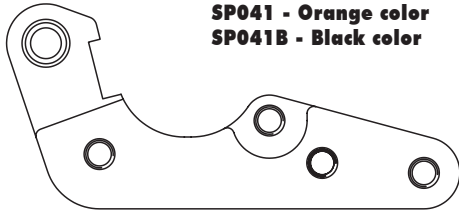

SP041 - Orange color
SP041B - Black color

BRAND & MODEL MARCA Y MODELO	C.C.	YEAR	øext.	FRONT DF
KTM				
All cc	-	10	270	DF606FLS/FRS/WS
HUSQVARNA				
All cc	-	14	270	DF606FLS/FRS/WS

GALFER
SP
043

Scooter
Off-Road
Street
Sport&GP

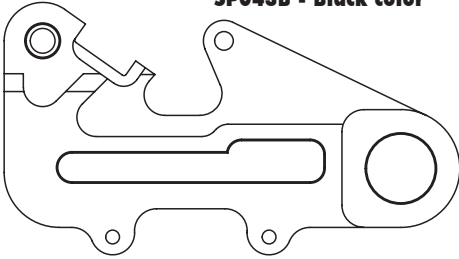

SP043 - Orange color
SP043B - Black color

BRAND & MODEL MARCA Y MODELO	C.C.	YEAR	øext.	REAR DF
KTM				
All cc	-	10	240	DF607WS / RWS
HUSQVARNA				
All cc	-	14	240	DF607WS / RWS

GALFER
SP
045

Scooter
Off-Road
Street
Sport&GP

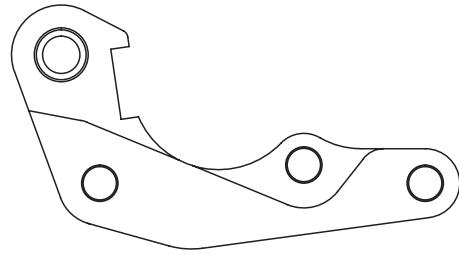

BRAND & MODEL MARCA Y MODELO	C.C.	YEAR	øext.	FRONT DF
HONDA				
CRF 250 R / X	250	15 18	270	DF014FLS
CRF 450 F / R	450	15 18	270	DF014FLS

GALFER
SP
047

Scooter
Off-Road
Street
Sport&GP

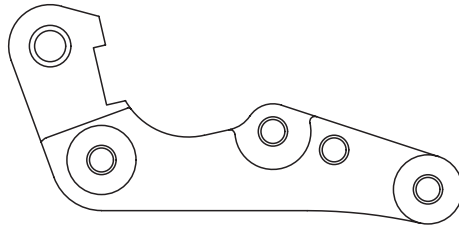

BRAND & MODEL MARCA Y MODELO	C.C.	YEAR	øext.	FRONT DF
SHERCO				
250/300/450 SE FORK WP	ALL	14	270	DF772FRW
250/300/450 SE-R FORK WP	ALL	14	270	DF772FRW
250/300/450 SEF-R FORK WP	ALL	14	270	DF772FRW

GALFER
SP
048

Scooter
Off-Road
Street
Sport&GP

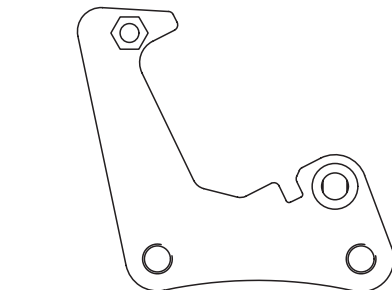

BRAND & MODEL MARCA Y MODELO	C.C.	YEAR	øext.	FRONT DF
YAMAHA				
N MAX 125	125	15	267	DF534FLS
N MAX 150	150	15	267	DF534FLS

GALFER
SP
049

Scooter
Off-Road
Street
Sport&GP

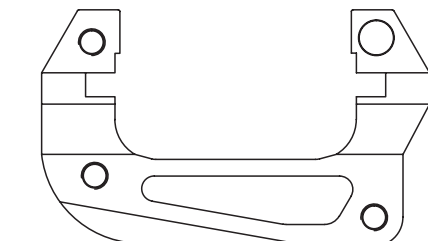

BRAND & MODEL MARCA Y MODELO	C.C.	YEAR	øext.	FRONT DF
YAMAHA				
YZ 85	85	03	250	DF489WS / RWS



BRAND & MODEL MARCA Y MODELO	C.C.	YEAR	Øext.	FRONT DF
YAMAHA				
YZ 125	125	18	280	DF298RWS
YZ 250 F	250	16	280	DF298RWS
YZ 450 F	450	16	280	DF298RWS

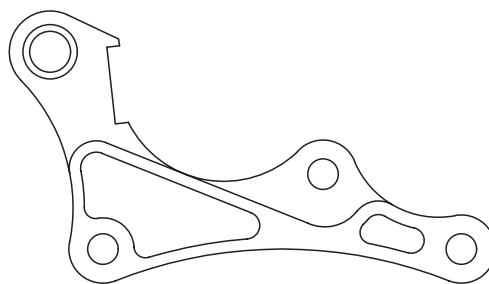

GALFER
SP
056

Scooter
Off-Road
Street
Sport&GP

BRAND & MODEL MARCA Y MODELO	C.C.	YEAR	Øext.	FRONT DF
KAWASAKI				
KX 250 F	250	15	280	DF208RWS
KX 450 F	450	15	280	DF208RWS
SUZUKI				
RMX 450 Z	450	18	280	DF368RWS

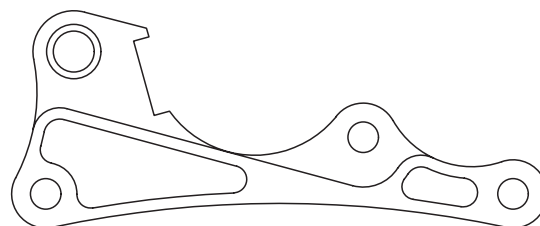

GALFER
SP
057

Scooter
Off-Road
Street
Sport&GP

BRAND & MODEL MARCA Y MODELO	C.C.	YEAR	Øext.	FRONT DF
KTM				
All cc	-	10	280	DF606RWZ

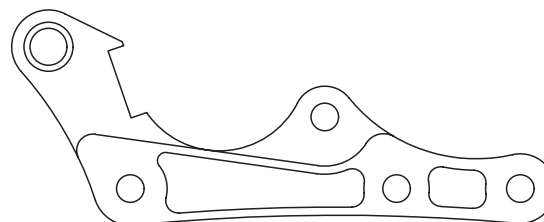

GALFER
SP
058

Scooter
Off-Road
Street
Sport&GP

BRAND & MODEL MARCA Y MODELO	C.C.	YEAR	Øext.	FRONT DF
HONDA				
CRF 250 R / X	250	19	270	DF014FLS
CRF 450 F / R	450	19	270	DF014FLS

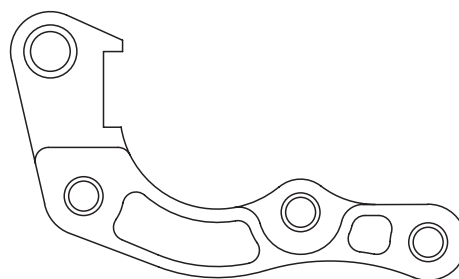

GALFER
SP
059

Scooter
Off-Road
Street
Sport&GP

BRAND & MODEL MARCA Y MODELO	C.C.	YEAR	Øext.	FRONT DF
HONDA				
CRF 250 R / X	250	15	280	DF082RWZ
CRF 450 F / R	450	15	280	DF082RWZ

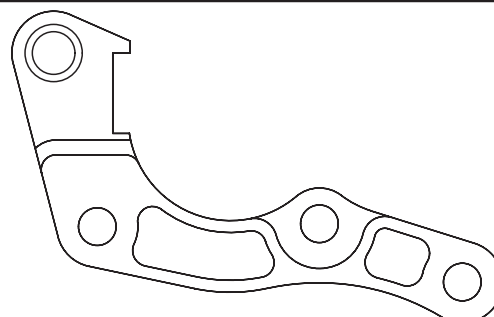

GALFER
SP
060

Scooter
Off-Road
Street
Sport&GP

BRAND & MODEL MARCA Y MODELO	C.C.	YEAR	Øext.	FRONT DF
HONDA				
CR / CRF Brembo caliper	250	03	320	DF014SM
CR / CRF Brembo caliper	450	03	320	DF014SM

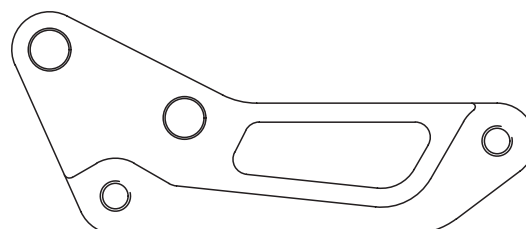

GALFER
SP
301

Scooter
Off-Road
Street
Sport&GP

APPLICATIONS

PADS FD

DISCS DF

SHOES MF

LINES FK

BRACKETS SP

KITS KG

CROSS REFERENCE



APPLICATIONS

PADS FD

DISCS DF

SHOES MF

LINES FK

BRACKETS SP

KITS KG

CROSS REFERENCE

GALFER
SP
475

Scooter
Off-Road
Street
Sport&GP

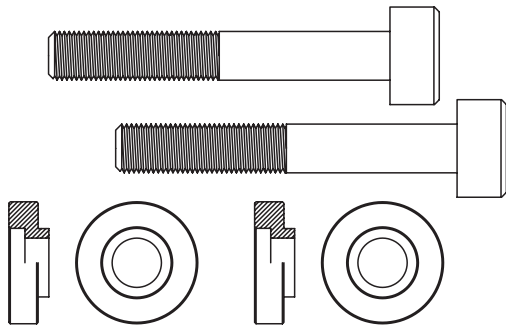

BRAND & MODEL MARCA Y MODELO	C.C.	YEAR	øext.	FRONT DF
YAMAHA				
XP 530 T-MAX	530	15	298	DF495CWR

GALFER
SP
498

Scooter
Off-Road
Street
Sport&GP

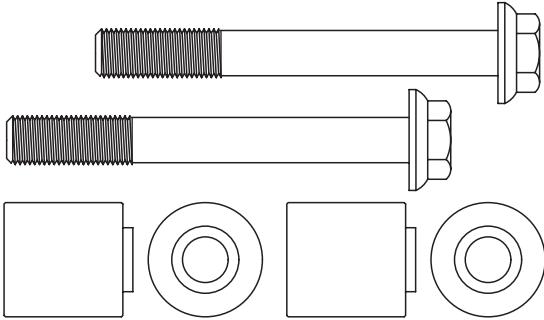

BRAND & MODEL MARCA Y MODELO	C.C.	YEAR	øext.	FRONT DF
YAMAHA				
XP 530 T-MAX	530	15	320	DF475CW

GALFER
SP
707

Scooter
Off-Road
Street
Sport&GP

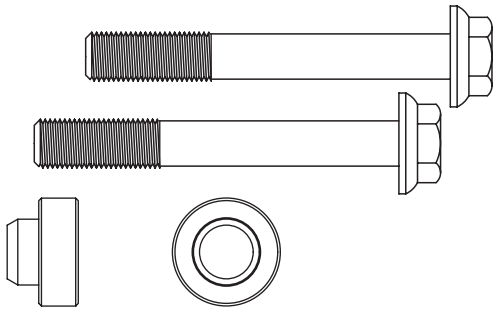

BRAND & MODEL MARCA Y MODELO	C.C.	YEAR	øext.	FRONT DF
BMW				
R 1200 GS / C (ALL)	1200	00	320	DF707W

GALFER
SP
794

Scooter
Off-Road
Street
Sport&GP

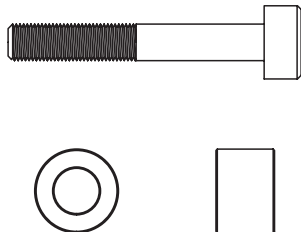

BRAND & MODEL MARCA Y MODELO	C.C.	YEAR	øext.	FRONT DF
KTM				
85 SX 19/16	85	13	260	DF794RWS

BRAKE KITS
KITS DE FRENO

KITS FRENO
KITS DE FREIN





APPLICATIONS

PADS FD

DISCS DF

SHOES MF

LINES FK

BRACKETS SP

KITS KG

CROSS REFERENCE

GALFER KIT									
APPLICATION ° APLICACIÓN	WHEEL	DF SIZE	FD FRONT	N° DF	DF FRONT	SP FRONT	FD REAR	DF REAR	

DESCRIPTION · DESCRIPCIÓN · DESCRIZIONE · DESCRIPTION

- 1** Galfer brake Kit reference
Referencia del Kit de freno Galfer
Riferimento Kit freno Galfer
Référence kit de frein Galfer
- 2** Brand & model of the motorcycle
Marca y modelo de la moto
Marca e modello del motociclo
Marque et modèle de la moto
- 3** Kit brake application
Aplicación del Kit de freno
Applicazione freno Kit
Kit de freinage
- 4** Front brake disc measure
Medida del disco de freno delantero
Misurare il disco freno anteriore
Mesurer le disque de frein avant
- 5** Complete brake pads reference
Referencia completa de las pastillas de freno
Riferimento complete pastiglie freno
Référence complète plaquettes de frein
- 6** Number of front brake discs
Número de discos de freno delanteros
Numero di dischi freno anteriori
Nombre de disques de frein avant
- 7** Complete brake disc reference
Referencia completa del disco de freno
Riferimento completedisco freno
Référence complète plaquettes de frein
- 8** Bracket for caliper reference
Referencia del soporte para pinza
Riferimento support pinza
Référence support étrier



GALFER KIT	APPLICATION · APLICACIÓN	WHEEL	DF SIZE	FD FRONT	N° DF	DF FRONT	SP	FD REAR	DF REAR
KG0062FS	Honda SH 300 ø296mm (07-14)	Front & Rear	OS	FD344G1375	1	DF006W	SP035	FD345G1054	DF083W
KG006WFS	Honda SH 300 ø296mm (07-14)	Front	OS	FD344G1375	1	DF006W	SP035	-	-
KG0072FS	Honda SH 125-150 (DD)	Front & Rear	OS	FD344G1380	1	DF007W	SP035	FD345G1054	DF007W
KG007WFS	Honda SH 125-150 (DD) ø280mm	Front	OS	FD344G1380	1	DF007WS	SP035	-	-
KG014RFS	Honda CR / CRF (-2014) ø270mm	Front	OS	FD164G1396	1	DF014FRS	SP001	-	-
KG014RWS	Honda CR / CRF (-2014) ø270mm	Front	OS	FD164G1396	1	DF014RWS	SP001	-	-
KG014W	HONDA	Front & Rear	OE	FD164G1396	1	DF014W	-	FD278G1396	DF069W
KG014WFS	Honda CR / CRF (-2014) ø270mm	Front	OS	FD164G1396	1	DF014FLS	SP001	-	-
KG014WS	Honda CR / CRF (-2014) ø270mm	Front	OS	FD164G1396	1	DF082WS	SP001	-	-
KG078WF	Honda PCX / Vision	Front	OE	FD439G1383	1	DF078W	-	-	-
KG082RFS	Honda CRF (2015-2018) ø270mm	Front	OS	FD164G1396	1	DF014FRS	SP045	-	-
KG082RFS2	Honda CRF (2019-) ø270mm	Front	OS	FD164G1396	1	DF014FRS	SP059	-	-
KG082RWS	Honda CRF (2015-2018) ø270mm	Front	OS	FD164G1396	1	DF014RWS	SP045	-	-
KG082RWS2	Honda CRF (2019-) ø270mm	Front	OS	FD164G1396	1	DF014RWS	SP059	-	-
KG082RWSX	Honda (2014-) ø280mm	Front	OS	FD164G1396R	1	DF082RWSX	SP060	-	-
KG082W	HONDA	Front & Rear	OE	FD164G1396	1	DF082W	-	FD278G1396	DF069W
KG082WFS	Honda CRF (2015-2018) ø270mm	Front	OS	FD164G1396	1	DF014FLS	SP045	-	-
KG082WFS2	Honda CRF (2019-) ø270mm	Front	OS	FD164G1396	1	DF014FLS	SP059	-	-
KG082WS	Honda CRF (2015-2018) ø270mm	Front	OS	FD164G1396	1	DF082WS	SP045	-	-
KG082WS2	Honda CRF (2019-) ø270mm	Front	OS	FD164G1396	1	DF082WS	SP059	-	-
KG083WF	Honda SH 300	Front	OE	FD344G1054	1	DF083W	-	-	-
KG149W	KAWASAKI 2019 -	Front & Rear	OE	FD164G1396	1	DF208W	-	FD286G1396	DF149W
KG200RFS	Kawasaki KX (-2014) ø270mm	Front	OS	FD164G1396	1	DF200FRS	SP005	-	-
KG200RWS	Kawasaki KX (-2014) ø270mm	Front	OS	FD164G1396	1	DF208RW	SP005	-	-
KG200WFS	Kawasaki KX (-2014) ø270mm	Front	OS	FD164G1396	1	DF200FLS	SP005	-	-
KG200WS	Kawasaki KX (-2014) ø270mm	Front	OS	FD164G1396	1	DF208W	SP005	-	-
KG208RWSX	Kawasaki (2015-) ø280mm	Front	OS	FD164G1396R	1	DF208RWSX	SP057	-	-
KG208W	KAWASAKI	Front & Rear	OE	FD164G1396	1	DF208W	-	FD286G1396	DF179W
KG298RWSX	Yamaha (2015-) ø280mm	Front	OS	FD364G1396R	1	DF298RWSX	SP056	-	-
KG298W	YAMAHA	Front & Rear	OE	FD364G1396	1	DF298W	-	FD286G1396	DF499W
KG301RFS	Yamaha YZF ø270mm	Front	OS	FD364G1396	1	DF298FRW	SP023	-	-
KG301RWS	Yamaha YZF ø270mm	Front	OS	FD364G1396	1	DF298RW	SP023	-	-
KG301WFS	Yamaha YZF ø270mm	Front	OS	FD364G1396	1	DF298FLW	SP023	-	-
KG301WS	Yamaha YZF ø270mm	Front	OS	FD364G1396	1	DF301WS	SP023	-	-
KG349RFS	Suzuki RMZ ø270mm	Front	OS	FD164G1396	1	DF349FRS	SP005	-	-
KG349RWS	Suzuki RMZ ø270mm	Front	OS	FD164G1396	1	DF349RWS	SP005	-	-
KG349WFS	Suzuki RMZ ø270mm	Front	OS	FD164G1396	1	DF349FLS	SP005	-	-
KG349WS	Suzuki RMZ ø270mm	Front	OS	FD164G1396	1	DF349WS	SP005	-	-
KG368RWSX	Suzuki (2018-) ø280mm	Front	OS	FD164G1396R	1	DF368RWSX	SP057	-	-
KG368W	SUZUKI	Front & Rear	OE	FD164G1396	1	DF368W	-	FD286G1396	DF350W
KG489RWS	Yamaha YZ 85 ø250mm	Front	OS	FD097G1054	1	DF489RWS	SP049	-	-
KG489WS	Yamaha YZ 85 ø250mm	Front	OS	FD097G1054	1	DF489WS	SP049	-	-
KG495BFS	Yamaha T-MAX 530 (2015-) / 560 (2020-) ø298mm	Front & Rear	OS	FD178G1375	2	DF460CW	SP475	FD260G1380	DF528W
KG495CFS	Yamaha T-MAX 530 (2015-) / 560 (2020-) ø298mm	Front	OS	FD178G1375	2	DF460CW	SP475	-	-
KG4983FS	Yamaha T-MAX 530 (2015-) / 560 (2020-) ø320mm	Front & Rear	OS	FD178G1375	2	DF475CW	SP498	FD260G1380	DF528W
KG500WF	Yamaha X-MAX 125-250	Front & Rear	OE	FD266G1380	1	DF500W	-	FD214G1380	DF524W
KG5033F	Yamaha T-MAX 500 (04-07)	Front & Rear	OE	FD169G1380	2	DF503FLW	-	FD352G1380	DF494W
KG5033FLW	Yamaha X-MAX 400	Front & Rear	OE	FD266G1370	2	DF503FLW	-	FD474G1380	DF501W
KG503CF	Yamaha T-MAX 530	Front & Rear	OE	FD178G1370	2	DF503FLW	-	FD260G1380	DF528W
KG515W	YAMAHA 2018 -	Front & Rear	OE	FD364G1396	1	DF298W	-	FD286G1396	DF515W
KG5262F	Yamaha YZF 125 R	Front & Rear	OE	FD138G1054	1	DF526W	-	FD336G1054	DF527W
KG5341FS	Yamaha N MAX 125/150	Front	OS	FD503G1380	1	DF534FLS	SP048	-	-
KG606RFS	KTM (2010-) - Husqvarna (2014-) ø270mm	Front	OS	FD138G1396	1	DF606FRS	SP041	-	-
KG606RWS	KTM (2010-) - Husqvarna (2014-) ø270mm	Front	OS	FD138G1396	1	DF606RWS	SP041	-	-
KG606RWSX	KTM (2010-) - Husqvarna (2014-) ø280mm	Front	OS	FD138G1396R	1	DF606RWSX	SP058	-	-
KG606W	KTM-HUSQV.	Front & Rear	OE	FD138G1396	1	DF606W	-	FD291G1396	DF607W
KG606WFS	KTM (2010-) - Husqvarna (2014-) ø270mm	Front	OS	FD138G1396	1	DF606FLS	SP041	-	-
KG606WLL	KTM-HUSQV.	Front & Rear	OE	FD138G1396	1	DF606W	-	FD291G1396	DF607WLL
KG606WS	KTM (2010-) - Husqvarna (2014-) ø270mm	Front	OS	FD138G1396	1	DF606WS	SP041	-	-
KG607RWS	KTM (2010-) - Husqvarna (2014-) ø240mm	Rear	OS	-	1	-	SP043	FD291G1396	DF607RWS
KG607WS	KTM (2010-) - Husqvarna (2014-) ø240mm	Rear	OS	-	1	-	SP043	FD291G1396	DF607WS
KG677RFS	Gas Gas ø270mm	Front	OS	FD164G1396	1	DF677FRS	SP027	-	-
KG677WFS	Gas Gas ø270mm	Front	OS	FD164G1396	1	DF677FLS	SP027	-	-
KG7022F	BMW R 1200 GS	Front	OE	FD271G1375	2	DF702W	-	-	-
KG7023F	BMW R 1200 GS	Front & Rear	OE	FD271G1375	2	DF702W	-	FD186G1371	DF763W
KG702WFS	BMW R 1200 GS LC (2013-)	Front	OS	FD475G1370	2	DF707W	SP707	-	-
KG794RWS	KTM 85 SX 260mm	Front	OS	FD458G1396	1	DF794RWS	SP794	-	-
KG814W	BETA	Front & Rear	OE	FD164G1396	1	DF814W	-	FD456G1396	DF815W
KG8163F	BMW C 600 Sport	Front & Rear	OE	FD266G1370	2	DF816FLW	-	FD266G1370	DF816W
KG828W	TM	Front & Rear	OE	FD138G1396	1	DF828W	-	FD286G1396	DF840W

OE: Original equipment (original replacement disc) · Equipo original (disco de reemplazo del original) · Attrezzatura originale (disco sostitutivo originale) · Équipement d'origine (disque de remplacement d'origine)

OS: Oversized disc (needs bracket to adapt the brake caliper) · Disco sobremedida (necesita soporte para adaptar la pinza de freno) · Disco maggiorato (necessita di supporto per adattare la pinza del freno) · Disque oversized (nécessite un support pour adapter l'étrier de frein)



APPLICATION * APLICACIÓN	GALFER KIT	WHEEL	DF SIZE	FD FRONT	Nº DF	DF FRONT	SP	FD REAR	DF REAR
BETA	KG814W	Front & Rear	OE	FD164G1396	1	DF814W	-	FD456G1396	DF815W
BMW C 600 Sport	KG8163F	Front & Rear	OE	FD266G1370	2	DF816FLW	-	FD266G1370	DF816W
BMW R 1200 GS	KG7022F	Front	OE	FD271G1375	2	DF702W	-	-	-
BMW R 1200 GS	KG7023F	Front & Rear	OE	FD271G1375	2	DF702W	-	FD186G1371	DF763W
BMW R 1200 GS LC (2013-)	KG702WFS	Front	OS	FD475G1370	2	DF707W	SP707	-	-
Gas Gas ø270mm	KG677RFS	Front	OS	FD164G1396	1	DF677RFS	SP027	-	-
Gas Gas ø270mm	KG677WFS	Front	OS	FD164G1396	1	DF677FLS	SP027	-	-
HONDA	KG014W	Front & Rear	OE	FD164G1396	1	DF014W	-	FD278G1396	DF069W
HONDA	KG082W	Front & Rear	OE	FD164G1396	1	DF082W	-	FD278G1396	DF069W
Honda (2014-) ø280mm	KG082RWSX	Front	OS	FD164G1396R	1	DF082RWSX	SP060	-	-
Honda CR / CRF (-2014) ø270mm	KG014RFS	Front	OS	FD164G1396	1	DF014FRS	SP001	-	-
Honda CR / CRF (-2014) ø270mm	KG014RWS	Front	OS	FD164G1396	1	DF014RWS	SP001	-	-
Honda CR / CRF (-2014) ø270mm	KG014WFS	Front	OS	FD164G1396	1	DF014FLS	SP001	-	-
Honda CR / CRF (-2014) ø270mm	KG014WS	Front	OS	FD164G1396	1	DF082WS	SP001	-	-
Honda CRF (2015-2018) ø270mm	KG082RFS	Front	OS	FD164G1396	1	DF014FRS	SP045	-	-
Honda CRF (2015-2018) ø270mm	KG082RWS	Front	OS	FD164G1396	1	DF014RWS	SP045	-	-
Honda CRF (2015-2018) ø270mm	KG082WFS	Front	OS	FD164G1396	1	DF014FLS	SP045	-	-
Honda CRF (2015-2018) ø270mm	KG082WS	Front	OS	FD164G1396	1	DF082WS	SP045	-	-
Honda CRF (2019-) ø270mm	KG082RFS2	Front	OS	FD164G1396	1	DF014FRS	SP059	-	-
Honda CRF (2019-) ø270mm	KG082RWS2	Front	OS	FD164G1396	1	DF014RWS	SP059	-	-
Honda CRF (2019-) ø270mm	KG082WFS2	Front	OS	FD164G1396	1	DF014FLS	SP059	-	-
Honda CRF (2019-) ø270mm	KG082WS2	Front	OS	FD164G1396	1	DF082WS	SP059	-	-
Honda PCX / Vision	KG078WF	Front	OE	FD439G1383	1	DF078W	-	-	-
Honda SH 125-150 (DD)	KG0072FS	Front & Rear	OS	FD344G1380	1	DF007W	SP035	FD345G1054	DF007W
Honda SH 125-150 (DD) ø280mm	KG007WFS	Front	OS	FD344G1380	1	DF007WS	SP035	-	-
Honda SH 300	KG083WF	Front	OE	FD344G1054	1	DF083W	-	-	-
Honda SH 300 ø296mm (07-14)	KG0062FS	Front & Rear	OS	FD344G1375	1	DF006W	SP035	FD345G1054	DF083W
Honda SH 300 ø296mm (07-14)	KG006WFS	Front	OS	FD344G1375	1	DF006W	SP035	-	-
KAWASAKI	KG208W	Front & Rear	OE	FD164G1396	1	DF208W	-	FD286G1396	DF179W
Kawasaki (2015-) ø280mm	KG208RWSX	Front	OS	FD164G1396R	1	DF208RWSX	SP057	-	-
KAWASAKI 2019 -	KG149W	Front & Rear	OE	FD164G1396	1	DF208W	-	FD286G1396	DF149W
Kawasaki KX (-2014) ø270mm	KG200RFS	Front	OS	FD164G1396	1	DF200FRS	SP005	-	-
Kawasaki KX (-2014) ø270mm	KG200RWS	Front	OS	FD164G1396	1	DF200RW	SP005	-	-
Kawasaki KX (-2014) ø270mm	KG200WFS	Front	OS	FD164G1396	1	DF200FLS	SP005	-	-
Kawasaki KX (-2014) ø270mm	KG200WS	Front	OS	FD164G1396	1	DF208W	SP005	-	-
KTM (2010-) - Husqvarna (2014-) ø240mm	KG607RWS	Rear	OS	-	1	-	SP043	FD291G1396	DF607RWS
KTM (2010-) - Husqvarna (2014-) ø240mm	KG607WS	Rear	OS	-	1	-	SP043	FD291G1396	DF607WS
KTM (2010-) - Husqvarna (2014-) ø270mm	KG606RFS	Front	OS	FD138G1396	1	DF606FRS	SP041	-	-
KTM (2010-) - Husqvarna (2014-) ø270mm	KG606RWS	Front	OS	FD138G1396	1	DF606RWS	SP041	-	-
KTM (2010-) - Husqvarna (2014-) ø270mm	KG606WFS	Front	OS	FD138G1396	1	DF606FLS	SP041	-	-
KTM (2010-) - Husqvarna (2014-) ø270mm	KG606WS	Front	OS	FD138G1396	1	DF606WS	SP041	-	-
KTM (2010-) - Husqvarna (2014-) ø280mm	KG606RWSX	Front	OS	FD138G1396R	1	DF606RWSX	SP058	-	-
KTM 85 SX 260mm	KG794RWS	Front	OS	FD458G1396	1	DF794RWS	SP794	-	-
KTM-HUSQV.	KG606W	Front & Rear	OE	FD138G1396	1	DF606W	-	FD291G1396	DF607W
KTM-HUSQV.	KG606WLL	Front & Rear	OE	FD138G1396	1	DF606W	-	FD291G1396	DF607WLL
SUZUKI	KG368W	Front & Rear	OE	FD164G1396	1	DF368W	-	FD286G1396	DF350W
Suzuki (2018-) ø280mm	KG368RWSX	Front	OS	FD164G1396R	1	DF368RWSX	SP057	-	-
Suzuki RMZ ø270mm	KG349RFS	Front	OS	FD164G1396	1	DF349FRS	SP005	-	-
Suzuki RMZ ø270mm	KG349RWS	Front	OS	FD164G1396	1	DF349RWS	SP005	-	-
Suzuki RMZ ø270mm	KG349WFS	Front	OS	FD164G1396	1	DF349FLS	SP005	-	-
Suzuki RMZ ø270mm	KG349WS	Front	OS	FD164G1396	1	DF349WS	SP005	-	-
TM	KG828W	Front & Rear	OE	FD138G1396	1	DF828W	-	FD286G1396	DF840W
YAMAHA	KG298W	Front & Rear	OE	FD364G1396	1	DF298W	-	FD286G1396	DF499W
Yamaha (2015-) ø280mm	KG298RWSX	Front	OS	FD364G1396R	1	DF298RWSX	SP056	-	-
YAMAHA 2018 -	KG515W	Front & Rear	OE	FD364G1396	1	DF298W	-	FD286G1396	DF515W
Yamaha N MAX 125/150	KG5341FS	Front	OS	FD503G1380	1	DF534FLS	SP048	-	-
Yamaha T-MAX 500 (04-07)	KG5033F	Front & Rear	OE	FD169G1380	2	DF503FLW	-	FD352G1380	DF494W
Yamaha T-MAX 530	KG503CF	Front & Rear	OE	FD178G1370	2	DF503FLW	-	FD260G1380	DF528W
Yamaha T-MAX 530 (2015-) / 560 (2020-) ø298mm	KG495BFS	Front & Rear	OS	FD178G1375	2	DF460CW	SP475	FD260G1380	DF528W
Yamaha T-MAX 530 (2015-) / 560 (2020-) ø298mm	KG495CFS	Front	OS	FD178G1375	2	DF460CW	SP475	-	-
Yamaha T-MAX 530 (2015-) / 560 (2020-) ø320mm	KG4983FS	Front & Rear	OS	FD178G1375	2	DF475CW	SP498	FD260G1380	DF528W
Yamaha X-MAX 125-250	KG500WF	Front & Rear	OE	FD266G1380	1	DF500W	-	FD214G1380	DF524W
Yamaha X-MAX 400	KG5033FLW	Front & Rear	OE	FD266G1370	2	DF503FLW	-	FD474G1380	DF501W
Yamaha YZ 85 ø250mm	KG489RWS	Front	OS	FD097G1054	1	DF489RWS	SP049	-	-
Yamaha YZ 85 ø250mm	KG489WS	Front	OS	FD097G1054	1	DF489WS	SP049	-	-
Yamaha YZF 125 R	KG5262F	Front & Rear	OE	FD138G1054	1	DF526W	-	FD336G1054	DF527W
Yamaha YZF ø270mm	KG301RFS	Front	OS	FD364G1396	1	DF298FRW	SP023	-	-
Yamaha YZF ø270mm	KG301RWS	Front	OS	FD364G1396	1	DF298RW	SP023	-	-
Yamaha YZF ø270mm	KG301WFS	Front	OS	FD364G1396	1	DF298FLW	SP023	-	-
Yamaha YZF ø270mm	KG301WS	Front	OS	FD364G1396	1	DF301WS	SP023	-	-

OE: Original equipment (original replacement disc) · Equipo original (disco de reemplazo del original) · Attrezzatura originale (disco sostitutivo originale) · Équipement d'origine (disque de remplacement d'origine)

OS: Oversized disc (needs bracket to adapt the brake caliper) · Disco sobremedida (necesita soporte para adaptar la pinza de freno) · Disco maggiorato (necessita di supporto per adattare la pinza del freno) · Disque oversized (nécessite un support pour adapter l'étrier de frein)



KITS OFF-ROAD FIXED ORIGINAL SIZE FRONT & REAR (DF W)



KG014W					
FRONT			REAR		
FD164G1396	1	DF014W	-	FD278G1396	DF069W
BRAND & MODEL MARCA Y MODELO				C.C.	YEAR
HONDA					
CR 125 R		125	95	97	
CR 125 R		125	98	01	
CR 125 R		125	02	04	
CR 125 R		125	05	07	
CR 250 R		250	95	96	
CR 250 R		250	97	01	
CR 250 R		250	02	04	
CR 250 R		250	05	07	
CRF 250 R		250	04	07	
CRF 250 R		250	08	14	
CRF 250 X		250	04		
CRF 250 XR LD		250	13		
CRF 450 F/R		450	01	03	
CRF 450 F/R		450	04	07	
CRF 450 F/R		450	08	14	
CRF 450 X		450	04		
CRF 450 XR LD		450	13		
CR 500 R		500	95	00	

KG082W					
FRONT			REAR		
FD164G1396	1	DF082W	-	FD278G1396	DF069W
BRAND & MODEL MARCA Y MODELO				C.C.	YEAR
HONDA RED MOTO					
CRF 250 R		250	15		
CRF 450 R		450	15		
CRF 250 R ENDURO		250	15		
CRF 300 R ENDURO		300	15		
CRF 450 RS		450	15		
CRF 450 RX		450	15		
CRF 450 RX COUNTRY		450	15		
HONDA					
CRF 250 R		250	15		
CRF 450 R		450	15		
CRF450 RX		450	18		
CRF 450 RX COUNTRY		450	17		

KG149W					
FRONT			REAR		
FD164G1396	1	DF208W	-	FD286G1396	DF149W
BRAND & MODEL MARCA Y MODELO				C.C.	YEAR
KAWASAKI					
KX 250 F		250	20		
KX 450 F		450	19		

KG208W					
FRONT			REAR		
FD164G1396	1	DF208W	-	FD286G1396	DF179W
BRAND & MODEL MARCA Y MODELO				C.C.	YEAR
KAWASAKI					
KX 250 F		250	15	19	
KX 450 F		450	15	18	

KG298W					
FRONT			REAR		
FD364G1396	1	DF298W	-	FD286G1396	DF499W
BRAND & MODEL MARCA Y MODELO				C.C.	YEAR
YAMAHA					
YZ 250 F		250	16	17	
YZ 250 F 60th ANNIVERSARY		250	16		
WR 450 F		450	16		
YZ 450 F		450	16	17	
YZ 450 F 60th ANNIVERSARY		450	16		

KG349W					
FRONT			REAR		
FD164G1396	1	DF349W	-	FD286G1396	DF350W
BRAND & MODEL MARCA Y MODELO				C.C.	YEAR
SUZUKI					
RM 250 Z		250	07		
RM 450 Z		450	05		
RMX 450 Z		450	10	17	

KG368W					
FRONT			REAR		
FD164G1396	1	DF368W	-	FD286G1396	DF350W
BRAND & MODEL MARCA Y MODELO				C.C.	YEAR
SUZUKI					
RMX 450 Z		450	18		

KG515W					
FRONT			REAR		
FD364G1396	1	DF298W	-	FD286G1396	DF515W
BRAND & MODEL MARCA Y MODELO				C.C.	YEAR
YAMAHA					
YZ 125		125	18		
YZ 250		250	18		
YZ 250 F		250	18		
YZ 450 F		450	16	19	

KG606W					
FRONT			REAR		
FD138G1396	1	DF606W	-	FD291G1396	DF607W
BRAND & MODEL MARCA Y MODELO				C.C.	YEAR
HUSABERG					
ALL MODELS 125 -570		125-570	11		
HUSQVARNA					
ALL MODELS 125 -501		125-501	14		
KTM					
144 SX		144	08		
150 XC		150	10		
250 EXC F		250	15		
250 SX F		250	15		
300 EXC - E		300	08		
350 ECX F		350	12		
350 SX FACTORY		350	10		
350 SX F		350	11		
350 XC F		350	11		
450 EXC - R		450	08		
450 XC SIX DAYS		450	10		
500 EXC		500	14		
530 EXC - R		530	08		
530 XC / W		530	08		
530 XC SIX DAYS		530	10		

APPLICATIONS
 PADS FD
 DISCS DF
 SHOES MF
 LINES FK
 BRACKETS SP
 KITS KG
 CROSS REFERENCE



KITS OFF-ROAD FIXED ORIGINAL SIZE FRONT & REAR (DF W)

APPLICATIONS

PADS FD

DISCS DF

SHOES MF

LINES FK

BRACKETS SP

KITS KG

CROSS REFERENCE



350 RR efi	350	15	
390 RR 4T	390	15	
400 RR 4T ENDURO	400	13	
430 RR 4T	430	15	
450 RR 4T ENDURO	450	13	
480 RR 4T	480	15	
498 RR 4T ENDURO	498	13	

KG828W

FRONT				REAR	
FD138G1396	1	DF828W	-	FD286G1396	DF840W
BRAND & MODEL MARCA Y MODELO				YEAR	
			C.C.	YEAR	
TM					
EN 125			125	15	
MX 125			125	15	
EN144			144	15	
MX 144			144	15	
EN 250			250	15	
EN 250 F			250	15	
MX 250			250	15	
MX 250 F			250	15	
EN 300			300	15	
MX 300			300	15	
EN 450 F			450	15	
MX 450 F			450	15	
EN 530 F			530	15	
MX 530 F			530	15	

KG606WLL

FRONT				REAR	
FD138G1396	1	DF606W	-	FD291G1396	DF607WLL
BRAND & MODEL MARCA Y MODELO				YEAR	
			C.C.	YEAR	
HUSQVARNA					
ALL MODELS 125 -501			125-501	14	
KTM					
144 SX			144	08	
150 XC			150	10	
250 EXC F			250	15	
250 SX F			250	15	
300 EXC - E			300	08	
350 EXC F			350	12	
350 SX FACTORY			350	10	
350 SX F			350	11	
350 XC F			350	11	
450 EXC - R			450	08	
450 XC SIX DAYS			450	10	
500 EXC			500	14	
530 EXC - R			530	08	
530 XC / W			530	08	
530 XC SIX DAYS			530	10	

KG814W

FRONT				REAR	
FD164G1396	1	DF814W	-	FD456G1396	DF815W
BRAND & MODEL MARCA Y MODELO				YEAR	
			C.C.	YEAR	
BETA					
250 RR 2T ENDURO			250	12	
X-TRAINER			250	18	
300 RR 2T ENDURO			300	13	
XTRAINER			300	15	
350 RR 4T ENDURO			350	13	



KITS OFF-ROAD FIXED OVERSIZE FRONT DISC (DF WS)



KG014WS					
FRONT			REAR		
FD164G1396	1	DF082WS	SP001	-	-
BRAND & MODEL MARCA Y MODELO		C.C.	YEAR		
HIM					
CRE 125 R		125	03		
CRE 250 F		250	03		
CRE 250 R		250	03		
CRF 250 R		250	09		
CRE 250 X		250	09		
CRE 300 X		300	09		
CRE 450 F		450	03		
CRE 450 R		450	09		
CRF 450 R		450	09		
CRE 450 X		450	09		
CRE F 490 X		490	07		
CRE 500 X		500	09		
HONDA					
CR 125 R		125	95	07	
CR 250 R		250	95	07	
CRF 250 R		250	04	14	
CRF 250 X		250	04		
CRF 250 XR LD		250	13		
CRF 450 F/R		450	01	14	
CRF 450 X		450	04		
CRF 450 XR LD		450	13		
CR 500 R		500	95	00	

KG082WS					
FRONT			REAR		
FD164G1396	1	DF082WS	SP045	-	-
BRAND & MODEL MARCA Y MODELO		C.C.	YEAR		
HONDA					
CRF 250 R		250	15	18	
CRF 450 R		450	15	18	

KG082WS2					
FRONT			REAR		
FD164G1396	1	DF082WS	SP059	-	-
BRAND & MODEL MARCA Y MODELO		C.C.	YEAR		
HONDA					
CRF 250 R		250	19		
CRF 450 R		450	19		

KG200WS					
FRONT			REAR		
FD164G1396	1	DF208W	SP005	-	-
BRAND & MODEL MARCA Y MODELO		C.C.	YEAR		
KAWASAKI					
KX 125		125	06		
KX 250		250	06		
KX 250 F		250	06	14	
KLX 450 R		450	07		
KX 450 F		450	06	14	
KXE 450 F		450	06		

KG301WS					
FRONT			REAR		
FD164G1396	1	DF301WS	SP203	-	-
BRAND & MODEL MARCA Y MODELO		C.C.	YEAR		
YAMAHA					
YZ 125		125	08		
YZ 125, WR		125	01	07	
WR 250 F 4T		250	03		
YZ 250		250	08		
YZ 250, WR		250	01	02	
YZ 250 F, WR F 4T		250	01	06	
YZ 250 F		250	07	13	
WR 426 F		425	00	02	
YZ 426 F		425	00	02	
WR 450 F		450	03		
YZ 450 F		450	03		

KG349WS					
FRONT			REAR		
FD164G1396	1	DF349WS	SP005	-	-
BRAND & MODEL MARCA Y MODELO		C.C.	YEAR		
SUZUKI					
RM 250 Z		250	07		
RM 450 Z		450	05		
RMX 450 Z		450	10	17	

KG489WS					
FRONT			REAR		
FD097G1054	1	DF489WS	SP049	-	-
BRAND & MODEL MARCA Y MODELO		C.C.	YEAR		
YAMAHA					
YZ 85 / LW		85	03		

KG606WS					
FRONT			REAR		
FD138G1396	1	DF606WS	SP041	-	-
BRAND & MODEL MARCA Y MODELO		C.C.	YEAR		
HUSABERG					
ALL MODELS 125-570		125-570	11		
HUSQVARNA					
ALL MODELS 125-501		125-501	14		
KTM					
144 SX		144	08		
150 XC		150	10		
250 EXC F		250	15		
250 SX F		250	15		
300 EXC - E		300	08		
350 ECX F		350	12		
350 SX FACTORY		350	10		
350 SX F		350	11		
350 XC F		350	11		
450 EXC - R		450	08		
450 XC SIX DAYS		450	10		
500 EXC		500	14		
530 EXC - R		530	08		
530 XC / W		530	08		
530 XC SIX DAYS		530	10		

KG607WS					
FRONT			REAR		
-	1	-	SP043	FD291G1396	DF607WS
BRAND & MODEL MARCA Y MODELO		C.C.	YEAR		
HUSQVARNA					
ALL MODELS 125-501		125-501	14		
KTM					
144 SX		144	08		
150 XC		150	10		
250 EXC F		250	15		
250 SX F		250	15		
300 EXC - E		300	08		
350 ECX F		350	12		
350 SX FACTORY		350	10		
350 SX F		350	11		
350 XC F		350	11		
450 EXC - R		450	08		
450 XC SIX DAYS		450	10		
500 EXC		500	14		
530 EXC - R		530	08		
530 XC / W		530	08		
530 XC SIX DAYS		530	10		

APPLICATIONS
 PADS FD
 DISCS DF
 SHOES MF
 LINES FK
 BRACKETS SP
 KITS KG
 CROSS REFERENCE



KITS OFF-ROAD FIXED GROOVED OVERSIZE FRONT DISC (DF RWS / RWSX)

APPLICATIONS

PADS FD

DISCS DF

SHOES MF

LINES FK

BRACKETS SP

KITS KG

CROSS REFERENCE



KG014RWS

FRONT				REAR			
FD164G1396	1	DF014RWS	SP001	-	-	-	-
BRAND & MODEL MARCA Y MODELO				C.C.	YEAR		
HONDA							
CRF 250 R				250	03		
CRF 250 F				250	03		
CRF 250 R				250	03		
CRF 250 R				250	09		
CRF 250 X				250	09		
CRF 300 X				300	09		
CRF 450 F				450	03		
CRF 450 R				450	09		
CRF 450 R				450	09		
CRF 450 X				450	09		
CRF F 490 X				490	07		
CRF 500 X				500	09		
HONDA							
CR 125 R				125	95	07	
CR 250 R				250	95	07	
CRF 250 R				250	04	14	
CRF 250 X				250	04		
CRF 250 XR LD				250	13		
CRF 450 F/R				450	01	14	
CRF 450 X				450	04		
CRF 450 XR LD				450	13		
CR 500 R				500	95	00	

KG082RWS

FRONT				REAR			
FD164G1396	1	DF014RWS	SP045	-	-	-	-
BRAND & MODEL MARCA Y MODELO				C.C.	YEAR		
HONDA							
CRF 250 R				250	15	18	
CRF 450 R				450	15	18	

KG082RWS2

FRONT				REAR			
FD164G1396	1	DF014RWS	SP059	-	-	-	-
BRAND & MODEL MARCA Y MODELO				C.C.	YEAR		
HONDA							
CRF 250 R				250	19		
CRF 450 R				450	19		

KG082RWSX

FRONT				REAR			
FD164G1396R	1	DF082RWSX	SP060	-	-	-	-
BRAND & MODEL MARCA Y MODELO				C.C.	YEAR		
HONDA							
CRF 250 R				250	15		
CRF 450 R				450	15		

KG200RWS

FRONT				REAR			
FD164G1396	1	DF208RWS	SP005	-	-	-	-
BRAND & MODEL MARCA Y MODELO				C.C.	YEAR		
KAWASAKI							
KX 125				125	06		
KX 250				250	06		
KX 250 F				250	06	14	
KLX 450 R				450	07		
KX 450 F				450	06	14	
KXE 450 F				450	06		

KG208RWSX

FRONT				REAR			
FD164G1396R	1	DF208RWSX	SP057	-	-	-	-
BRAND & MODEL MARCA Y MODELO				C.C.	YEAR		
KAWASAKI							
KX 250 F				250	15		
KX 450 F				450	15		

KG298RWSX

FRONT				REAR			
FD364G1396R	1	DF298RWSX	SP056	-	-	-	-
BRAND & MODEL MARCA Y MODELO				C.C.	YEAR		
YAMAHA							
YZ 250 F				250	16		
YZ 250 F 60th ANNIVERSARY				250	16		
WR 450 F				450	16		
YZ 450 F				450	16		
YZ 450 F 60th ANNIVERSARY				450	16		

KG301RWS

FRONT				REAR			
FD164G1396	1	DF298RWS	SP203	-	-	-	-
BRAND & MODEL MARCA Y MODELO				C.C.	YEAR		
YAMAHA							
YZ 125				125	08		
YZ 125, WR				125	01	07	
WR 250 F 4T				250	03		
YZ 250				250	08		
YZ 250, WR				250	01	02	
YZ 250 F, WR F 4T				250	01	06	
YZ 250 F				250	07	13	
WR 426 F				425	00	02	
YZ 426 F				425	00	02	
WR 450 F				450	03		
YZ 450 F				450	03		

KG349RWS

FRONT				REAR			
FD164G1396	1	DF349RWS	SP005	-	-	-	-
BRAND & MODEL MARCA Y MODELO				C.C.	YEAR		
SUZUKI							
RM 250 Z				250	07		
RM 450 Z				450	05		
RMX 450 Z				450	10	17	

KG368RWSX

FRONT				REAR			
FD164G1396R	1	DF368RWSX	SP057	-	-	-	-
BRAND & MODEL MARCA Y MODELO				C.C.	YEAR		
SUZUKI							
RMX 450 Z				450	18		



KITS OFF-ROAD FIXED GROOVED OVERSIZE FRONT DISC (DF RWS / RWSX)



KG489RWS

FRONT				REAR	
FD097G1054	1	DF489RWS	SP049	-	-
BRAND & MODEL MARCA Y MODELO				C.C.	YEAR
HUSQVARNA					
ALL MODELS 125 -501				125-501	14
YAMAHA					
YZ 85 / LW				85	03

KG606RWS

FRONT				REAR	
FD138G1396	1	DF606RWS	SP041	-	-
BRAND & MODEL MARCA Y MODELO				C.C.	YEAR
HUSABERG					
ALL MODELS 125 -570				125-570	11
HUSQVARNA					
ALL MODELS 125 -501				125-501	14
KTM					
144 SX				144	08
150 XC				150	10
250 EXC F				250	15
250 SX F				250	15
300 EXC - E				300	08
350 ECX F				350	12
350 SX FACTORY				350	10
350 SX F				350	11
350 XC F				350	11
450 EXC - R				450	08
450 XC SIX DAYS				450	10
500 EXC				500	14
530 EXC - R				530	08
530 XC / W				530	08
530 XC SIX DAYS				530	10

KG606RWSX

FRONT				REAR	
FD138G1396R	1	DF606RWSX	SP058	-	-
BRAND & MODEL MARCA Y MODELO				C.C.	YEAR
HUSQVARNA					
ALL MODELS 125 -501				125-501	14
KTM					
ALL MODELS 150 -530				150-530	11

KG607RWS

FRONT				REAR	
-	1	-	SP043	FD291G1396	DF607RWS
BRAND & MODEL MARCA Y MODELO				C.C.	YEAR
HUSQVARNA					
ALL MODELS 125 -501				125-501	14
KTM					
144 SX				144	08
150 XC				150	10
250 EXC F				250	15
250 SX F				250	15
300 EXC - E				300	08
350 ECX F				350	12
350 SX FACTORY				350	10
350 SX F				350	11
350 XC F				350	11
450 EXC - R				450	08
450 XC SIX DAYS				450	10
500 EXC				500	14
530 EXC - R				530	08
530 XC / W				530	08
530 XC SIX DAYS				530	10

KG794RWS

FRONT				REAR	
FD459G1396	1	DF794RWS	SP794	-	-
BRAND & MODEL MARCA Y MODELO				C.C.	YEAR
HUSQVARNA					
85 TC 19/16				85	14
KTM					
85 SX 19/16				85	13
150 SX 19/16				150	15

APPLICATIONS

PADS FD

DISCS DF

SHOES MF

LINES FK

BRACKETS SP

KITS KG

CROSS REFERENCE



KITS OFF-ROAD FLOATING OVERSIZE FRONT DISC (DF FLS)

APPLICATIONS

PADS FD

DISCS DF

SHOES MF

LINES FK

BRACKETS SP

KITS KG

CROSS REFERENCE



KG014WFS

FRONT				REAR	
FD164G1396	1	DF014FLS	SP001	-	-
BRAND & MODEL MARCA Y MODELO		C.C.	YEAR		

HM					
CRE 125 R	125	03			
CRE 250 F	250	03			
CRE 250 R	250	03			
CRF 250 R	250	09			
CRE 250 X	250	09			
CRE 300 X	300	09			
CRE 450 F	450	03			
CRE 450 R	450	09			
CRF 450 R	450	09			
CRE 450 X	450	09			
CRE F 490 X	490	07			
CRE 500 X	500	09			

HONDA					
CR 125 R	125	95	07		
CR 250 R	250	95	07		
CRF 250 R	250	04	14		
CRF 250 X	250	04			
CRF 250 XR LD	250	13			
CRF 450 F/R	450	01	14		
CRF 450 X	450	04			
CRF 450 XR LD	450	13			
CR 500 R	500	95	00		

KG082WFS

FRONT				REAR	
FD164G1396	1	DF014FLS	SP045	-	-
BRAND & MODEL MARCA Y MODELO		C.C.	YEAR		

HONDA					
CRF 250 R	250	15	18		
CRF 450 R	450	15	18		

KG082WFS2

FRONT				REAR	
FD164G1396	1	DF014FLS	SP059	-	-
BRAND & MODEL MARCA Y MODELO		C.C.	YEAR		

HONDA					
CRF 250 R	250	19			
CRF 450 R	450	19			

KG200WFS

FRONT				REAR	
FD164G1396	1	DF200FLS	SP005	-	-
BRAND & MODEL MARCA Y MODELO		C.C.	YEAR		

KAWASAKI					
KX 125	125	06			
KX 250	250	06			
KX 250 F	250	06	14		
KLX 450 R	450	07			
KX 450 F	450	06	14		
KXE 450 F	450	06			

KG301WFS

FRONT				REAR	
FD164G1396	1	DF298FLW	SP203	-	-
BRAND & MODEL MARCA Y MODELO		C.C.	YEAR		

YAMAHA					
YZ 125	125	08			
YZ 125, WR	125	01	07		
WR 250 F 4T	250	03			
YZ 250	250	08			
YZ 250, WR	250	01	02		
YZ 250 F, WR F 4T	250	01	06		
YZ 250 F	250	07	13		
WR 426 F	425	00	02		
YZ 426 F	425	00	02		
WR 450 F	450	03			
YZ 450 F	450	03			

KG349WFS

FRONT				REAR	
FD164G1396	1	DF349FLS	SP005	-	-
BRAND & MODEL MARCA Y MODELO		C.C.	YEAR		

SUZUKI					
RM 250 Z	250	07			
RM 450 Z	450	05			
RMX 450 Z	450	10	17		

KG606WFS

FRONT				REAR	
FD138G1396	1	DF606FLS	SP041	-	-
BRAND & MODEL MARCA Y MODELO		C.C.	YEAR		

HUSABERG					
ALL MODELS 125 -570	125-570	11			

HUSQVARNA					
ALL MODELS 125-501	125-501	14			

KTM					
144 SX	144	08			
150 XC	150	10			
250 EXC F	250	15			
250 SX F	250	15			
300 EXC - E	300	08			
350 EXC F	350	12			
350 SX FACTORY	350	10			
350 SX F	350	11			
350 XC F	350	11			
450 EXC - R	450	08			
450 XC SIX DAYS	450	10			
500 EXC	500	14			
530 EXC - R	530	08			
530 XC / W	530	08			
530 XC SIX DAYS	530	10			

KG677WFS

FRONT				REAR	
FD164G1396	1	DF677FLS	SP027	-	-
BRAND & MODEL MARCA Y MODELO		C.C.	YEAR		

GAS GAS					
EC 125	125	01	15		
EC 125 SIX DAYS	125	11			
HALLEY 125	125	09			
MC 125	125	01			
EC 200 / SIX DAYS	200	01			
EC 250	250	01			
EC 250 E / F / FSE	250	11			
EC 250 RACING / SIX DAYS	250	09			
EC 250 YR	250	12			
MC 250	250	01			
EC 300 / E / F / SIX DAYS	300	01			
EC 300 RACING	300	09			
EC 400 FSE	400	01			
PAMPERA 400	400	06			
EC 450 F	450	15			
EC 450 FSE	450	03			



KITS OFF-ROAD FLOATING GROOVED OVERSIZE FRONT DISC (DF FR)



KG014RFS

FRONT				REAR	
FD164G1396	1	DF014FRS	SP001	-	-
BRAND & MODEL MARCA Y MODELO				C.C.	YEAR

HM					
CRE 125 R	125	03			
CRE 250 F	250	03			
CRE 250 R	250	03			
CRF 250 R	250	09			
CRE 250 X	250	09			
CRE 300 X	300	09			
CRE 450 F	450	03			
CRE 450 R	450	09			
CRF 450 R	450	09			
CRE 450 X	450	09			
CRE F 490 X	490	07			
CRE 500 X	500	09			

HONDA					
CR 125 R	125	95	07		
CR 250 R	250	95	07		
CRF 250 R	250	04	14		
CRF 250 X	250	04			
CRF 250 XR LD	250	13			
CRF 450 F/R	450	01	14		
CRF 450 X	450	04			
CRF 450 XR LD	450	13			
CR 500 R	500	95	00		

KG082RFS

FRONT				REAR	
FD164G1396	1	DF014FRS	SP045	-	-
BRAND & MODEL MARCA Y MODELO				C.C.	YEAR

HONDA					
CRF 250 R	250	15	18		
CRF 450 R	450	15	18		

KG082RFS2

FRONT				REAR	
FD164G1396	1	DF014FRS	SP059	-	-
BRAND & MODEL MARCA Y MODELO				C.C.	YEAR

HONDA					
CRF 250 R	250	19			
CRF 450 R	450	19			

KG200RFS

FRONT				REAR	
FD164G1396	1	DF200FRS	SP005	-	-
BRAND & MODEL MARCA Y MODELO				C.C.	YEAR

KAWASAKI					
KX 125	125	06			
KX 250	250	06			
KX 250 F	250	06	14		
KLX 450 R	450	07			
KX 450 F	450	06	14		
KXE 450 F	450	06			

KG301RFS

FRONT				REAR	
FD164G1396	1	DF298FRW	SP203	-	-
BRAND & MODEL MARCA Y MODELO				C.C.	YEAR

YAMAHA					
YZ 125	125	08			
YZ 125, WR	125	01	07		
WR 250 F 4T	250	03			
YZ 250	250	08			
YZ 250, WR	250	01	02		
YZ 250 F, WR F 4T	250	01	06		
YZ 250 F	250	07	13		
WR 426 F	425	00	02		
YZ 426 F	425	00	02		
WR 450 F	450	03			
YZ 450 F	450	03			

KG349RFS

FRONT				REAR	
FD164G1396	1	DF349FRS	SP005	-	-
BRAND & MODEL MARCA Y MODELO				C.C.	YEAR

SUZUKI					
RM 250 Z	250	07			
RM 450 Z	450	05			
RMX 450 Z	450	10	17		

KG606RFS

FRONT				REAR	
FD138G1396	1	DF606FRS	SP041	-	-
BRAND & MODEL MARCA Y MODELO				C.C.	YEAR

HUSABERG					
ALL MODELS 125 -570	125-570	11			

HUSQVARNA					
ALL MODELS 125-501	125-501	14			

KTM					
144 SX	144	08			
150 XC	150	10			
250 EXC F	250	15			
250 SX F	250	15			
300 EXC - E	300	08			
350 EXC F	350	12			
350 SX FACTORY	350	10			
350 SX F	350	11			
350 XC F	350	11			
450 EXC - R	450	08			
450 XC SIX DAYS	450	10			
500 EXC	500	14			
530 EXC - R	530	08			
530 XC / W	530	08			
530 XC SIX DAYS	530	10			

KG677RFS

FRONT				REAR	
FD164G1396	1	DF677FRS	SP027	-	-
BRAND & MODEL MARCA Y MODELO				C.C.	YEAR

GAS GAS					
EC 125	125	01	15		
EC 125 SIX DAYS	125	11			
HALLEY 125	125	09			
MC 125	125	01			
EC 200 / SIX DAYS	200	01			
EC 250	250	01			
EC 250 E / F / FSE	250	11			
EC 250 RACING / SIX DAYS	250	09			
EC 250 YR	250	12			
MC 250	250	01			
EC 300 / E / F / SIX DAYS	300	01			
EC 300 RACING	300	09			
EC 400 FSE	400	01			
PAMPERA 400	400	06			
EC 450 F	450	15			
EC 450 FSE	450	03			

KG920RFS

FRONT				REAR	
FD138G1396	1	DF772FRW	SP047	-	-
BRAND & MODEL MARCA Y MODELO				C.C.	YEAR

SHERCO					
250-450 SE FORK WP	250-450	14			

APPLICATIONS

PADS DF

DISCS DF

SHOES MF

LINES FK

BRACKETS SP

KITS KG

CROSS REFERENCE



KITS ROAD FRONT (ORIGINAL OR OVERSIZE FRONT DISC)

APPLICATIONS

PADS FD

DISCS DF

SHOES MF

LINES FK

BRACKETS SP

KITS KG

CROSS REFERENCE



DYLAN 150	150	02	
PS 150i	150	06	
SH 150 SCOOPY	150	01	04
SH 150 i SCOOPY	150	05	
SH 150 i SCOOPY (TAMBOR TRAS)	150	09	

KG078WF

FRONT				REAR			
FD439G1383	1	DF078W	-	-	-	-	-
BRAND & MODEL MARCA Y MODELO		C.C.	YEAR	C.C.		YEAR	
HONDA							
NSC 50 AC		50	13				
NSC 50 C		50	13				
NSC 50 R		50	13				
VISION 50		50	12				
VISION 110 AC		110	11				
VISION 110 WHB		110	11				
PCX 125		125	10				
SH 125 MODE		125	13				
PCX 150		150	13				

KG7022F

FRONT				REAR			
FD271G1375	2	DF702W	-	-	-	-	-
BRAND & MODEL MARCA Y MODELO		C.C.	YEAR	C.C.		YEAR	
BMW							
R 1150 GS		1150	02				
R 1200 GS		1200	04			08	
R 1200 GS		1200	09				
R 1200 GS ADVENTURE		1200	06			08	
R 1200 GS ADVENTURE		1200	09				

KG006WFS

FRONT				REAR			
FD344G1375	1	DF006W	SP035	-	-	-	-
BRAND & MODEL MARCA Y MODELO		C.C.	YEAR	C.C.		YEAR	
HONDA							
SH SCOOPY 300		300	07	14			
SH SCOOPY 300 ABS		300	07	14			

KG083WF

FRONT				REAR			
FD344G1054	1	DF083W	-	-	-	-	-
BRAND & MODEL MARCA Y MODELO		C.C.	YEAR	C.C.		YEAR	
HONDA							
SH SCOOPY 300		300	07				
SH SCOOPY 300 ABS		300	07				

KG702WFS

FRONT				REAR			
FD475G1370	2	DF707W	SP707	-	-	-	-
BRAND & MODEL MARCA Y MODELO		C.C.	YEAR	C.C.		YEAR	
BMW							
R 1200 GS LC		1200	13				
R 1200 GS LC ADVENTURE		1200	13				

KG007WFS

FRONT				REAR			
FD344G1380	1	DF007WS	SP035	-	-	-	-
BRAND & MODEL MARCA Y MODELO		C.C.	YEAR	C.C.		YEAR	
HONDA							
SH 125 i SCOOPY (D-D)		125	09	12			
SH 125 i SCOOPY ABS		125	13				
SH 150 i SCOOPY (D-D)		150	09				
SH 150 i SCOOPY ABS		150	13				
FAZE 250		250	10				
FES 250 FORZA EX		250	05				
FES 250 FORZA X / Z		250	05				
NSS 300 FORZA		300	13				

KG473WFS

FRONT				REAR			
FD153G1054	1	DF473WS	SP009	-	-	-	-
BRAND & MODEL MARCA Y MODELO		C.C.	YEAR	C.C.		YEAR	
MBK MOTOBKANE							
BOOSTER NAKED		50	06				
BOOSTER WHEEL 12"		50	06				
YAMAHA							
BW'S NAKED		50	06				
BW'S WHEEL 12"		50	06				

KG071WFS

FRONT				REAR			
FD284G1380	1	DF071WS	SP025	-	-	-	-
BRAND & MODEL MARCA Y MODELO		C.C.	YEAR	C.C.		YEAR	
HONDA							
@ 125		125	00				
DYLAN 125		125	02				
PS 125i		125	06				
SH 125 SCOOPY		125	01	04			
SH 125 i SCOOPY		125	05	08			
SH 125 i SCOOPY (TAMBOR TRAS)		125	09	12			
@ 150		150	00				

KG5341FS

FRONT				REAR			
FD503G1380	1	DF534FLS	SP048	-	-	-	-
BRAND & MODEL MARCA Y MODELO		C.C.	YEAR	C.C.		YEAR	
YAMAHA							
N MAX 125 ABS		125	15				
N MAX 150 ABS		150	15				



KITS ROAD FRONT & REAR (ORIGINAL OR OVERSIZE FRONT DISC)

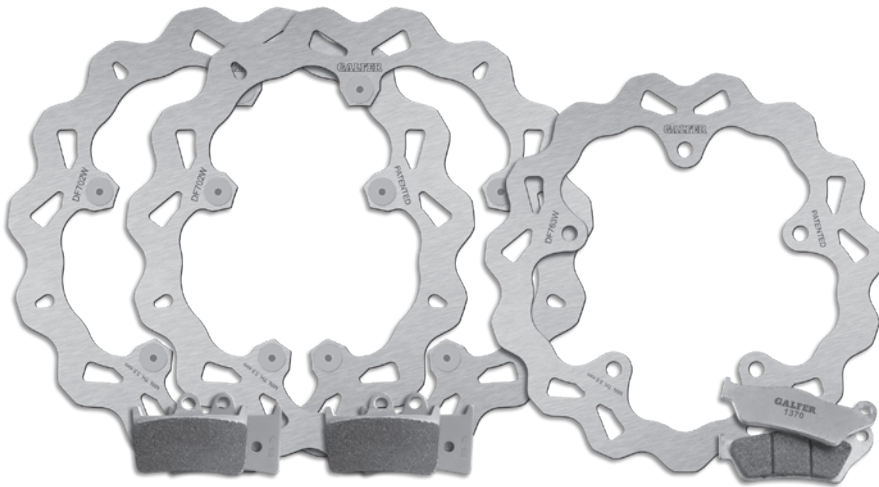

KG0062FS

FRONT				REAR			
FD344G1375	1	DF006W	SP035	FD345G1054	DF083W		
BRAND & MODEL MARCA Y MODELO				C.C.	YEAR		
HONDA							
SH SCOOPIY 300				300	07		
SH SCOOPIY 300 ABS				300	07		

KG0072FS

FRONT				REAR			
FD344G1380	1	DF007WS	SP035	FD345G1054	DF007W		
BRAND & MODEL MARCA Y MODELO				C.C.	YEAR		
HONDA							
SH 125 i SCOOPIY (D-D)				125	09	12	
SH 125 i SCOOPIY ABS				125	13		
SH 150 i SCOOPIY (D-D)				150	09		
SH 150 i SCOOPIY ABS				150	13		
FAZE 250				250	10		
FES 250 FORZA EX				250	05		
FES 250 FORZA X / Z				250	05		
NSS 300 FORZA				300	13		

KG495BFS

FRONT				REAR			
FD178G1375	2	DF460CW	SP475	FD260G1380	DF528W		
BRAND & MODEL MARCA Y MODELO				C.C.	YEAR		
YAMAHA							
XP 530 T-MAX				530	15		
XP 530 T-MAX ABS				530	15		
XP 560 T-MAX				560	20		
XP 560 T-MAX TECH MAX				560	20		

KG4983FS

FRONT				REAR			
FD178G1375	2	DF475CW	SP498	FD260G1380	DF528W		
BRAND & MODEL MARCA Y MODELO				C.C.	YEAR		
YAMAHA							
XP 530 T-MAX				530	15		
XP 530 T-MAX ABS				530	15		
XP 560 T-MAX				560	20		
XP 560 T-MAX TECH MAX				560	20		

KG500WF

FRONT				REAR			
FD266G1380	1	DF500W	-	FD214G1380	DF524W		
BRAND & MODEL MARCA Y MODELO				C.C.	YEAR		
MBK MOTOBKANE							
SKYCRUISER				125	06	09	
YAMAHA							
X - MAX 125				125	10		
X - MAX 125 ABS				125	10		
X - MAX 250				250	10		

KG5033F

FRONT				REAR			
FD169G1380	2	DF503FLW	-	FD352G1380	DF494W		
BRAND & MODEL MARCA Y MODELO				C.C.	YEAR		
YAMAHA							
XP 500 T-MAX				500	04	07	
XP 500 T-MAX ABS				500	07		
XP 500 T-MAX BLACK MAX				500	07		

KG5033FLW

FRONT				REAR			
FD266G1370	2	DF503FLW	-	FD474G1380	DF501W		
BRAND & MODEL MARCA Y MODELO				C.C.	YEAR		
YAMAHA							
X - MAX 400				400	13		

KG503CF

FRONT				REAR			
FD178G1370	2	DF503FLW	-	FD260G1380	DF528W		
BRAND & MODEL MARCA Y MODELO				C.C.	YEAR		
YAMAHA							
XP 530 T-MAX				530	12		
XP 530 T-MAX ABS				530	12		
XP 560 T-MAX				560	20		
XP 560 T-MAX TECH MAX				560	20		

KG5262F

FRONT				REAR			
FD138G1054	1	DF526W	-	FD336G1054	DF527W		
BRAND & MODEL MARCA Y MODELO				C.C.	YEAR		
YAMAHA							
YZF 125 R				125	08		

KG7023F

FRONT				REAR			
FD271G1375	2	DF702W	-	FD186G1371	DF763W		
BRAND & MODEL MARCA Y MODELO				C.C.	YEAR		
BMW							
R 1150 GS				1150	02		
R 1200 GS				1200	04 08		
R 1200 GS				1200	09		
R 1200 GS ADVENTURE				1200	06 08		
R 1200 GS ADVENTURE				1200	09		

KG8163F

FRONT				REAR			
FD266G1370	2	DF816FLW	-	FD266G1370	DF816W		
BRAND & MODEL MARCA Y MODELO				C.C.	YEAR		
BMW							
C 600 SPORT				600	12		
C 650 GT				650	12		

GALFER

NEW OVERSIZED BRAKE KIT FOR OFF-ROAD



**NEW
ADAPTERS**



Racing
G1396R



KIT RWSX Ø280mm

AVAILABLE FOR:

- **KTM** (2011-)
- **HONDA** (2015-)
- **SUZUKI** (2018-)
- **YAMAHA** (2016-)
- **KAWASAKI** (2015-)
- **HUSQVARNA** (2014-)

Developed for Racing and used by AMA SX riders in USA

**SAME SHAPE PADS
DIFFERENT THICKNESS**

**PASTILLAS MISMA FORMA
DIFERENTE ESPESOR**

**PASTIGLIE STESSA FORMA
SPESSORE DIVERSO**

**PLAQUETTES MÊME FORME
ÉPAISSEUR DIFFÉRENTE**

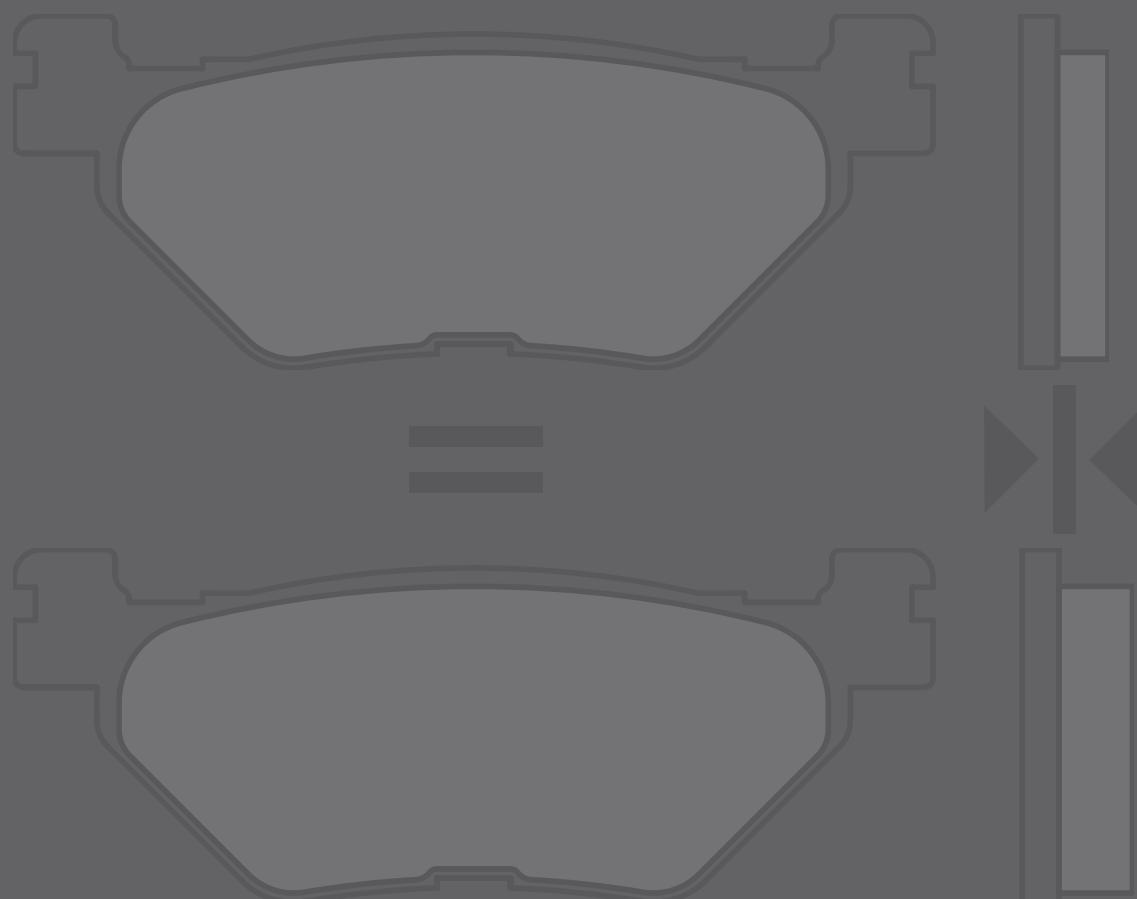



APPLICATIONS

PADS **FD**

DISCS **DF**

SHOES **MF**

LINES **FK**

BRACKETS **SP**

KITS **KG**

CROSS REFERENCE

GALFER ref.	Thickness mm.	= GALFER ref.	Thickness mm.	= GALFER ref.	Thickness mm.	GALFER ref.	Thickness mm.
FD012	7,00	FD170	7,30	FD190	9,30		
FD045	9,00	FD111	8,60				
FD063	7,20	FD284	9,30				
FD070	9,50	FD209	7,00				
FD076	7,80	FD299	6,50				
FD086	7,7 / 7,5	FD187	8,50	FD524	9,20		
FD093	10,00	FD147	7,00	FD144	8,90		
FD100	9,00	FD148	8,50				
FD103	10,60	FD457	9,00				
FD111	8,60	FD045	9,00				
FD117	7,50	FD145	9,20	FD532	8,4/8,5		
FD138	7,60	FD186	8,5 / 10,1				
FD140	9,80	FD266	8,30				
FD144	8,90	FD093	10,00	FD147	7,00		
FD145	9,20	FD117	7,50	FD532	8,4/8,5		
FD147	7,00	FD144	8,90	FD093	10,00		
FD148	8,50	FD100	9,00				
FD168	8,40	FD208	10,00				
FD170	7,30	FD012	7,00	FD190	9,30		
FD186	8,5 / 10,1	FD138	7,60				
FD187	8,50	FD086	7,7/7,5	FD524	9,20		
FD190	9,30	FD012	7,00	FD170	7,30		
FD193	9,50	FD384	8,00				
FD205	7,50	FD207	9,40				
FD207	9,40	FD205	7,50				
FD208	10,00	FD168	8,40				
FD209	7,00	FD070	9,50				
FD260	11,80	FD295	9,50				
FD266	8,30	FD140	9,80				
FD270	6,80	FD410	5,25				
FD284	9,30	FD063	7,20				
FD286	10,50	FD456	9,00				
FD295	9,50	FD260	11,80				
FD299	6,50	FD076	7,80				
FD384	8,00	FD193	9,50				
FD410	5,25	FD270	6,80				
FD446	5,80	FD458	7,30				
FD456	9,00	FD286	10,50				
FD457	9,00	FD103	10,60				
FD458	7,30	FD446	5,80				
FD493	8,80	FD504	6,90				
FD492	8,80	FD540	6,90				
FD504	6,90	FD493	8,80				
FD524	9,20	FD086	7,7/7,5	FD187	8,50		
FD532	8,4/8,5	FD145	9,2/9,2	FD117	7,7/7,5		
FD540	6,90	FD492	8,80				

PADS CROSS REFERENCES
CRUCE REFERENCIAS PASTILLAS
COMPARATIVA CODICI PASTIGLIE
CORRESPONDANCES RÉFÉRENCES PLAQUETTES



FROM THE WEBSITE **GALFERMOTO.COM**
THROUGH THE **GALFER ONLINE** MENU TAB

DIRECTLY AT **GALFERONLINE.ES**

FINDING



redirect →



BY **MOTORCYCLE MODEL**

BY **ARTICLE REFERENCE**

SEARCHING



EXCLUSIVE FOR **PROFESSIONAL CUSTOMERS**
WITH **USER & PASSWORD**

ACCESS DATA FOR:

LOGIN



USER

PASSWORD*

* First access requests changing the password for security reasons.

On-line catalogue and electronic commerce: **www.galferonline.es**

Here you can find the following advantages and benefits:

- The applications catalogue and all GALFER articles with pictures and technical data always updated.
- **Public access to the catalogue:** by motorcycle model or by article. Retail price suggested shown (excluding VAT).
- **Professional login:** on line orders, check stock status, sales terms, orders history, etc...
- Latest new brake products featured on the homepage.

galferonline.es





DESDE LA PÁGINA WEB **GALFERMOTO.COM**
A TRAVÉS DE LA PESTAÑA **GALFER ONLINE**

COMO LLEGAR



redirección →

DIRECTAMENTE EN **GALFERONLINE.ES**



POR MODELO DE MOTOCICLETA

COMO BUSCAR



POR REFERENCIA DE ARTÍCULO



EXCLUSIVO PARA CLIENTES PROFESIONALES
CON USUARIO Y CONTRASEÑA

COMO ACCEDER



DATOS DE ACCESO PARA:

USUARIO

CONTRASEÑA*

* El primer acceso al sistema se solicita modificar la contraseña por cuestiones de seguridad.

Servicio de catálogo y comercio electrónico en Internet: **www.galferonline.es**

En él podrá encontrar las siguientes ventajas y utilidades:

- El catálogo de aplicaciones y todos los artículos GALFER con sus imágenes y datos técnicos siempre actualizados.
- **Acceso público en modo catálogo** para búsquedas por modelo de moto o por referencias de artículos con visualización del precios PVP (sin IVA).
- **Acceso restringido para profesionales** para realizar pedidos según sus condiciones de venta, ver el estado de sus pedidos, ver información de stocks, hacer consultas de historial, ...
- Las últimas novedades de productos de freno destacados en la página principal.



galferonline.es



The pictures, drawings and all the information contained in this catalog isn't binding in any case, and don't give the right to claim or compensation by the customer. The values shown are for reference. Industries Galfer reserves the right to make changes to their products without prior notice. All trademarks appearing in this catalog are understood only as a reference for use the GALFER products as spare parts for motorcycles.

Design and production: MARKETING dep. of Industrias Galfer. Printed: GRADIEN TRES, S.L.

2020 © INDUSTRIAS GALFER, S.A.

Las imágenes, dibujos e información contenida en este catálogo no será vinculante en ningún caso, ni dará derecho a reclamación o indemnización alguna por parte del cliente. Los valores que aparecen son de referencia. Industrias Galfer se reserva el derecho a efectuar modificaciones de sus productos sin previo aviso. Todas las marcas registradas que aparecen en este catálogo se entienden exclusivamente como una referencia para la utilización de los productos GALFER como recambios para motocicletas.

Diseño y producción: Dep. MARKETING de Industrias Galfer. Impresión: GRADIEN TRES, S.L.

© INDUSTRIAS GALFER, S.A. 2020

PASSION NEVER STOPS

DISTRIBUTOR • DISTRIBUIDOR
DISTRIBUITO • DISTRIBUÏ



Made in
SPAIN

INDUSTRIAS GALFER S.A.

c/ ctra. de Montmeló, 50 · Circuit de Catalunya
08403 Granollers · BARCELONA (SPAIN)
Tel: +34 93 568 90 90 · Fax: +34 93 568 90 83
info@galfer.es · www.galfermoto.com

Website
galfermoto.com



Ecommerce
galferonline.es



GALFER

PERFORMANCE BRAKING SYSTEMS

GALFER USA

4388 N. Carson Street · Carson City NV 89706
Ph. 805 988 2900 · Fx. 805 988 2948
corporate@galferusa.com
www.galferusa.com

Ref. 9503501

